

NVM Express

Revision 1.1
October 11, 2012

Please send comments to Amber Huffman
amber.huffman@intel.com

NVM Express revision 1.1 specification available for download at <http://nvmexpress.org>.

SPECIFICATION DISCLAIMER

THIS SPECIFICATION IS PROVIDED TO YOU "AS IS" WITH NO WARRANTIES WHATSOEVER, INCLUDING ANY WARRANTY OF MERCHANTABILITY, NON-INFRINGEMENT, OR FITNESS FOR ANY PARTICULAR PURPOSE. THE AUTHORS OF THIS SPECIFICATION DISCLAIM ALL LIABILITY, INCLUDING LIABILITY FOR INFRINGEMENT OF ANY PROPRIETARY RIGHTS, RELATING TO USE OR IMPLEMENTATION OF INFORMATION IN THIS SPECIFICATION. THE AUTHORS DO NOT WARRANT OR REPRESENT THAT SUCH USE WILL NOT INFRINGE ANY SUCH RIGHTS. THE PROVISION OF THIS SPECIFICATION TO YOU DOES NOT PROVIDE YOU WITH ANY LICENSE, EXPRESS OR IMPLIED, BY ESTOPPEL OR OTHERWISE, TO ANY INTELLECTUAL PROPERTY RIGHTS.

Copyright 2007-2012, Intel Corporation. All rights reserved.

All product names, trademarks, registered trademarks, and/or servicemarks may be claimed as the property of their respective owners.

NVMHCI Workgroup Chair:

Amber Huffman
Intel Corporation
MS: JF5-371
2111 NE 25th Avenue
Hillsboro, OR 97124
amber.huffman@intel.com

Table of Contents

1	INTRODUCTION	8
1.1	Overview	8
1.2	Scope	8
1.3	Outside of Scope	8
1.4	Theory of Operation	8
1.4.1	Multi-Path I/O and Namespace Sharing	10
1.5	Conventions	13
1.6	Definitions	14
1.6.1	Admin Queue	14
1.6.2	arbitration burst	14
1.6.3	arbitration mechanism	14
1.6.4	candidate command	14
1.6.5	command completion	14
1.6.6	command submission	14
1.6.7	controller	14
1.6.8	extended LBA	14
1.6.9	firmware slot	14
1.6.10	I/O command	14
1.6.11	I/O Completion Queue	14
1.6.12	I/O Submission Queue	14
1.6.13	LBA range	15
1.6.14	logical block	15
1.6.15	logical block address (LBA)	15
1.6.16	metadata	15
1.6.17	namespace	15
1.6.18	Namespace ID	15
1.6.19	NVM	15
1.6.20	NVM subsystem	15
1.6.21	private namespace	15
1.6.22	shared namespace	15
1.7	Keywords	15
1.7.1	mandatory	15
1.7.2	may	15
1.7.3	optional	16
1.7.4	R	16
1.7.5	reserved	16
1.7.6	shall	16
1.7.7	should	16
1.8	Conventions	16
1.9	Byte, word and Dword Relationships	17
1.10	References	17
1.11	References Under Development	18
2	SYSTEM BUS (PCI EXPRESS) REGISTERS	19
2.1	PCI Header	19
2.1.1	Offset 00h: ID - Identifiers	20
2.1.2	Offset 04h: CMD - Command	20
2.1.3	Offset 06h: STS - Device Status	20
2.1.4	Offset 08h: RID - Revision ID	20
2.1.5	Offset 09h: CC - Class Code	21
2.1.6	Offset 0Ch: CLS – Cache Line Size	21
2.1.7	Offset 0Dh: MLT – Master Latency Timer	21
2.1.8	Offset 0Eh: HTYPE – Header Type	21
2.1.9	Offset 0Fh: BIST – Built In Self Test (Optional)	21
2.1.10	Offset 10h: MLBAR (BAR0) – Memory Register Base Address, lower 32-bits	21
2.1.11	Offset 14h: MUBAR (BAR1) – Memory Register Base Address, upper 32-bits	22
2.1.12	Offset 18h: IDBAR (BAR2) – Index/Data Pair Register Base Address (Optional)	22

2.1.13	Offset 1Ch – 20h: BAR3 –Reserved.....	22
2.1.14	Offset 20h – 23h: BAR4 – Vendor Specific	22
2.1.15	Offset 24h – 27h: BAR5 – Vendor Specific	22
2.1.16	Offset 28h: CCPTR – CardBus CIS Pointer	22
2.1.17	Offset 2Ch: SS - Sub System Identifiers	22
2.1.18	Offset 30h: EROM – Expansion ROM (Optional)	22
2.1.19	Offset 34h: CAP – Capabilities Pointer.....	22
2.1.20	Offset 3Ch: INTR - Interrupt Information	23
2.1.21	Offset 3Eh: MGNT – Minimum Grant	23
2.1.22	Offset 3Fh: MLAT – Maximum Latency	23
2.2	PCI Power Management Capabilities.....	23
2.2.1	Offset PMCAP: PID - PCI Power Management Capability ID.....	23
2.2.2	Offset PMCAP + 2h: PC – PCI Power Management Capabilities.....	23
2.2.3	Offset PMCAP + 4h: PMCS – PCI Power Management Control and Status	24
2.3	Message Signaled Interrupt Capability (Optional).....	24
2.3.1	Offset MSICAP: MID – Message Signaled Interrupt Identifiers	24
2.3.2	Offset MSICAP + 2h: MC – Message Signaled Interrupt Message Control.....	24
2.3.3	Offset MSICAP + 4h: MA – Message Signaled Interrupt Message Address	25
2.3.4	Offset MSICAP + 8h: MUA – Message Signaled Interrupt Upper Address.....	25
2.3.5	Offset MSICAP + Ch: MD – Message Signaled Interrupt Message Data	25
2.3.6	Offset MSICAP + 10h: MMASK – Message Signaled Interrupt Mask Bits (Optional)	25
2.3.7	Offset MSICAP + 14h: MPEND – Message Signaled Interrupt Pending Bits (Optional).....	25
2.4	MSI-X Capability (Optional)	25
2.4.1	Offset MSIXCAP: MXID – MSI-X Identifiers	25
2.4.2	Offset MSIXCAP + 2h: MXC – MSI-X Message Control.....	26
2.4.3	Offset MSIXCAP + 4h: MTAB – MSI-X Table Offset / Table BIR	26
2.4.4	Offset MSIXCAP + 8h: MPBA – MSI-X PBA Offset / PBA BIR.....	26
2.5	PCI Express Capability (Optional)	27
2.5.1	Offset PXCAP: PXID – PCI Express Capability ID	27
2.5.2	Offset PXCAP + 2h: PXCAP – PCI Express Capabilities	27
2.5.3	Offset PXCAP + 4h: PXDCAP – PCI Express Device Capabilities.....	27
2.5.4	Offset PXCAP + 8h: PXDC – PCI Express Device Control	28
2.5.5	Offset PXCAP + Ah: PXDS – PCI Express Device Status.....	29
2.5.6	Offset PXCAP + Ch: PXLCAP – PCI Express Link Capabilities	29
2.5.7	Offset PXCAP + 10h: PXLC – PCI Express Link Control	30
2.5.8	Offset PXCAP + 12h: PMLS – PCI Express Link Status.....	30
2.5.9	Offset PXCAP + 24h: PXDCAP2 – PCI Express Device Capabilities 2.....	30
2.5.10	Offset PXCAP + 28h: PXDC2 – PCI Express Device Control 2	31
2.6	Advanced Error Reporting Capability (Optional)	31
2.6.1	Offset AERCAP: AERID – AER Capability ID	32
2.6.2	Offset AERCAP + 4: AERUCES – AER Uncorrectable Error Status Register.....	32
2.6.3	Offset AERCAP + 8: AERUCEM – AER Uncorrectable Error Mask Register.....	32
2.6.4	Offset AERCAP + Ch: AERUCESEV – AER Uncorrectable Error Severity Register.....	33
2.6.5	Offset AERCAP + 10h: AERCS – AER Correctable Error Status Register.....	33
2.6.6	Offset AERCAP + 14h: AERCEM – AER Correctable Error Mask Register	34
2.6.7	Offset AERCAP + 18h: AERCC – AER Capabilities and Control Register	34
2.6.8	Offset AERCAP + 1Ch: AERHL – AER Header Log Register	35
2.6.9	Offset AERCAP + 38h: AERTLP – AER TLP Prefix Log Register (Optional)	35
2.7	Other Capability Pointers.....	35
3	CONTROLLER REGISTERS	36
3.1	Register Definition	36
3.1.1	Offset 00h: CAP – Controller Capabilities	37
3.1.2	Offset 08h: VS – Version.....	38
3.1.3	Offset 0Ch: INTMS – Interrupt Mask Set.....	38
3.1.4	Offset 10h: INTMC – Interrupt Mask Clear	38
3.1.5	Offset 14h: CC – Controller Configuration.....	38
3.1.6	Offset 1Ch: CSTS – Controller Status	40
3.1.7	Offset 20h: NSSR – NVM Subsystem Reset.....	41
3.1.8	Offset 24h: AQA – Admin Queue Attributes	41
3.1.9	Offset 28h: ASQ – Admin Submission Queue Base Address.....	41

3.1.10	Offset 30h: ACQ – Admin Completion Queue Base Address	42
3.1.11	Offset (1000h + ((2y) * (4 << CAP.DSTRD))): SQyTDBL – Submission Queue y Tail Doorbell	42
3.1.12	Offset (1000h + ((2y + 1) * (4 << CAP.DSTRD))): CQyHDBL – Completion Queue y Head Doorbell ..	42
3.2	Index/Data Pair registers (Optional)	42
3.2.1	Restrictions	43
3.2.2	Register Definition	43
3.2.3	Offset 00h: IDX – Index Register.....	43
3.2.4	Offset 04h: DAT – Data Register.....	43
4	SYSTEM MEMORY STRUCTURES	44
4.1	Submission Queue & Completion Queue Definition.....	44
4.1.1	Empty Queue	45
4.1.2	Full Queue.....	45
4.1.3	Queue Size	45
4.1.4	Queue Identifier.....	46
4.1.5	Queue Priority	46
4.2	Submission Queue Entry – Command Format.....	46
4.3	Physical Region Page Entry and List	49
4.4	Scatter Gather List (SGL)	50
4.4.1	SGL Example	53
4.5	Metadata Region (MR)	55
4.6	Completion Queue Entry	55
4.6.1	Status Field Definition	56
4.7	Fused Operations	60
4.8	Command Arbitration.....	60
4.8.1	Round Robin Arbitration	61
4.8.2	Weighted Round Robin with Urgent Priority Class Arbitration	61
4.8.3	Vendor Specific Arbitration.....	63
5	ADMIN COMMAND SET	64
5.1	Abort command	65
5.1.1	Command Completion.....	65
5.2	Asynchronous Event Request command	66
5.2.1	Command Completion.....	66
5.3	Create I/O Completion Queue command	68
5.3.1	Command Completion.....	69
5.4	Create I/O Submission Queue command.....	69
5.4.1	Command Completion.....	70
5.5	Delete I/O Completion Queue command	71
5.5.1	Command Completion.....	71
5.6	Delete I/O Submission Queue command	71
5.6.1	Command Completion.....	72
5.7	Firmware Activate command	72
5.7.1	Command Completion.....	73
5.8	Firmware Image Download command.....	73
5.8.1	Command Completion.....	74
5.9	Get Features command	74
5.9.1	Select field.....	75
5.9.2	Command Completion.....	76
5.10	Get Log Page command	76
5.10.1	Log Specific Information	77
5.10.1.4.1	Reservation Notification (Log Identifier 80h)	81
5.10.2	Command Completion.....	82
5.11	Identify command.....	82
5.11.1	Command Completion.....	94
5.12	Set Features command.....	94
5.12.1	Feature Specific Information	95
5.12.2	Command Completion.....	105
5.13	Format NVM command – NVM Command Set Specific.....	105

5.13.1	Command Completion.....	106
5.14	Security Receive command – NVM Command Set Specific	107
5.14.1	Command Completion.....	107
5.14.2	Security Protocol 00h.....	108
5.15	Security Send command – NVM Command Set Specific.....	108
5.15.1	Command Completion.....	109
6	NVM COMMAND SET	110
6.1	Namespaces.....	110
6.2	Fused Operations	111
6.2.1	Compare and Write	111
6.3	Command Ordering Requirements and Atomic Write Unit.....	111
6.4	End-to-end Protection Information.....	112
6.5	Compare command.....	112
6.5.1	Command Completion.....	114
6.6	Dataset Management command	114
6.6.2	Command Completion.....	117
6.7	Flush command	117
6.7.1	Command Completion.....	117
6.8	Read command	117
6.8.1	Command Completion.....	120
6.9	Reservation Acquire command	120
6.9.1	Command Completion.....	121
6.10	Reservation Register command.....	121
6.10.1	Command Completion.....	123
6.11	Reservation Release command.....	123
6.11.1	Command Completion.....	124
6.12	Reservation Report command	124
6.12.1	Command Completion.....	126
6.13	Write command.....	126
6.13.1	Command Completion.....	128
6.14	Write Uncorrectable command	128
6.14.1	Command Completion.....	129
6.15	Write Zeroes command.....	129
6.15.1	Command Completion.....	130
7	CONTROLLER ARCHITECTURE	131
7.1	Introduction	131
7.2	Command Submission and Completion Mechanism (Informative)	131
7.2.1	Command Processing.....	131
7.2.2	Basic Steps when Building a Command.....	132
7.2.3	Processing Completed Commands	133
7.2.4	Command Related Resource Retirement.....	133
7.2.5	Command Examples	133
7.3	Resets.....	138
7.3.1	NVM Subsystem Reset	138
7.3.2	Controller Level	138
7.3.3	Queue Level.....	139
7.4	Queue Management.....	139
7.4.1	Queue Allocation.....	139
7.4.2	Queue Coordination.....	140
7.4.3	Queue Abort.....	140
7.5	Interrupts.....	140
7.5.1	Pin Based, Single MSI, and Multiple MSI Behavior	141
7.5.1.1	Host Software Interrupt Handling	141
7.5.1.1.1	Interrupt Example (Informative).....	142
7.5.1.2	Differences Between Pin Based and MSI Interrupts.....	142
7.5.2	MSI-X Based Behavior	142

7.6	Controller Initialization and Shutdown Processing	143
7.6.1	Initialization	143
7.6.1.1	Software Progress Marker.....	144
7.6.2	Shutdown	144
7.7	Feature Values	145
7.8	Unique Identifier.....	145
8	FEATURES.....	147
8.1	Firmware Update Process	147
8.2	Metadata Handling.....	147
8.3	End-to-end Data Protection (Optional)	148
8.4	Power Management.....	152
8.4.1	Autonomous Power State Transitions	153
8.5	Single Root I/O Virtualization and Sharing (SR-IOV)	154
8.6	Doorbell Stride for Software Emulation	154
8.7	Standard Vendor Specific Command Format.....	154
8.8	Reservations (Optional)	155
8.8.1	Reservation Notifications.....	156
8.8.2	Reservation Notifications.....	156
8.8.3	Reservation Types	157
8.8.4	Unregistering	158
8.8.5	Acquiring a Reservation	159
8.8.6	Releasing a Reservation	159
8.8.7	Preempting a Reservation or Registration.....	159
8.8.8	Clearing a Reservation	160
8.8.9	Reporting Reservation Status	161
9	ERROR REPORTING AND RECOVERY	162
9.1	Command and Queue Error Handling	162
9.2	Media and Data Error Handling	162
9.3	System Memory Error Handling	162
9.4	Internal Device Error Handling	162
9.5	Controller Fatal Status Condition.....	162

1 Introduction

1.1 Overview

NVM Express (NVMe) is a register level interface that allows host software to communicate with a non-volatile memory subsystem. This interface is optimized for Enterprise and Client solid state drives, typically attached to the PCI Express interface.

Note: During development, this specification was referred to as Enterprise NVMHCI. However, the name was modified to NVM Express prior to specification completion. This interface is targeted for use in both Client and Enterprise systems.

1.2 Scope

The specification defines a register interface for communication with a non-volatile memory subsystem. It also defines a standard command set for use with the NVM subsystem.

1.3 Outside of Scope

The register interface and command set are specified apart from any usage model for the NVM, but rather only specifies the communication interface to the NVM subsystem. Thus, this specification does not specify whether the non-volatile memory system is used as a solid state drive, a main memory, a cache memory, a backup memory, a redundant memory, etc. Specific usage models are outside the scope, optional, and not licensed.

This interface is specified above any non-volatile memory management, like wear leveling. Erases and other management tasks for NVM technologies like NAND are abstracted.

This specification does not contain any information on caching algorithms or techniques.

The implementation or use of other published specifications referred to in this specification, even if required for compliance with the specification, are outside the scope of this specification (for example, PCI, PCI Express and PCI-X).

1.4 Theory of Operation

NVM Express is a scalable host controller interface designed to address the needs of Enterprise and Client systems that utilize PCI Express based solid state drives. The interface provides optimized command submission and completion paths. It includes support for parallel operation by supporting up to 64K I/O Queues with up to 64K commands per I/O Queue. Additionally, support has been added for many Enterprise capabilities like end-to-end data protection (compatible with T10 DIF and SNIA DIX standards), enhanced error reporting, and virtualization.

The interface has the following key attributes:

- Does not require uncacheable / MMIO register reads in the command submission or completion path.
- A maximum of one MMIO register write is necessary in the command submission path.
- Support for up to 64K I/O queues, with each I/O queue supporting up to 64K commands.
- Priority associated with each I/O queue with well-defined arbitration mechanism.
- All information to complete a 4KB read request is included in the 64B command itself, ensuring efficient small I/O operation.
- Efficient and streamlined command set.
- Support for MSI/MSI-X and interrupt aggregation.
- Support for multiple namespaces.
- Efficient support for I/O virtualization architectures like SR-IOV.
- Robust error reporting and management capabilities.
- Support for multi-path I/O and namespace sharing.

This specification defines a streamlined set of registers whose functionality includes:

- Indication of controller capabilities
- Status for controller failures (command status is processed via CQ directly)
- Admin Queue configuration (I/O Queue configuration processed via Admin commands)
- Doorbell registers for scalable number of Submission and Completion Queues

An NVM Express controller is associated with a single PCI Function. The capabilities that a controller supports are indicated in the Controller Capabilities (CAP) register and as part of the Controller and Namespace data structures returned by the Identify command. The Identify Controller data structure indicates capabilities and settings that apply to the entire controller. The Identify Namespace data structure indicates capabilities and settings that are specific to a particular namespace.

NVM Express is based on a paired Submission and Completion Queue mechanism. Commands are placed by host software into a Submission Queue. Completions are placed into the associated Completion Queue by the controller. Multiple Submission Queues may utilize the same Completion Queue. Submission and Completion Queues are allocated in host memory.

An Admin Submission and associated Completion Queue exist for the purpose of controller management and control (e.g., creation and deletion of I/O Submission and Completion Queues, aborting commands, etc.) Only commands that are part of the Admin Command Set may be submitted to the Admin Submission Queue.

An I/O Command Set is used with an I/O queue pair. This specification defines one I/O Command Set, named the NVM Command Set. The host selects one I/O Command Set that is used for all I/O queue pairs.

Host software creates queues, up to the maximum supported by the controller. Typically the number of command queues created is based on the system configuration and anticipated workload. For example, on a four core processor based system, there may be a queue pair per core to avoid locking and ensure data structures are created in the appropriate processor core's cache. Figure 1 provides a graphical representation of the queue pair mechanism, showing a 1:1 mapping between Submission Queues and Completion Queues. Figure 2 shows an example where multiple I/O Submission Queues utilize the same I/O Completion Queue on Core B. Figure 1 and Figure 2 show that there is always a 1:1 mapping between the Admin Submission Queue and Admin Completion Queue.

Figure 1: Queue Pair Example, 1:1 Mapping

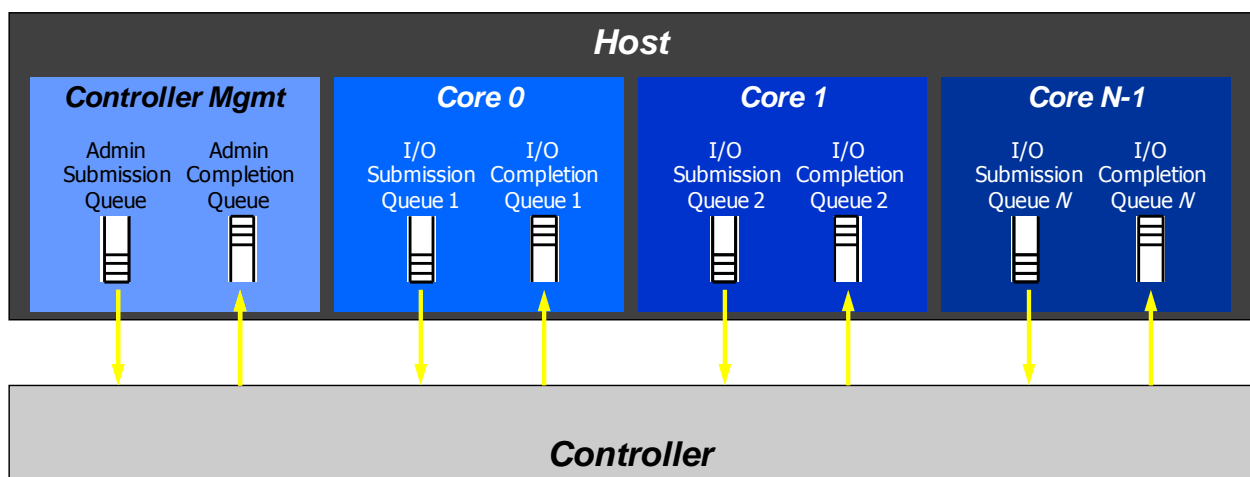
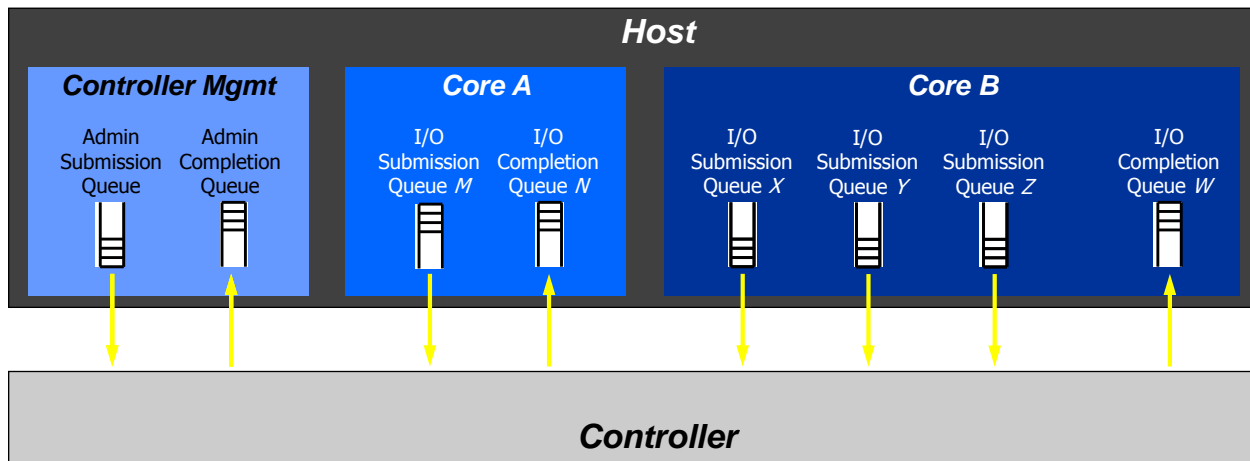

Figure 2: Queue Pair Example, $n:1$ Mapping

A Submission Queue (SQ) is a circular buffer with a fixed slot size that the host software uses to submit commands for execution by the controller. The host software updates the appropriate SQ Tail doorbell register when there are one to n new commands to execute. The previous SQ Tail value is overwritten in the controller when there is a new doorbell register write. The controller fetches SQ entries in order from the Submission Queue, however, it may then execute those commands in any order.

Each Submission Queue entry is a command. Commands are 64 bytes in size. The physical memory locations in host memory to use for data transfers are specified using Physical Region Page (PRP) entries or Scatter Gather Lists. Each command may include two PRP entries or one Scatter Gather List (SGL) segment. If more than two PRP entries are necessary to describe the data buffer, then a pointer to a PRP List that describes a list of PRP entries is provided. If more than one SGL segment is necessary to describe the data buffer, then the SGL segment provides a pointer to the next SGL segment.

A Completion Queue (CQ) is a circular buffer with a fixed slot size used to post status for completed commands. A completed command is uniquely identified by a combination of the associated SQ identifier and command identifier that is assigned by host software. Multiple Submission Queues may be associated with a single Completion Queue. This feature may be used where a single worker thread processes all command completions via one Completion Queue even when those commands originated from multiple Submission Queues. The CQ Head pointer is updated by host software after it has processed completion queue entries indicating the last free CQ entry. A Phase (P) bit is defined in the completion queue entry to indicate whether an entry has been newly posted without consulting a register. This enables host software to determine whether the new entry was posted as part of the previous or current round of completion notifications. Specifically, each round through the Completion Queue entries, the controller inverts the Phase bit.

1.4.1 Multi-Path I/O and Namespace Sharing

This section provides an overview of multi-path I/O and namespace sharing. Multi-path I/O refers to two or more completely independent physical PCI Express paths between a single host and a namespace while namespace sharing refers to the ability for two or more hosts to access a common shared namespace using different NVM Express controllers. Both multi-path I/O and namespace sharing require that the NVM subsystem contain two or more controllers. Concurrent access to a shared namespace by two or more hosts requires some form of coordination between hosts. The procedure used to coordinate these hosts is outside the scope of this specification.

Figure 3 shows an NVM subsystem that contains a single NVM Express controller and a single PCI Express port. Since this is a single Function PCI Express device, the NVM Express controller shall be associated with PCI Function 0. A controller may support multiple namespaces. The controller in Figure

x1 supports two namespaces labeled NS A and NS B. Associated with each controller namespace is a namespace ID, labeled as NSID 1 and NSID 2, that is used by the controller to reference a specific namespace. The namespace ID is distinct from the namespace itself and is the handle a host and controller use to specify a particular namespace in a command. The mapping of a controller's namespace IDs to namespaces is outside the scope of this specification. In this example namespace ID 1 is associated with namespace A and namespace ID 2 is associated with namespace B. Both namespaces are private to the controller and this configuration supports neither multi-path I/O nor namespace sharing.

Figure 3: NVM Express Controller with Two Namespaces

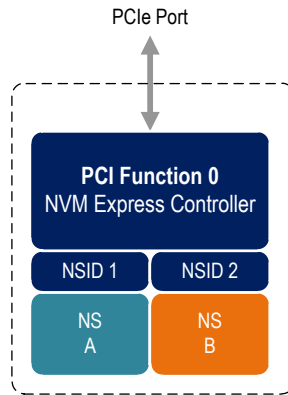
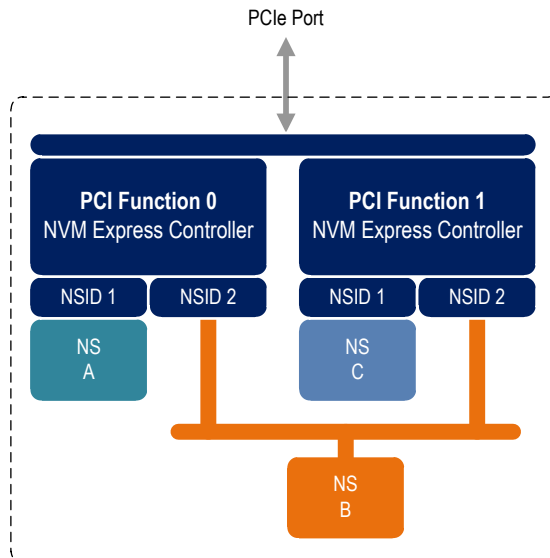

Figure 4 shows a multi-Function NVM Subsystem with a single PCI Express port containing two controllers, one controller is associated with PCI Function 0 and the other controller is associated with PCI Function 1. Each controller supports a single private namespace and access to shared namespace B. The namespace ID shall be the same in all controllers that have access to a particular shared namespace. In this example both controllers use namespace ID 2 to access shared namespace B.

Figure 4: NVM Subsystem with Two Controller and One Port



There is a unique Identify Controller data structure for each controller and a unique Identify Namespace data structure for each namespace. Controllers with access to a shared namespace return the Identify Namespace data structure associated with that shared namespace (i.e., the same data structure contents are returned by all controllers with access to the same shared namespace). The IEEE Extended Unique Identifier (EUI64) field in the Identify Namespace data structure is a globally unique name associated with the namespace itself and may be used to determine when two or more controllers have access to the same shared namespace.

Controllers associated with a shared namespace may operate on the namespace concurrently. Operations performed by individual controllers are atomic to the shared namespace at the write atomicity level of the controller to which the command was submitted (refer to section 6.3). The write atomicity level is not required to be the same across controllers that share a namespace. If there are any ordering requirements between commands issued to different controllers that access a shared namespace, then host software or an associated application, is required to enforce these ordering requirements.

Figure 5 illustrates an NVM Subsystem with two PCI Express ports each with an associated controller. Both controllers map to PCI Function 0 of the corresponding port. Each PCI Express port in this example is completely independent and has its own PCI Express Fundamental Reset and reference clock input. A reset of a port only affects the controller associated with that port and has no impact on the other controller, shared namespace, or operations performed by the other controller on the shared namespace. The functional behavior of this example is otherwise the same as that illustrated in Figure 4.

Figure 5: NVM Subsystem with Two Controller and Two Ports

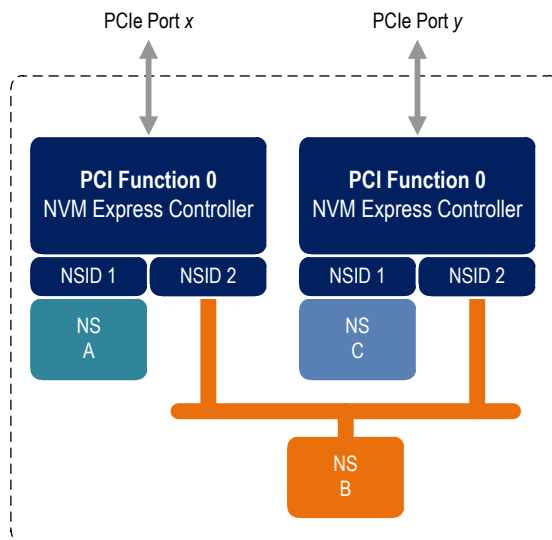

The two ports shown in Figure 5 may be associated with the same Root Complex or with different Root Complexes and may be used to implement both multi-path I/O and I/O sharing architectures. System-level architectural aspects and use of multiple ports in a PCI Express fabric are beyond the scope of this specification.

Figure 6 illustrates an NVM Subsystem that supports Single Root I/O Virtualization (SR-IOV) and has one Physical Function and four Virtual Functions. An NVM Express controller is associated with each Virtual Function with each controller having a private namespace and access to a namespace shared by all controllers, labeled NS E. The behavior of the controllers in this example parallels that of the other examples in this section. Refer to section 8.5 for more information on SR-IOV.

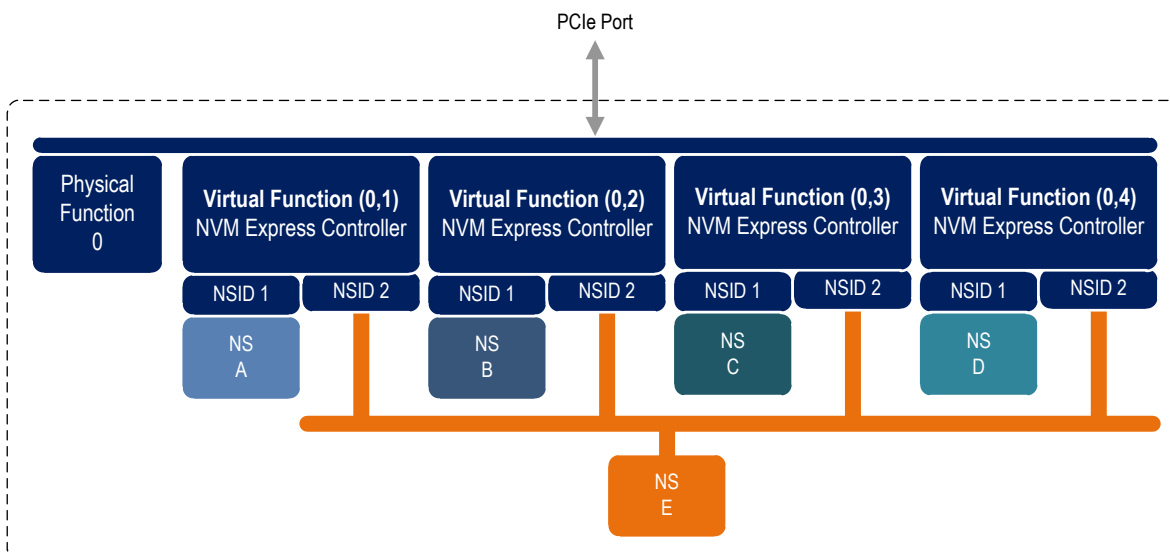
Figure 6: PCI Express Device Supporting Single Root I/O Virtualization (SR-IOV)

Examples provided in this section are meant to illustrate concepts and are not intended to enumerate all possible configurations. For example, an NVM subsystem may contain multiple PCI Express ports with each port supporting SR-IOV.

1.5 Conventions

Hardware shall return '0' for all bits and registers that are marked as reserved, and host software shall write all reserved bits and registers with the value of '0'.

Inside the register section, the following abbreviations are used:

RO	Read Only
RW	Read Write
R/W	Read Write. The value read may not be the last value written.
RWC	Read/Write '1' to clear
RWS	Read/Write '1' to set
Impl Spec	Implementation Specific – the controller has the freedom to choose its implementation.
HwInit	The default state is dependent on device and system configuration. The value is initialized at reset, for example by an expansion ROM, or in the case of integrated devices, by a platform BIOS.

For some register fields, it is implementation specific as to whether the field is RW, RWC, or RO; this is typically shown as RW/RO or RWC/RO to indicate that if the functionality is not supported that the field is read only.

When a register bit is referred to in the document, the convention used is "Register Symbol.Field Symbol". For example, the PCI command register parity error response enable bit is referred to by the name CMD.PEE. If the register field is an array of bits, the field is referred to as "Register Symbol.Field Symbol (array offset)".

When a memory field is referred to in the document, the convention used is "Register Name [Offset Symbol]".

Some fields or registers are 0's based values. In a 0's based value, the value of 0h corresponds to 1; other values similarly correspond to the value+1.

1.6 Definitions

1.6.1 Admin Queue

The Admin Queue is the Submission Queue and Completion Queue with identifier 0. The Admin Submission Queue and corresponding Admin Completion Queue are used to submit administrative commands and receive completions for those administrative commands, respectively.

The Admin Submission Queue is uniquely associated with the Admin Completion Queue.

1.6.2 arbitration burst

The maximum number of commands that may be launched at one time from a Submission Queue that is using round robin or weighted round robin arbitration.

1.6.3 arbitration mechanism

The method used to determine which Submission Queue is selected next to launch commands for execution by the controller. Three arbitration mechanisms are defined including round robin, weighted round robin with urgent priority class, and vendor specific. Refer to section 4.8.

1.6.4 candidate command

A candidate command is a submitted command the controller deems ready for processing.

1.6.5 command completion

A command is completed when the controller has completed processing the command, has updated status information in the completion queue entry, and has posted the completion queue entry to the associated Completion Queue.

1.6.6 command submission

A command is submitted when a Submission Queue Tail Doorbell write has completed that moves the Submission Queue Tail Pointer value past the corresponding Submission Queue entry for the associated command.

1.6.7 controller

A PCI Express function that implements NVM Express.

1.6.8 extended LBA

An extended LBA is a larger LBA that is created when metadata associated with the LBA is transferred contiguously with the LBA data. Refer to Figure 177.

1.6.9 firmware slot

A firmware slot is a location in the controller used to store a firmware image. The controller stores between one and seven firmware images. When downloading new firmware to the controller, host software has the option of specifying which image is replaced by indicating the firmware slot number.

1.6.10 I/O command

An I/O command is a command submitted to an I/O Submission Queue.

1.6.11 I/O Completion Queue

An I/O Completion Queue is a Completion Queue that is used to indicate command completions and is associated with one or more I/O Submission Queues. I/O Completion Queue identifiers are from 1 to 65535.

1.6.12 I/O Submission Queue

An I/O Submission Queue is a Submission Queue that is used to submit I/O commands for execution by the controller (e.g. Read, Write for the NVM command set). I/O Submission Queue identifiers are from 1 to 65535.

1.6.13 LBA range

A collection of contiguous logical blocks specified by a starting LBA and number of logical blocks.

1.6.14 logical block

The smallest addressable data unit for Read and Write commands.

1.6.15 logical block address (LBA)

The address of a logical block, referred to commonly as LBA.

1.6.16 metadata

Metadata is contextual information about a particular LBA of data. The host may include metadata to be stored by the NVM subsystem if storage space is provided by the controller.

1.6.17 namespace

A quantity of non-volatile memory that may be formatted into logical blocks. When formatted, a namespace of size n is a collection of logical blocks with logical block addresses from 0 to $(n-1)$.

1.6.18 Namespace ID

An identifier used by a controller to provide access to a namespace. An invalid namespace ID is a namespace ID whose value is zero or whose value is greater than the value reported by the Number of Namespaces (NN) field in the Identify Controller data structure. All other namespace IDs are valid. A valid namespace ID that maps to a namespace is an active namespace ID. A valid namespace ID that does not map to a namespace is an inactive namespace ID.

1.6.19 NVM

NVM is an acronym for non-volatile memory.

1.6.20 NVM subsystem

An NVM subsystem includes one or more controllers, one or more namespaces, one or more PCI Express ports, a non-volatile memory storage medium, and an interface between the controller(s) and non-volatile memory storage medium.

1.6.21 private namespace

A namespace that is accessible by only one controller. A host may determine whether a namespace is a private namespace or may be a shared namespace by the value of the Namespace Multi-path I/O and Namespace Sharing Capabilities (NMIC) field in the Identify Namespace data structure.

1.6.22 shared namespace

A namespace that is accessible by two or more controllers in an NVM subsystem. A host may determine whether a namespace is a private namespace or may be a shared namespace by the value of the Namespace Multi-path I/O and Namespace Sharing Capabilities (NMIC) field in the Identify Namespace data structure.

1.7 Keywords

Several keywords are used to differentiate between different levels of requirements.

1.7.1 mandatory

A keyword indicating items to be implemented as defined by this specification.

1.7.2 may

A keyword that indicates flexibility of choice with no implied preference.

1.7.3 optional

A keyword that describes features that are not required by this specification. However, if any optional feature defined by the specification is implemented, the feature shall be implemented in the way defined by the specification.

1.7.4 R

“R” is used as an abbreviation for “reserved” when the figure or table does not provide sufficient space for the full word “reserved”.

1.7.5 reserved

A keyword indicating reserved bits, bytes, words, fields, and opcode values that are set-aside for future standardization. Their use and interpretation may be specified by future extensions to this or other specifications. A reserved bit, byte, word, field, or register shall be cleared to zero, or in accordance with a future extension to this specification. The recipient shall not check reserved bits, bytes, words, or fields.

1.7.6 shall

A keyword indicating a mandatory requirement. Designers are required to implement all such mandatory requirements to ensure interoperability with other products that conform to the specification.

1.7.7 should

A keyword indicating flexibility of choice with a strongly preferred alternative. Equivalent to the phrase “it is recommended”.

1.8 Conventions

A 0-based value is a numbering scheme for which the number 0h actually corresponds to a value of 1h and thus produces the pattern of 0h = 1h, 1h = 2h, 2h = 3h, etc. In this numbering scheme, there is not a method for specifying the value of 0h.

Some parameters are defined as a string of ASCII characters. ASCII data fields shall contain only code values 20h through 7Eh. For the string “Copyright”, the character “C” is the first byte, the character “o” is the second byte, etc. The string is left justified and shall be padded with spaces (ASCII character 20h) to the right if necessary.

1.9 Byte, word and Dword Relationships

Figure 7 illustrates the relationship between bytes, words and Dwords. A Qword (quadruple word) is a unit of data that is four times the size of a word; it is not illustrated due to space constraints. This specification specifies data in a little endian format.

Figure 7: Byte, word and Dword Relationships

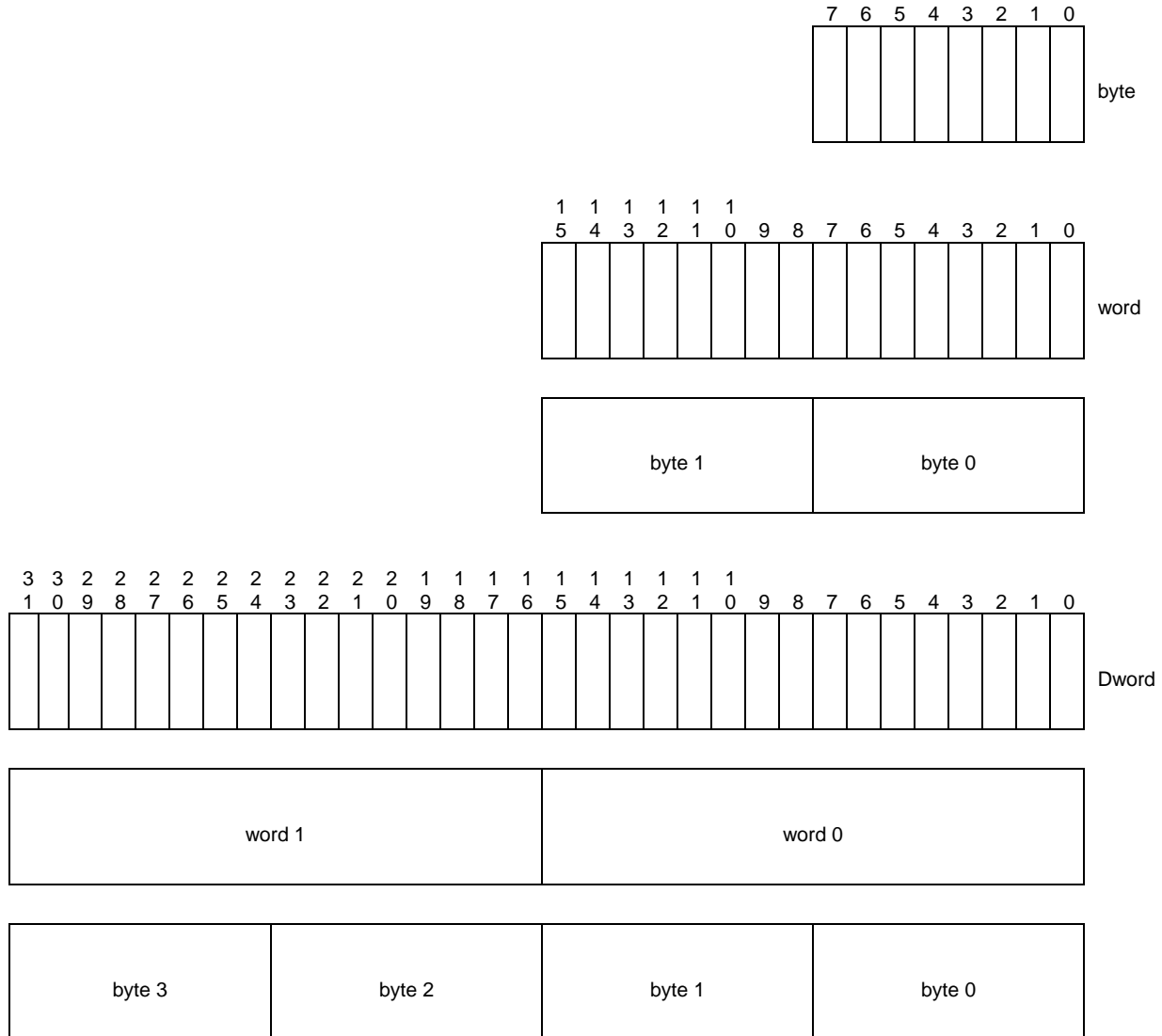

1.10 References

PCI specification, revision 3.0. Available from <http://www.pcisig.com>.

PCI Express specification, revision 2.1. Available from <http://www.pcisig.com>.

PCI Power Management specification. Available from <http://www.pcisig.com>.

PCI Single Root I/O Virtualization, revision 1.1. Available from http://www.pcisig.com/specifications/iov/single_root/.

PCI Firmware 3.0 specification. Available from <http://www.pcisig.com>.

UEFI 2.3.1 specification. Available from <http://www.uefi.org>.

Trusted Computing Group Storage Architecture Core specification. Available from <http://www.trustedcomputinggroup.org>.

JEDEC JESD218: Solid State Drive (SSD) Requirements and Endurance Test Method standard. Available from <http://www.jedec.org>.

1.11 References Under Development

ATA/ATAPI Command Set - 2 (ACS-2) [INCITS T13/2015-D]. Available from <http://www.t13.org>.

ISO/IEC 14776-323, SCSI Block Commands - 3 (SBC-3) [T10/1799-D]. Available from <http://www.t10.org>.

ISO/IEC 14776-454, SCSI Primary Commands - 4 (SPC-4) [T10/1731-D] Available from <http://www.t10.org>.

Trusted Computing Group Storage Interface Interactions Specification (SIIS). Available from <http://www.trustedcomputinggroup.org>.

2 System Bus (PCI Express) Registers

This section describes the PCI Express register values when the PCI Express is the system bus used. Other system buses may be used in an implementation. If a system bus is used that is not a derivative of PCI, then this section is not applicable.

This section details how the PCI Header, PCI Capabilities, and PCI Express Extended Capabilities should be constructed for an NVM Express device. The fields shown are duplicated from the appropriate PCI or PCI Express specifications. The PCI documents are the normative specifications for these registers and this section details additional requirements for an NVM Express device.

Start	End	Name	Type
00h	3Fh	PCI Header	
PMCAP	PMCAP+7h	PCI Power Management Capability	PCI Capability
MSICAP	MSICAP+9h	Message Signaled Interrupt Capability	PCI Capability
MSIXCAP	MSIXCAP+Bh	MSI-X Capability	PCI Capability
PXCAP	PXCAP+29h	PCI Express Capability	PCI Capability
AERCAP	AERCAP+47h	Advanced Error Reporting Capability	PCI Express Extended Capability

MSI-X is the recommended interrupt mechanism to use. However, some systems do not support MSI-X, thus devices should support both the MSI Capability and the MSI-X Capability.

It is recommended that implementations support the Advanced Error Reporting Capability to enable more robust error handling.

2.1 PCI Header

Start	End	Symbol	Name
00h	03h	ID	Identifiers
04h	05h	CMD	Command Register
06h	07h	STS	Device Status
08h	08h	RID	Revision ID
09h	0Bh	CC	Class Codes
0Ch	0Ch	CLS	Cache Line Size
0Dh	0Dh	MLT	Master Latency Timer
0Eh	0Eh	HTYPE	Header Type
0Fh	0Fh	BIST	Built In Self Test (Optional)
10h	13h	MLBAR (BAR0)	Memory Register Base Address, lower 32-bits <BAR0>
14h	17h	MUBAR (BAR1)	Memory Register Base Address, upper 32-bits <BAR1>
18h	1Bh	IDBAR (BAR2)	Index/Data Pair Register Base Address <BAR2> (Optional)
1Ch	1Fh	BAR3	Reserved <BAR3>
20h	23h	BAR4	Vendor Specific
24h	27h	BAR5	Vendor Specific
28h	2Bh	CCPTR	CardBus CIS Pointer
2Ch	2Fh	SS	Subsystem Identifiers
30h	33h	EROM	Expansion ROM Base Address (Optional)
34h	34h	CAP	Capabilities Pointer
35h	3Bh	R	Reserved
3Ch	3Dh	INTR	Interrupt Information
3Eh	3Eh	MGNT	Minimum Grant (Optional)
3Fh	3Fh	MLAT	Maximum Latency (Optional)

2.1.1 Offset 00h: ID - Identifiers

Bits	Type	Reset	Description
31:16	RO	Impl Spec	Device ID (DID): Indicates the device number assigned by the vendor. Specific to each implementation.
15:00	RO	Impl Spec	Vendor ID (VID): Indicates the company vendor, assigned by the PCI SIG.

2.1.2 Offset 04h: CMD - Command

Bit	Type	Reset	Description
15:11	RO	0	Reserved
10	RW	0	Interrupt Disable (ID): Disables the controller from generating pin-based INTx# interrupts. This bit does not have any effect on MSI operation.
09	RO	0	Fast Back-to-Back Enable (FBE): Not supported by NVM Express.
08	RW / RO	0	SERR# Enable (SEE): Controls error reporting.
07	RO	0	Hardwired to 0.
06	RW / RO	0	Parity Error Response Enable (PEE): When set to '1', the controller shall generate PERR# when a data parity error is detected. If parity is not supported, then this field is read-only '0'.
05	RO	0	VGA Palette Snooping Enable (VGA): Not supported by NVM Express.
04	RO	0	Memory Write and Invalidate Enable (MWIE): Not supported by NVM Express.
03	RO	0	Special Cycle Enable (SCE): Not supported by NVM Express.
02	RW	0	Bus Master Enable (BME): Enables the controller to act as a master for data transfers. When set to '1', bus master activity is allowed. When cleared to '0', the controller stops any active DMA engines and returns to an idle condition.
01	RW	0	Memory Space Enable (MSE): Controls access to the controller's register memory space.
00	RW	0	I/O Space Enable (IOSE): Controls access to the controller's target I/O space.

2.1.3 Offset 06h: STS - Device Status

Bit	Type	Reset	Description
15	RWC	0	Detected Parity Error (DPE): Set to '1' by hardware when the controller detects a parity error on its interface.
14	RO	0	Signaled System Error (SSE): Not supported by NVM Express.
13	RWC	0	Received Master-Abort (RMA): Set to '1' by hardware when the controller receives a master abort to a cycle it generated.
12	RWC	0	Received Target Abort (RTA): Set to '1' by hardware when the controller receives a target abort to a cycle it generated.
11	RO	0	Signaled Target-Abort (STA): Not supported by NVM Express.
10:09	RO	Impl Spec	DEVSEL# Timing (DEVT): Controls the device select time for the controller's PCI interface. This field is not applicable to PCI Express implementations.
08	RWC	0	Master Data Parity Error Detected (DPD): Set to '1' by hardware when the controller, as a master, either detects a parity error or sees the parity error line asserted, and the parity error response bit (CMD.PEE) is set to '1'.
07	RO	Impl Spec	Fast Back-to-Back Capable (FBC): Indicates whether the controller accepts fast back-to-back cycles. This field is not applicable to PCI Express implementations.
06	RO	0	Reserved
05	RO	Impl Spec	66 MHz Capable (C66): Indicates whether the controller may operate at 66 MHz. This field is not applicable to PCI Express implementations.
04	RO	1	Capabilities List (CL): Indicates the presence of a capabilities list. The controller shall support the PCI Power Management capability as a minimum.
03	RO	0	Interrupt Status (IS): Indicates the interrupt status of the device ('1' = asserted).
02:00	RO	0	Reserved

2.1.4 Offset 08h: RID - Revision ID

Bits	Type	Reset	Description
07:00	RO	Impl Spec	Revision ID (RID): Indicates stepping of the controller hardware.

2.1.5 Offset 09h: CC - Class Code

Bits	Type	Reset	Description
23:16	RO	01h	Base Class Code (BCC): Indicates the base class code as a mass storage controller.
15:08	RO	08h	Sub Class Code (SCC): Indicates the sub class code as a Non-Volatile Memory controller.
07:00	RO	02h	Programming Interface (PI): This field specifies the programming interface of the controller is NVM Express. (Note: The PCI SIG documentation refers to this as Enterprise NVMHCI.)

2.1.6 Offset 0Ch: CLS – Cache Line Size

Bits	Type	Reset	Description
07:00	RO	00h	Cache Line Size (CLS): Not supported by NVM Express.

2.1.7 Offset 0Dh: MLT – Master Latency Timer

Bits	Type	Reset	Description
07:00	RO	00h	Master Latency Timer (MLT): Indicates the number of clocks the controller is allowed to act as a master on PCI. For a PCI Express device, this register does not apply and shall be hardwired to '0'.

2.1.8 Offset 0Eh: HTYPE – Header Type

Bits	Type	Reset	Description
07	RO	Impl Spec	Multi-Function Device (MFD): Indicates whether the controller is part of a multi-function device.
06:00	RO	00h	Header Layout (HL): Indicates that the controller uses a target device layout.

2.1.9 Offset 0Fh: BIST – Built In Self Test (Optional)

The following register is optional, but if implemented, shall look as follows. When not implemented, it shall be read-only 00h.

Bits	Type	Reset	Description
07	RO	Impl Spec	BIST Capable (BC): Indicates whether the controller has a BIST function.
06	RW	0	Start BIST (SB): Host software sets this bit to '1' to invoke BIST. The controller clears this bit to '0' when BIST is complete.
05:04	RO	00	Reserved
03:00	RO	0h	Completion Code (CC): Indicates the completion code status of BIST. A non-zero value indicates a failure.

2.1.10 Offset 10h: MLBAR (BAR0) – Memory Register Base Address, lower 32-bits

This register allocates space for the memory registers defined in section 3.

Bit	Type	Reset	Description
31:14	RW	0	Base Address (BA): Base address of register memory space. For controllers that support a larger number of doorbell registers or have vendor specific space following the doorbell registers, more bits are allowed to be RO such that more memory space is consumed.
13:04	RO	0	Reserved
03	RO	0	Prefetchable (PF): Indicates that this range is not pre-fetchable
02:01	RO	10	Type (TP): Indicates that this range may be mapped anywhere in 64-bit address space and that the register is 64-bits wide.
00	RO	0	Resource Type Indicator (RTE): Indicates a request for register memory space.

2.1.11 Offset 14h: MUBAR (BAR1) – Memory Register Base Address, upper 32-bits

This register specifies the upper 32-bit address of the memory registers defined in section 3.

Bit	Type	Reset	Description
31:00	RW	0	Base Address (BA): Upper 32-bits (bits 63:32) of the memory register base address.

NOTE: NVM Express implementations that reside behind PCI compliant bridges, such as PCI Express Endpoints, are restricted to having 32-bit assigned base address registers due to limitations on the maximum address that may be specified in the bridge for non-prefetchable memory. See the PCI Bridge 1.2 specification for more information on this restriction.

2.1.12 Offset 18h: IDBAR (BAR2) – Index/Data Pair Register Base Address (Optional)

This register specifies the Index/Data Pair base address. These registers are used to access the memory registers defined in section 3 using I/O based accesses. If Index/Data Pair is not supported, then the IDBAR shall be read only 0h.

Bit	Type	Reset	Description
31:03	RW	0	Base Address (BA): Base address of Index/Data Pair registers that is 8 bytes in size.
02:01	RO	0	Reserved
00	RO	1	Resource Type Indicator (RTE): Indicates a request for register I/O space.

2.1.13 Offset 1Ch – 20h: BAR3 –Reserved

The BAR3 register allocates memory or an I/O space. BAR3 is reserved for future use.

2.1.14 Offset 20h – 23h: BAR4 – Vendor Specific

The BAR4 register is vendor specific. Vendor specific space may also be allocated at the end of the memory registers defined in section 3.

2.1.15 Offset 24h – 27h: BAR5 – Vendor Specific

The BAR5 register is vendor specific. Vendor specific space may also be allocated at the end of the memory registers defined in section 3.

2.1.16 Offset 28h: CCPTR – CardBus CIS Pointer

Bit	Type	Reset	Description
31:00	RO	0	Not supported by NVM Express.

2.1.17 Offset 2Ch: SS - Sub System Identifiers

Bits	Type	Reset	Description
31:16	RO	HwInit	Subsystem ID (SSID): Indicates the sub-system identifier.
15:00	RO	HwInit	Subsystem Vendor ID (SSVID): Indicates the sub-system vendor identifier

2.1.18 Offset 30h: EROM – Expansion ROM (Optional)

If the register is not implemented, it shall be read-only 00h.

Bit	Type	Reset	Description
31:00	RW	Impl Spec	ROM Base Address (RBA): Indicates the base address of the controller's expansion ROM. Not supported for integrated implementations.

2.1.19 Offset 34h: CAP – Capabilities Pointer

Bit	Type	Reset	Description
7:0	RO	PMCAP	Capability Pointer (CP): Indicates the first capability pointer offset. It points to the PCI Power Management capability offset.

2.1.20 Offset 3Ch: INTR - Interrupt Information

Bits	Type	Reset	Description
15:08	RO	Impl Spec	Interrupt Pin (IPIN): This indicates the interrupt pin the controller uses.
07:00	RW	00h	Interrupt Line (ILINE): Host software written value to indicate which interrupt line (vector) the interrupt is connected to. No hardware action is taken on this register.

2.1.21 Offset 3Eh: MGNT – Minimum Grant

Bits	Type	Reset	Description
07:00	RO	00h	Grant (GNT): Not supported by NVM Express.

2.1.22 Offset 3Fh: MLAT – Maximum Latency

Bits	Type	Reset	Description
07:00	RO	00h	Latency (LAT): Not supported by NVM Express.

2.2 PCI Power Management Capabilities

See section 3.1.5 for requirements when the PCI power management state changes.

Start (hex)	End (hex)	Symbol	Name
PMCAP	PMCAP+1	PID	PCI Power Management Capability ID
PMCAP+2	PMCAP+3	PC	PCI Power Management Capabilities
PMCAP+4	PMCAP+5	PMCS	PCI Power Management Control and Status

2.2.1 Offset PMCAP: PID - PCI Power Management Capability ID

Bit	Type	Reset	Description
15:08	RO	Impl Spec	Next Capability (NEXT): Indicates the location of the next capability item in the list. This may be other capability pointers (such as Message Signaled Interrupts) or it may be the last item in the list.
07:00	RO	01h	Cap ID (CID): Indicates that this pointer is a PCI Power Management capability.

2.2.2 Offset PMCAP + 2h: PC – PCI Power Management Capabilities

Bit	Type	Reset	Description
15:11	RO	0h	PME_Support (PSUP): Not supported by NVM Express.
10	RO	0	D2_Support (D2S): Indicates support for the D2 power management state. Not recommended for implementation.
09	RO	0	D1_Support (D1S): Indicates support for the D1 power management state. Not recommended for implementation.
08:06	RO	000	Aux_Current (AUXC): Not supported by NVM Express.
05	RO	Impl Spec	Device Specific Initialization (DSI): Indicates whether device specific initialization is required.
04	RO	0	Reserved
03	RO	0	PME_Clock (PMEC): Indicates that PCI clock is not required to generate PME#.
02:00	RO	Impl Spec	Version (VS): Indicates support for revision 1.2 or higher revisions of the PCI Power Management Specification.

2.2.3 Offset PMCAP + 4h: PMCS – PCI Power Management Control and Status

Bit	Type	Reset	Description
15	RO	0	PME Status (PMES): Not supported by NVM Express.
14:13	RO	0	Data Scale (DSC): Not supported by NVM Express.
12:09	RO	0	Data Select (DSE): Not supported by NVM Express.
08	RO	0	PME Enable (PMEE): Not supported by NVM Express.
07:04	RO	0	Reserved
03	RO	1	No Soft Reset (NSFRST): A value of '1' indicates that the controller transitioning from D3hot to D0 because of a power state command does not perform an internal reset.
02	RO	0	Reserved
01:00	R/W	00	<p>Power State (PS): This field is used both to determine the current power state of the controller and to set a new power state. The values are:</p> <p>00 – D0 state 01 – D1 state 10 – D2 state 11 – D3_{HOT} state</p> <p>When in the D3_{HOT} state, the controller's configuration space is available, but the register I/O and memory spaces are not. Additionally, interrupts are blocked.</p>

2.3 Message Signaled Interrupt Capability (Optional)

Start (hex)	End (hex)	Symbol	Name
MSICAP	MSICAP+1	MID	Message Signaled Interrupt Capability ID
MSICAP+2	MSICAP+3	MC	Message Signaled Interrupt Message Control
MSICAP+4	MSICAP+7	MA	Message Signaled Interrupt Message Address
MSICAP+8	MSICAP+B	MUA	Message Signaled Interrupt Upper Address
MSICAP+C	MSICAP+D	MD	Message Signaled Interrupt Message Data
MSICAP+10h	MSICAP+13h	MMASK	Message Signaled Interrupt Mask Bits (Optional)
MSICAP+14h	MSICAP+17h	MPEND	Message Signaled Interrupt Pending Bits (Optional)

2.3.1 Offset MSICAP: MID – Message Signaled Interrupt Identifiers

Bits	Type	Reset	Description
15:08	RO	Impl Spec	Next Pointer (NEXT): Indicates the next item in the list. This may be other capability pointers or it may be the last item in the list.
07:00	RO	05h	Capability ID (CID): Capabilities ID indicates this is a Message Signaled Interrupt (MSI) capability.

2.3.2 Offset MSICAP + 2h: MC – Message Signaled Interrupt Message Control

Bits	Type	Reset	Description
15:09	RO	0	Reserved
08	RO	0	Per-Vector Masking Capable (PVM): Specifies whether controller supports MSI per-vector masking.
07	RO	1	64 Bit Address Capable (C64): Specifies whether the controller is capable of generating 64-bit messages. NVM Express controllers shall be 64-bit capable.
06:04	RW	000	Multiple Message Enable (MME): Indicates the number of messages the controller should assert. Controllers that only support single message MSI may implement this field as read-only.
03:01	RO	Impl Spec	Multiple Message Capable (MMC): Indicates the number of messages the controller wants to assert.
00	RW	0	MSI Enable (MSIE): If set to '1', MSI is enabled and the traditional interrupt pins are not used to generate interrupts. If cleared to '0', MSI operation is disabled and the traditional interrupt pins are used.

2.3.3 Offset MSICAP + 4h: MA – Message Signaled Interrupt Message Address

Bits	Type	Reset	Description
31:02	RW	0	Address (ADDR): Lower 32 bits of the system specified message address, always Dword aligned.
01:00	RO	00	Reserved

2.3.4 Offset MSICAP + 8h: MUA – Message Signaled Interrupt Upper Address

Bits	Type	Reset	Description
31:00	RW	0	Upper Address (UADDR): Upper 32 bits of the system specified message address. This register is required when the MSI Capability is supported by the controller.

2.3.5 Offset MSICAP + Ch: MD – Message Signaled Interrupt Message Data

Bits	Type	Reset	Description
15:00	RW	0	Data (DATA): This 16-bit field is programmed by system software if MSI is enabled. Its content is driven onto the lower word (PCI AD[15:0]) during the data phase of the MSI memory write transaction.

2.3.6 Offset MSICAP + 10h: MMASK – Message Signaled Interrupt Mask Bits (Optional)

Bits	Type	Reset	Description
31:00	RW	0	Mask Bits (MASK): For each Mask bit that is set to '1', the function is prohibited from sending the associated message.

2.3.7 Offset MSICAP + 14h: MPEND – Message Signaled Interrupt Pending Bits (Optional)

Bits	Type	Reset	Description
31:00	RW	0	Pending Bits (PEND): For each Pending bit that is set to '1', the function has a pending associated message.

2.4 MSI-X Capability (Optional)

Start (hex)	End (hex)	Symbol	Name
MSIXCAP	MSIXCAP+1	MXID	MSI-X Capability ID
MSIXCAP+2	MSIXCAP+3	MXC	MSI-X Message Control
MSIXCAP+4	MSIXCAP+7	MTAB	MSI-X Table Offset and Table BIR
MSIXCAP+8	MSIXCAP+B	MPBA	MSI-X PBA Offset and PBA BIR

Note: It is recommended that the controller allocate a unique MSI-X vector for each Completion Queue.

The Table BIR and PBA BIR data structures may be allocated in either BAR0-1 or BAR4-5 in implementations. These tables should be 4KB aligned. The memory page(s) that comprise the Table BIR and PBA BIR shall not include other registers/structures. It is recommended that these structures be allocated in BAR0-1 following the Submission Queue and Completion Queue Doorbell registers. Refer to the PCI reference for more information on allocation requirements for these data structures.

2.4.1 Offset MSIXCAP: MXID – MSI-X Identifiers

Bits	Type	Reset	Description
15:08	RO	Impl Spec	Next Pointer (NEXT): Indicates the next item in the list. This may be other capability pointers or it may be the last item in the list.
07:00	RO	11h	Capability ID (CID): Capabilities ID indicates this is an MSI-X capability.

2.4.2 Offset MSIXCAP + 2h: MXC – MSI-X Message Control

Bits	Type	Reset	Description
15	RW	0	MSI-X Enable (MXE): If set to '1' and the MSI Enable bit in the MSI Message Control register is cleared to '0', the function is permitted to use MSI-X to request service and is prohibited from using its INTx# pin (if implemented). If cleared to '0', the function is prohibited from using MSI-X to request service.
14	RW	0	Function Mask (FM): If set to '1', all of the vectors associated with the function are masked, regardless of their per vector Mask bit states. If cleared to '0', each vector's Mask bit determines whether the vector is masked or not. Setting or clearing the MSI-X Function Mask bit has no effect on the state of the per vector Mask bits.
13:11	RO	0h	Reserved
10:00	RO	Impl Spec	Table Size (TS): This value indicates the size of the MSI-X Table as the value n , which is encoded as $n - 1$. For example, a returned value of 3h corresponds to a table size of 4.

2.4.3 Offset MSIXCAP + 4h: MTAB – MSI-X Table Offset / Table BIR

Bits	Type	Reset	Description																		
31:03	RO	Impl Spec	Table Offset (TO): Used as an offset from the address contained by one of the function's Base Address registers to point to the base of the MSI-X Table. The lower three Table BIR bits are masked off (cleared to 000b) by system software to form a 32-bit Qword-aligned offset.																		
02:00	RO	Impl Spec	<p>Table BIR (TBIR): This field indicates which one of a function's Base Address registers, located beginning at 10h in Configuration Space, is used to map the function's MSI-X Table into system memory.</p> <table border="1" data-bbox="701 913 1203 1173"> <thead> <tr> <th>BIR Value</th> <th>BAR Offset</th> </tr> </thead> <tbody> <tr> <td>0</td> <td>10h</td> </tr> <tr> <td>1</td> <td>na</td> </tr> <tr> <td>2</td> <td>na</td> </tr> <tr> <td>3</td> <td>Reserved</td> </tr> <tr> <td>4</td> <td>20h</td> </tr> <tr> <td>5</td> <td>24h</td> </tr> <tr> <td>6</td> <td>Reserved</td> </tr> <tr> <td>7</td> <td>Reserved</td> </tr> </tbody> </table> <p>For a 64-bit Base Address register, the Table BIR indicates the lower Dword. With PCI-to-PCI bridges, BIR values 2 through 5 are also reserved.</p>	BIR Value	BAR Offset	0	10h	1	na	2	na	3	Reserved	4	20h	5	24h	6	Reserved	7	Reserved
BIR Value	BAR Offset																				
0	10h																				
1	na																				
2	na																				
3	Reserved																				
4	20h																				
5	24h																				
6	Reserved																				
7	Reserved																				

2.4.4 Offset MSIXCAP + 8h: MPBA – MSI-X PBA Offset / PBA BIR

Bits	Type	Reset	Description																		
31:03	RO	Impl Spec	PBA Offset (PBAO): Used as an offset from the address contained by one of the function's Base Address registers to point to the base of the MSI-X PBA. The lower three PBA BIR bits are masked off (cleared to 000b) by software to form a 32-bit Qword-aligned offset.																		
02:00	RO	Impl Spec	<p>PBA BIR (PBIR): This field indicates which one of a function's Base Address registers, located beginning at 10h in Configuration Space, is used to map the function's MSI-X PBA into system memory.</p> <table border="1" data-bbox="701 1570 1203 1831"> <thead> <tr> <th>BIR Value</th> <th>BAR Offset</th> </tr> </thead> <tbody> <tr> <td>0</td> <td>10h</td> </tr> <tr> <td>1</td> <td>na</td> </tr> <tr> <td>2</td> <td>na</td> </tr> <tr> <td>3</td> <td>Reserved</td> </tr> <tr> <td>4</td> <td>20h</td> </tr> <tr> <td>5</td> <td>24h</td> </tr> <tr> <td>6</td> <td>Reserved</td> </tr> <tr> <td>7</td> <td>Reserved</td> </tr> </tbody> </table>	BIR Value	BAR Offset	0	10h	1	na	2	na	3	Reserved	4	20h	5	24h	6	Reserved	7	Reserved
BIR Value	BAR Offset																				
0	10h																				
1	na																				
2	na																				
3	Reserved																				
4	20h																				
5	24h																				
6	Reserved																				
7	Reserved																				

2.5 PCI Express Capability (Optional)

The PCI Express Capability definitions below are based on the PCI Express 2.1 Base specification. Implementations may choose to base the device on a specification beyond the PCI Express 2.1 Base specification. In all cases, the PCI Express Base specification is the normative reference for the PCI Express Capability registers.

Note: TLP poisoning is a mandatory capability for PCI Express implementations. There are optional features of TLP poisoning, such as TLP poisoning for a transmitter. When an NVM Express device has an error on a transmission to the host (e.g., error for a Read command), the error should be indicated as part of the NVM Express command status and not via TLP poisoning.

Start (hex)	End (hex)	Symbol	Name
PXCAP	PXCAP+1	PXID	PCI Express Capability ID
PXCAP+2	PXCAP+3	PXCAP	PCI Express Capabilities
PXCAP+4	PXCAP+7	PXDCAP	PCI Express Device Capabilities
PXCAP+8	PXCAP+9	PXDC	PCI Express Device Control
PXCAP+A	PXCAP+B	PXDS	PCI Express Device Status
PXCAP+C	PXCAP+F	PXLCAP	PCI Express Link Capabilities
PXCAP+10h	PXCAP+11h	PXLC	PCI Express Link Control
PXCAP+12h	PXCAP+13h	PXLS	PCI Express Link Status
PXCAP+24h	PXCAP+27h	PXDCAP2	PCI Express Device Capabilities 2
PXCAP+28h	PXCAP+29h	PXDC2	PCI Express Device Control 2

2.5.1 Offset PXCAP: PXID – PCI Express Capability ID

Bits	Type	Reset	Description
15:8	RO	Impl Spec	Next Pointer (NEXT): Indicates the next item in the list. This may be other capability pointers or it may be the last item in the list.
7:0	RO	10h	Capability ID (CID): Indicates that this capability structure is a PCI Express capability.

2.5.2 Offset PXCAP + 2h: PXCAP – PCI Express Capabilities

Bits	Type	Reset	Description
15:14	RO	00b	Reserved
13:9	RO	Impl Spec	Interrupt Message Number (IMN): This field indicates the MSI/MSI-X vector that is used for the interrupt message generated in association with any of the status bits of this Capability structure. There are no status bits that generate interrupts defined in this capability within this specification, thus this field is not used.
8	RO	0h	Slot Implemented (SI): Not applicable for PCIe Express Endpoint devices.
7:4	RO	0h	Device/Port Type (DPT): Indicates the specific type of this PCI Express function. This device shall be indicated as a PCI Express Endpoint.
3:0	RO	2h	Capability Version (VER): Indicates that this capability structure is a PCI Express capability structure.

2.5.3 Offset PXCAP + 4h: PXDCAP – PCI Express Device Capabilities

Bits	Type	Reset	Description
31:29	RO	000b	Reserved
28	RO	1b	Function Level Reset Capability (FLRC): A value of '1' indicates the Function supports the optional Function Level Reset mechanism. NVM Express devices shall support Function Level Reset.
27:26	RO	00b	Captured Slot Power Limit Scale (CSPLS): Specifies the scale used for the Slot Power Limit Value.
25:18	RO	0h	Captured Slot Power Limit Value (CSPLV): In combination with the Slot Power Limit Scale value, specifies the upper limit on power supplied by the slot. Power limit (in Watts) is calculated by multiplying the value in this field by the value in the Slot Power Limit Scale field.
17:16	RO	00b	Reserved
15	RO	1b	Role-based Error Reporting (RER): When set to '1', indicates that the Function implements role-based error reporting. This functionality is required.
14:12	RO	000b	Reserved

11:9	RO	Impl Spec	Endpoint L1 Acceptable Latency (L1L): This field indicates the acceptable latency that the Endpoint is able to withstand due to a transition from the L1 state to the L0 state.
08:06	RO	Impl Spec	Endpoint L0s Acceptable Latency (L0SL): This field indicates the acceptable total latency that the Endpoint is able to withstand due to the transition from L0s state to the L0 state.
05	RO	Impl Spec	Extended Tag Field Supported (ETFS): This field indicates the maximum supported size of the Tag field as a Requester.
04:03	RO	Impl Spec	Phantom Functions Supported (PFS): This field indicates the support for use of unclaimed Function Numbers to extend the number of outstanding transactions allowed by logically combining unclaimed Function Numbers with the Tag identifier.
02:00	RO	Impl Spec	Max Payload Size Supported (MPS): This field indicates the maximum payload size that the function may support for TLPs.

2.5.4 Offset PXCAP + 8h: PXDC – PCI Express Device Control

Bits	Type	Reset	Description
15	R/W	0b	Initiate Function Level Reset – A write of ‘1’ initiates Function Level Reset to the Function. The value read by software from this bit shall always ‘0’.
14:12	R/W/ RO	Impl Spec	Max_Read_Request_Size (MRRS): This field sets the maximum Read Request size for the Function as a Requester. The Function shall not generate Read Requests with size exceeding the set value.
11	R/W/ RO	0	Enable No Snoop (ENS): If this field is set to ‘1’, the Function is permitted to set the No Snoop bit in the Requestor Attributes of transactions it initiates that do not require hardware enforced cache coherency. This field may be hardwired to ‘0’ if a Function would never set the No Snoop attribute in transactions it initiates.
10	R/W/ RO	0	AUX Power PM Enable (APPME): If this field is set to ‘1’, enables a Function to draw AUX power independent of PME AUX power. Functions that do not implement this capability hardware this bit to 0b.
09	R/W/ RO	0	Phantom Functions Enable (PFE): If this field is set to ‘1’, enables a Function to use unclaimed Functions as Phantom Functions to extend the number of outstanding transaction identifiers. If this field is cleared to ‘0’, the Function is not allowed to use Phantom Functions.
08	R/W/ RO	0	Extended Tag Enable (ETE): If this field is set to ‘1’, enables a Function to use an 8-bit Tag field as a Requester. If this field is cleared to ‘0’, the Function is restricted to a 5-bit Tag field.
07:05	R/W/ RO	000b	Max Payload Size (MPS): This field sets the maximum TLP payload size for the Function. As a receiver, the Function shall handle TLPs as large as the set value. As a transmitter, the Function shall not generate TLPs exceeding the set value. Functions that support only the 128 byte max payload size are permitted to hardwire this field to 0h.
04	R/W/ RO	Impl Spec	Enable Relaxed Ordering (ERO): If this field is set to ‘1’, the Function is permitted to set the Relaxed Ordering bit in the Attributes field of transactions it initiates that do not require strong write ordering.
03	R/W	0	Unsupported Request Reporting Enable (URRE): This bit, in conjunction with other bits, controls the signaling of Unsupported Requests by sending error messages.
02	R/W	0	Fatal Error Reporting Enable (FERE): This bit, in conjunction with other bits, controls the signaling of Unsupported Requests by sending ERR_FATAL messages.
01	R/W	0	Non-Fatal Error Reporting Enable (NFERE): This bit, in conjunction with other bits, controls the signaling of Unsupported Requests by sending ERR_NONFATAL messages.
00	R/W	0	Correctable Error Reporting Enable (CERE): This bit, in conjunction with other bits, controls the signaling of Unsupported Requests by sending ERR_COR messages.

2.5.5 Offset PXCAP + Ah: PXDS – PCI Express Device Status

Bits	Type	Reset	Description
15:06	RO	0h	Reserved
05	RO	0	Transactions Pending (TP): When set to '1' this bit indicates that the Function has issued non-posted requests that have not been completed. This bit is cleared to '0' only when all outstanding non-posted requests have completed or have been terminated by the completion timeout mechanism. This bit shall also be cleared to '0' upon completion of a Function Level Reset.
04	RO	Impl Spec	AUX Power Detected (APD): Functions that require AUX power report this field as set to '1' if AUX power is detected by the Function.
03	RWC	0	Unsupported Request Detected (URD): When set to '1' this bit indicates that the function received an Unsupported Request. Errors are logged in this register regardless of whether error reporting is enabled in the Device Control register.
02	RWC	0	Fatal Error Detected (FED): When set to '1' this bit indicates that the status of fatal errors detected. Errors are logged in this register regardless of whether error reporting is enabled in the Device Control register.
01	RWC	0	Non-Fatal Error Detected (NFED): When set to '1' this bit indicates that the status of non-fatal errors detected. Errors are logged in this register regardless of whether error reporting is enabled in the Device Control register.
00	RWC	0	Correctable Error Detected (CED): When set to '1' this bit indicates status of correctable errors detected. Errors are logged in this register regardless of whether error reporting is enabled in the Device Control register.

2.5.6 Offset PXCAP + Ch: PXLCAP – PCI Express Link Capabilities

Bits	Type	Reset	Description
31:24	RO	Hwlnit	Port Number (PN): This field indicates the PCI Express port number for this device.
23:22	RO	0h	Reserved
21	RO	0	Link Bandwidth Notification Capability (LBNC): Not applicable to Endpoints.
20	RO	0	Data Link Layer Link Active Reporting Capable (DLLLA): Not applicable to Endpoints.
19	RO	0	Surprise Down Error Reporting Capable (SDERC): Not applicable to Endpoints.
18	RO	Impl Spec	Clock Power Management (CPM): If this field is set to '1', the component tolerates the removal of any reference clock(s) via the "clock request" (CLKREQ#) mechanism when the Link is in the L1 and L2/L3 Ready Link states. If this field is cleared to '0', the component does not have this capability and that reference clock(s) shall not be removed in these Link states.
17:15	RO	Impl Spec	L1 Exit Latency (L1EL): This field indicates the L1 exit latency for the given PCI Express Link. The value reported indicates the length of time this port requires to complete transition from L1 to L0.
14:12	RO	Impl Spec	L0s Exit Latency (L0SEL): This field indicates the L0s exit latency for the given PCI Express Link. The value reported indicates the length of time this port requires to complete transition from L0s to L0.
11:10	RO	Impl Spec	Active State Power Management Support (ASPMS): This field indicates the level of ASPM supported on the given PCI Express Link.
09:04	RO	Impl Spec	Maximum Link Width (MLW): This field indicates the maximum Link width (xn – corresponding to n lanes) implemented by the component.
03:00	RO	Impl Spec	Supported Link Speeds (SLS): This field indicates the supported Link speed(s) of the associated port.

2.5.7 Offset PXCAP + 10h: PXLC – PCI Express Link Control

Bits	Type	Reset	Description
15:10	RO	0h	Reserved
09	RW/ RO	0h	Hardware Autonomous Width Disable (HAWD): When set to '1', disables hardware from changing the Link width for reasons other than attempting to correct unreliable Link operation by reducing Link width. Components that do not implement the ability autonomously to change Link width are permitted to hardwire this bit to '0'.
08	RW	0	Enable Clock Power Management (ECPM): When cleared to '0', clock power management is disabled and the device shall hold the CLKREQ# signal low. When set to '1', the device is permitted to use the CLKREQ# signal to power manage the Link clock according to the protocol defined for mini PCI Express.
07	RW	0	Extended Synch (ES): When set to '1', this bit forces the transmission of additional Ordered Sets when exiting the L0s state and when in the Recovery state. This mode provides external devices (e.g. logic analyzers) monitoring the Link time to achieve bit and symbol lock before the Link enters the L0 state and resumes communication.
06	RW	0	Common Clock Configuration (CCC): When set to '1', this bit indicates that this component and the component at the opposite end of this Link are operating with a distributed common reference clock. When cleared to '0' this component and the component at the opposite end of this Link are operating with asynchronous reference clocks.
05:04	RO	0h	Reserved: These bits are reserved on Endpoints.
03	RW	0	Read Completion Boundary (RCB): Indicate the RCB value of the root port.
02	RO	0	Reserved
01:00	RW	0h	Active State Power Management Control (ASPMC): This field controls the level of ASPM executed on the PCI Express Link.

2.5.8 Offset PXCAP + 12h: PXLS – PCI Express Link Status

Bits	Type	Reset	Description
15:13	RO	0h	Reserved
12	RO	Impl Spec	Slot Clock Configuration: If this bit is set to '1', it indicates that the component uses the same physical reference clock that the platform provides on the connector. If the device uses an independent clock irrespective of a reference on the connector, this bit shall be cleared to '0'.
11:10	RO	0h	Reserved
09:04	RO	na	Negotiated Link Width (NLW): This field indicates the negotiated Link width. This field is undefined when the Link is not up.
03:00	RO	na	Current Link Speed (CLS): This field indicates the negotiated Link speed. This field is undefined when the Link is not up.

2.5.9 Offset PXCAP + 24h: PXDCAP2 – PCI Express Device Capabilities 2

Bits	Type	Reset	Description
31:24	RO	0h	Reserved
23:22	RO	Impl Spec	Max End-End TLP Prefixes (MEETP): Indicates the maximum number of End-End TLP Prefixes supported by this Function. TLPs received by this Function that contain more End-End TLP Prefixes than are supported shall be handled as Malformed TLPs.
21	RO	Impl Spec	End-End TLP Prefix Supported (EETPS): Indicates whether End-End TLP Prefix support is offered by a Function. If cleared to '0', there is no support. If set to '1', the Function supports receiving TLPs containing End-End TLP Prefixes.
20	RO	Impl Spec	Extended Fmt Field Supported (EFFS): If set to '1', the Function supports the 3-bit definition of the Fmt field. If cleared to '0', the Function supports a 2-bit definition of the Fmt field.
19:18	RO	Impl Spec	OBFF Supported (OBFFS): This field indicates the level of support for OBFF.
17:14	RO	0h	Reserved
13:12	RO	Impl Spec	TPH Completer Supported (TPHCS): Defined encodings are listed in the following table.

			Value		Definition
			Value	Definition	
			00b	TPH and Extended TPH Completer not supported	
			01b	TPH Completer supported; Extended TPH Completer not supported	
			10b	Reserved	
			11b	Both TPH and Extended TPH Completer supported	
11	RO	Impl Spec	Latency Tolerance Reporting Supported (LTRS): If set to '1', then the latency tolerance reporting mechanism is supported.		
10	RO	0	No RO-enabled PR-PR Passing (NPRPR): Not applicable to NVM Express.		
09	RO	Impl Spec	128-bit CAS Completer Supported (128CCS): This bit shall be set to '1' if the Function supports this optional capability.		
08	RO	Impl Spec	64-bit AtomicOp Completer Supported (64AOCs): Includes FetchAdd, Swap, and CAS AtomicOps. This bit shall be set to '1' if the Function supports this optional capability.		
07	RO	Impl Spec	32-bit AtomicOp Completer Supported (32AOCs): Includes FetchAdd, Swap, and CAS AtomicOps. This bit shall be set to '1' if the Function supports this optional capability.		
06	RO	0	AtomicOp Routing Supported (AORS): Not applicable to NVM Express.		
05	RO	0	ARI Forwarding Supported (ARIFS): Not applicable for NVM Express.		
04	RO	1	Completion Timeout Disable Supported (CTDS): A value of '1' indicates support for the Completion Timeout Disable mechanism. The Completion Timeout Disable mechanism is required for Endpoints that issue requests on their own behalf.		
03:00	RO	Impl Spec	Completion Timeout Ranges Supported (CTRS): This field indicates device function support for the optional Completion Timeout programmability mechanism.		

2.5.10 Offset PXCAP + 28h: PXDC2 – PCI Express Device Control 2

Bits	Type	Reset	Description
31:15	RO	0h	Reserved
14:13	RW	Impl Spec	OBFF Enable (OBFFE): This field controls the capabilities enabled for OBFF.
12:11	RO	00b	Reserved
10	RW	0	Latency Tolerance Reporting Mechanism Enable (LTRME): When set to '1', enables the LTR mechanism. When cleared to '0', the LTR mechanism is disabled.
09:05	RO	0h	Reserved
04	RW	0	Completion Timeout Disable (CTD): When set to '1', this bit disables the Completion Timeout mechanism.
03:00	RW/RO	Impl Spec	Completion Timeout Value: Specifies the completion timeout value. If this feature is not supported in PXDCAP2, then this field is read only 0h.

2.6 Advanced Error Reporting Capability (Optional)

The Advanced Error Reporting definitions below are based on the PCI Express 2.1 Base specification. Implementations may choose to base the device on a specification beyond the PCI Express 2.1 Base specification. In all cases, the PCI Express Base specification is the normative reference for the Advanced Error Reporting registers.

Start (hex)	End (hex)	Symbol	Name
AERCAP	AERCAP+3	AERID	AER Capability ID
AERCAP+4	AERCAP+7	AERUCES	AER Uncorrectable Error Status Register
AERCAP+8	AERCAP+B	AERUCEM	AER Uncorrectable Error Mask Register
AERCAP+C	AERCAP+F	AERUCESEV	AER Uncorrectable Error Severity Register
AERCAP+10h	AERCAP+13h	AERCES	AER Correctable Error Status Register
AERCAP+14h	AERCAP+17h	AERCEM	AER Correctable Error Mask Register
AERCAP+18h	AERCAP+1Bh	AERCC	AER Advanced Error Capabilities and Control Reg.
AERCAP+1Ch	AERCAP+2Bh	AERHL	AER Header Log Register
AERCAP+38h	AERCAP+47h	AERTLP	AER TLP Prefix Log Register (Optional)

2.6.1 Offset AERCAP: AERID – AER Capability ID

Bits	Type	Reset	Description
31:20	RO	Impl Spec	Next Pointer (NEXT): Indicates the next item in the list. This may be other capability pointers or it may be the last item in the list.
19:16	RO	2h	Capability Version (CVER): Indicates the version of the capability structure.
15:0	RO	0001h	Capability ID (CID): Indicates that this capability structure is an Advanced Error Reporting capability.

2.6.2 Offset AERCAP + 4: AERUCES – AER Uncorrectable Error Status Register

This register indicates the error detection status of the individual errors on the controller. These bits are sticky – they are neither initialized nor modified during a hot reset or FLR.

Bits	Type	Reset	Description
31:26	RO	0	Reserved
25	RWC/RO	0	TLP Prefix Blocked Error Status (TPBES) (Optional)
24	RWC/RO	0	AtomicOp Egress Blocked Status (AOEBS) (Optional)
23	RWC/RO	0	MC Blocked TLP Status (MCBTS) (Optional)
22	RWC/RO	0	Uncorrectable Internal Error Status (UIES) (Optional)
21	RWC/RO	0	ACS Violation Status (ACSVS) (Optional)
20	RWC	0	Unsupported Request Error Status (URES)
19	RWC/RO	0	ECRC Error Status (ECRCES) (Optional)
18	RWC	0	Malformed TLP Status (MTS)
17	RWC/RO	0	Receiver Overflow Status (ROS) (Optional)
16	RWC	0	Unexpected Completion Status (UCS)
15	RWC/RO	0	Completer Abort Status (CAS) (Optional)
14	RWC	0	Completion Timeout Status (CTS)
13	RWC/RO	0	Flow Control Protocol Error Status (FCPES) (Optional)
12	RWC	0	Poisoned TLP Status (PTS)
11:05	RO	0	Reserved
04	RWC	0	Data Link Protocol Error Status (DLPES)
03:00	RO	0	Reserved

2.6.3 Offset AERCAP + 8: AERUCEM – AER Uncorrectable Error Mask Register

This register controls the reporting of the individual errors by the controller. A masked error is not reported in the in the Header Log register (AERHL), does not updated the First Error Pointer (AERCC.FEP), and is not reported to the host. These bits are sticky – they are neither initialized nor modified during a hot reset or FLR.

Bits	Type	Reset	Description
31:26	RO	0	Reserved
25	RW/RO	0	TLP Prefix Blocked Error Mask (TPBEM) (Optional)
24	RW/RO	0	AtomicOp Egress Blocked Mask (AOEBM) (Optional)
23	RW/RO	0	MC Blocked TLP Mask (MCBTM) (Optional)
22	RW/RO	1	Uncorrectable Internal Error Mask (UIEM) (Optional)
21	RW/RO	0	ACS Violation Mask (ACSVM) (Optional)
20	RW	0	Unsupported Request Error Mask (UREM)
19	RW/RO	0	ECRC Error Mask (ECRCM) (Optional)
18	RW	0	Malformed TLP Mask (MTM)
17	RW/RO	0	Receiver Overflow Mask (ROM) (Optional)
16	RW	0	Unexpected Completion Mask (UCM)
15	RW/RO	0	Completer Abort Mask (CAM) (Optional)
14	RW	0	Completion Timeout Mask (CTM)
13	RW/RO	0	Flow Control Protocol Error Mask (FCPEM) (Optional)

12	RW	0	Poisoned TLP Mask (PTM)
11:05	RO	0	Reserved
04	RW	0	Data Link Protocol Error Mask (DLPEM)
03:00	RO	0	Reserved

2.6.4 Offset AERCAP + Ch: AERUCSEV – AER Uncorrectable Error Severity Register

This register controls whether an individual error is reported as a non-fatal or a fatal error. An error is reported as fatal when the corresponding error bit in the severity register is set ('1'). If the bit is cleared ('0'), the corresponding error is considered non-fatal. These bits are sticky – they are neither initialized nor modified during a hot reset or FLR.

Bits	Type	Reset	Description
31:26	RO	0	Reserved
25	RW/RO	0	TLP Prefix Blocked Error Severity (TPBESEV) (Optional)
24	RW/RO	0	AtomicOp Egress Blocked Severity (AOEBSEV) (Optional)
23	RW/RO	0	MC Blocked TLP Severity (MCBTSEV) (Optional)
22	RW/RO	1	Uncorrectable Internal Error Severity (UIESEV) (Optional)
21	RW/RO	0	ACS Violation Severity (ACSVSEV) (Optional)
20	RW	0	Unsupported Request Error Severity (URESEV)
19	RW/RO	0	ECRC Error Severity (ECRCSEV) (Optional)
18	RW	1	Malformed TLP Severity (MTSEV)
17	RW/RO	1	Receiver Overflow Severity (ROSEV) (Optional)
16	RW	0	Unexpected Completion Severity (UCSEV)
15	RW/RO	0	Completer Abort Severity (CASEV) (Optional)
14	RW	0	Completion Timeout Severity (CTSEV)
13	RW/RO	1	Flow Control Protocol Error Severity (FCPESEV) (Optional)
12	RW	0	Poisoned TLP Severity (PTSEV)
11:05	RO	0	Reserved
04	RW	1	Data Link Protocol Error Severity (DLPESEV)
03:00	RO	0	Reserved

2.6.5 Offset AERCAP + 10h: AERCS – AER Correctable Error Status Register

This register reports error status of individual correctable error sources from the controller. These bits are sticky – they are neither initialized nor modified during a hot reset or FLR.

Bits	Type	Reset	Description
31:16	RO	0	Reserved
15	RWC/RO	0	Header Log Overflow Status (HLOS) (Optional)
14	RWC/RO	0	Corrected Internal Error Status (CIES) (Optional)
13	RWC	0	Advisory Non-Fatal Error Status (ANFES)
12	RWC	0	Replay Timer Timeout Status (RTS)
11:09	RO	0	Reserved
08	RWC	0	REPLAY_NUM Rollover Status (RRS)
07	RWC	0	Bad DLLP Status (BDS)
06	RWC	0	Bad TLP Status (BTS)
05:01	RO	0	Reserved
00	RWC	0	Receiver Error Status (RES)

2.6.6 Offset AERCAP + 14h: AERCCEM – AER Correctable Error Mask Register

This register controls the reporting of the individual correctable errors by the controller. A masked error is not reported to the host. These bits are sticky – they are neither initialized nor modified during a hot reset or FLR.

Bits	Type	Reset	Description
31:16	RO	0	Reserved
15	RW/RO	0	Header Log Overflow Mask (HLOM) (Optional)
14	RW/RO	0	Corrected Internal Error Mask (CIEM) (Optional)
13	RW	0	Advisory Non-Fatal Error Mask ANFEM)
12	RW	0	Replay Timer Timeout Mask (RTM)
11:09	RO	0	Reserved
08	RW	0	REPLAY_NUM Rollover Mask (RRM)
07	RW	0	Bad DLLP Mask (BDM)
06	RW	0	Bad TLP Mask (BTM)
05:01	RO	0	Reserved
00	RW	0	Receiver Error Mask (REM)

2.6.7 Offset AERCAP + 18h: AERCC – AER Capabilities and Control Register

Bits	Type	Reset	Description
31:12	RO	0	Reserved
11	RO	0	TLP Prefix Log Present (TPLP) : If set to '1' and FEP is valid, this indicates that the TLP Prefix Log register contains valid information. This field is sticky – it is neither initialized nor modified during a hot reset or FLR.
10	RW/RO	0	Multiple Header Recording Enable (MHRE) : If this field is set to '1', this enables the controller to generate more than one error header. This field is sticky – it is neither initialized nor modified during a hot reset or FLR. If the controller does not implement the associated mechanism, then this field is cleared to '0'.
09	RW/RO	Impl Spec	Multiple Header Recording Capable (MHRC) : If this field is set to '1', indicates that the controller is capable of generating more than one error header.
08	RW/RO	0	ECRC Check Enable (ECE) : If this field is set to '1', indicates that the ECRC checking is enabled. This field is sticky – it is neither initialized nor modified during a hot reset or FLR. If the controller does not implement the associated mechanism, then this field is cleared to '0'.
07	RO	Impl Spec	ECRC Check Capable (ECC) : If this field is set to '1', indicates that the controller is capable of checking ECRC.
06	RW/RO	0	ECRC Generation Enable (EGE) : If this field is set to '1', indicates that the ECRC generation is enabled. This field is sticky – it is neither initialized nor modified during a hot reset or FLR. If the controller does not implement the associated mechanism, then this field is cleared to '0'.
05	RO	Impl Spec	ECRC Generation Capable (EGC) : If this field is set to '1', indicates that the controller is capable of generating ECRC.
04:00	RO	0	First Error Pointer (FEP) : This field identifies the bit position of the first error reported in the AERUCES register. This field is sticky – it is neither initialized nor modified during a hot reset or FLR.

2.6.8 Offset AERCAP + 1Ch: AERHL – AER Header Log Register

This register contains the header for the TLP corresponding to a detected error. This register is sticky – it is neither initialized nor modified during a hot reset or FLR.

Byte	Type	Reset	Description
0	RO	0	Header Byte 3 (HB3)
1	RO	0	Header Byte 2 (HB2)
2	RO	0	Header Byte 1 (HB1)
3	RO	0	Header Byte 0 (HB0)
4	RO	0	Header Byte 7 (HB7)
5	RO	0	Header Byte 6 (HB6)
6	RO	0	Header Byte 5 (HB5)
7	RO	0	Header Byte 4 (HB4)
8	RO	0	Header Byte 11 (HB11)
9	RO	0	Header Byte 10 (HB10)
10	RO	0	Header Byte 9 (HB9)
11	RO	0	Header Byte 8 (HB8)
12	RO	0	Header Byte 15 (HB15)
13	RO	0	Header Byte 14 (HB14)
14	RO	0	Header Byte 13 (HB13)
15	RO	0	Header Byte 12 (HB12)

2.6.9 Offset AERCAP + 38h: AERTLP – AER TLP Prefix Log Register (Optional)

This register contains the End-End TLP prefix(es) for the TLP corresponding to a detected error. This register is sticky – it is neither initialized nor modified during a hot reset or FLR.

Byte	Type	Reset	Description
0	RO	0	First TLP Prefix Log Byte 3 (TPL1B3)
1	RO	0	First TLP Prefix Log Byte 2 (TPL1B2)
2	RO	0	First TLP Prefix Log Byte 1 (TPL1B1)
3	RO	0	First TLP Prefix Log Byte 0 (TPL1B0)
4	RO	0	Second TLP Prefix Log Byte 3 (TPL2B3)
5	RO	0	Second TLP Prefix Log Byte 2 (TPL2B2)
6	RO	0	Second TLP Prefix Log Byte 1 (TPL2B1)
7	RO	0	Second TLP Prefix Log Byte 0 (TPL2B0)
8	RO	0	Third TLP Prefix Log Byte 3 (TPL3B3)
9	RO	0	Third TLP Prefix Log Byte 2 (TPL3B2)
10	RO	0	Third TLP Prefix Log Byte 1 (TPL3B1)
11	RO	0	Third TLP Prefix Log Byte 0 (TPL3B0)
12	RO	0	Fourth TLP Prefix Log Byte 3 (TPL4B3)
13	RO	0	Fourth TLP Prefix Log Byte 2 (TPL4B2)
14	RO	0	Fourth TLP Prefix Log Byte 1 (TPL4B1)
15	RO	0	Fourth TLP Prefix Log Byte 0 (TPL4B0)

2.7 Other Capability Pointers

Though not mentioned in this specification, other capability pointers may be necessary, depending upon the implementation. Examples would be the PCI-X capability for PCI-X implementations, and potentially the vendor specific capability pointer.

These capabilities are beyond the scope of this specification.

3 Controller Registers

Controller registers are located in the MLBAR/MUBAR registers (PCI BAR0 and BAR1) that shall be mapped to a memory space that supports in-order access and variable access widths. For many computer architectures, specifying the memory space as uncacheable produces this behavior. Locked accesses are not supported and registers shall be accessed in their native width (16-bit registers should be accessed as a 16-bit value, 32-bit registers should be accessed as a 32-bit value, and 64-bit registers should be accessed as a 64-bit value). For example, the 32-bit Submission Queue 0 Tail Doorbell register should be accessed as a 32-bit value. If software cannot access the register in its native width due to limitations of the platform, then it should access the register in order starting with lower bytes first. For example, accessing a 64-bit register using 16-bit accesses would result in an access for bits 15:00, following by an access for bits 31:16, followed by an access for bits 47:32, and concluded with an access for bits 63:48.

Unaligned register accesses are not supported and are handled at the PCI Express layer with a PCI Express completer abort status, indicating a violation of the programming model.

All registers not defined and all reserved bits within registers are read-only and return 0h when read. Software shall not rely on 0h being returned.

3.1 Register Definition

The following table describes the register map for the controller.

Start	End	Symbol	Description
00h	07h	CAP	Controller Capabilities
08h	0Bh	VS	Version
0Ch	0Fh	INTMS	Interrupt Mask Set
10h	13h	INTMC	Interrupt Mask Clear
14h	17h	CC	Controller Configuration
18h	1Bh	Reserved	Reserved
1Ch	1Fh	CSTS	Controller Status
20h	23h	NSSR	NVM Subsystem Reset (Optional)
24h	27h	AQA	Admin Queue Attributes
28h	2Fh	ASQ	Admin Submission Queue Base Address
30h	37h	ACQ	Admin Completion Queue Base Address
38h	EFFh	Reserved	Reserved
F00h	FFFh	Reserved	Command Set Specific
1000h	1003h	SQ0TDBL	Submission Queue 0 Tail Doorbell (Admin)
1000h + (1 * (4 << CAP.DSTRD))	1003h + (1 * (4 << CAP.DSTRD))	CQ0HDBL	Completion Queue 0 Head Doorbell (Admin)
1000h + (2 * (4 << CAP.DSTRD))	1003h + (2 * (4 << CAP.DSTRD))	SQ1TDBL	Submission Queue 1 Tail Doorbell
1000h + (3 * (4 << CAP.DSTRD))	1003h + (3 * (4 << CAP.DSTRD))	CQ1HDBL	Completion Queue 1 Head Doorbell
1000h + (4 * (4 << CAP.DSTRD))	1003h + (4 * (4 << CAP.DSTRD))	SQ2TDBL	Submission Queue 2 Tail Doorbell
1000h + (5 * (4 << CAP.DSTRD))	1003h + (5 * (4 << CAP.DSTRD))	CQ2HDBL	Completion Queue 2 Head Doorbell
...
1000h + (2y * (4 << CAP.DSTRD))	1003h + (2y * (4 << CAP.DSTRD))	SQyTDBL	Submission Queue y Tail Doorbell
1000h + ((2y + 1) * (4 << CAP.DSTRD))	1003h + ((2y + 1) * (4 << CAP.DSTRD))	CQyHDBL	Completion Queue y Head Doorbell
			Vendor Specific (Optional)

3.1.1 Offset 00h: CAP – Controller Capabilities

This register indicates basic capabilities of the controller to host software.

Bit	Type	Reset	Description																		
63:56	RO	0h	Reserved																		
55:52	RO	Impl Spec	Memory Page Size Maximum (MPSMAX): This field indicates the maximum host memory page size that the controller supports. The maximum memory page size is $(2^{12 + MPSMAX})$. The host shall not configure a memory page size in CC.MPS that is larger than this value.																		
51:48	RO	Impl Spec	Memory Page Size Minimum (MPSMIN): This field indicates the minimum host memory page size that the controller supports. The minimum memory page size is $(2^{12 + MPSMIN})$. The host shall not configure a memory page size in CC.MPS that is smaller than this value.																		
47:45	RO	0h	Reserved																		
44:37	RO	Impl Spec	<p>Command Sets Supported (CSS): This field indicates the I/O Command Set(s) that the controller supports. A minimum of one command set shall be supported. The field is bit significant. If a bit is set to '1', then the corresponding I/O Command Set is supported. If a bit is cleared to '0', then the corresponding I/O Command Set is not supported.</p> <table border="1"> <thead> <tr> <th>Bit</th> <th>Definition</th> </tr> </thead> <tbody> <tr> <td>37</td> <td>NVM command set</td> </tr> <tr> <td>38</td> <td>Reserved</td> </tr> <tr> <td>39</td> <td>Reserved</td> </tr> <tr> <td>40</td> <td>Reserved</td> </tr> <tr> <td>41</td> <td>Reserved</td> </tr> <tr> <td>42</td> <td>Reserved</td> </tr> <tr> <td>43</td> <td>Reserved</td> </tr> <tr> <td>44</td> <td>Reserved</td> </tr> </tbody> </table>	Bit	Definition	37	NVM command set	38	Reserved	39	Reserved	40	Reserved	41	Reserved	42	Reserved	43	Reserved	44	Reserved
Bit	Definition																				
37	NVM command set																				
38	Reserved																				
39	Reserved																				
40	Reserved																				
41	Reserved																				
42	Reserved																				
43	Reserved																				
44	Reserved																				
36	RO	Impl Spec	NVM Subsystem Reset Supported (NSSRS): This field indicates whether the controller supports the NVM Subsystem Reset feature defined in section 7.3.1. This field is set to '1' if the controller supports the NVM Subsystem Reset feature. This field is cleared to '0' if the controller does not support the NVM Subsystem Reset feature.																		
35:32	RO	Impl Spec	Doorbell Stride (DSTRD): Each Submission Queue and Completion Queue Doorbell register is 32-bits in size. This register indicates the stride between doorbell registers. The stride is specified as $(2^{2 + DSTRD})$ in bytes. A value of 0h indicates a stride of 4 bytes, where the doorbell registers are packed without reserved space between each register. Refer to section 8.6.																		
31:24	RO	Impl Spec	Timeout (TO): This is the worst case time that host software shall wait for the controller to become ready (CSTS.RDY set to '1') after a power-on or reset (section 7.3). This worst case time may be experienced after an unclean shutdown; typical times are expected to be much shorter. This field is in 500 millisecond units.																		
23:19	RO	0h	Reserved																		
18:17	RO	Impl Spec	<p>Arbitration Mechanism Supported (AMS): This field is bit significant and indicates the optional arbitration mechanisms supported by the controller. If a bit is set to '1', then the corresponding arbitration mechanism is supported by the controller. Refer to section 4.8 for arbitration details.</p> <table border="1"> <thead> <tr> <th>Bit</th> <th>Definition</th> </tr> </thead> <tbody> <tr> <td>17</td> <td>Weighted Round Robin with Urgent</td> </tr> <tr> <td>18</td> <td>Vendor Specific</td> </tr> </tbody> </table> <p>The round robin arbitration mechanism is not listed since all controllers shall support this arbitration mechanism.</p>	Bit	Definition	17	Weighted Round Robin with Urgent	18	Vendor Specific												
Bit	Definition																				
17	Weighted Round Robin with Urgent																				
18	Vendor Specific																				

Bit	Type	Reset	Description
16	RO	Impl Spec	Contiguous Queues Required (CQR): This field is set to '1' if the controller requires that I/O Submission Queues and I/O Completion Queues are required to be physically contiguous. This field is cleared to '0' if the controller supports I/O Submission Queues and I/O Completion Queues that are not physically contiguous. If this field is set to '1', then the Physically Contiguous bit (CDW11.PC) in the Create I/O Submission Queue and Create I/O Completion Queue commands shall be set to '1'.
15:00	RO	Impl Spec	Maximum Queue Entries Supported (MQES): This field indicates the maximum individual queue size that the controller supports. This value applies to each of the I/O Submission Queues and I/O Completion Queues that host software may create. This is a 0's based value. The minimum value is 1h, indicating two entries.

3.1.2 Offset 08h: VS – Version

This register indicates the major and minor version of the NVM Express specification that the controller implementation supports. The upper two bytes represent the major version number, and the lower two bytes represent the minor version number. Example: Version 3.12 would be represented as 00030102h. Valid versions of the specification are: 1.0.

3.1.2.1 VS Value for 1.0 Compliant Controllers

Bit	Type	Reset	Description
31:16	RO	0001h	Major Version Number (MJR): Indicates the major version is "1"
15:00	RO	0000h	Minor Version Number (MNR): Indicates the minor version is "0".

3.1.3 Offset 0Ch: INTMS – Interrupt Mask Set

This register is used to mask interrupts when using pin-based interrupts, single message MSI, or multiple message MSI. When using MSI-X, the interrupt mask table defined as part of MSI-X should be used to mask interrupts. Host software shall not access this register when configured for MSI-X; any accesses when configured for MSI-X is undefined. For interrupt behavior requirements, refer to section 7.5.

Bit	Type	Reset	Description
31:00	RW1S	0h	Interrupt Vector Mask Set (IVMS): This field is bit significant. If a '1' is written to a bit, then the corresponding interrupt vector is masked. Writing a '0' to a bit has no effect. When read, this field returns the current interrupt mask value within the controller (not the value of this register). If a bit has a value of a '1', then the corresponding interrupt vector is masked. If a bit has a value of '0', then the corresponding interrupt vector is not masked.

3.1.4 Offset 10h: INTMC – Interrupt Mask Clear

This register is used to unmask interrupts when using pin-based interrupts, single message MSI, or multiple message MSI. When using MSI-X, the interrupt mask table defined as part of MSI-X should be used to unmask interrupts. Host software shall not access this register when configured for MSI-X; any accesses when configured for MSI-X is undefined. For interrupt behavior requirements, refer to section 7.5.

Bit	Type	Reset	Description
31:00	RW1C	0h	Interrupt Vector Mask Clear (IVMC): This field is bit significant. If a '1' is written to a bit, then the corresponding interrupt vector is unmasked. Writing a '0' to a bit has no effect. When read, this field returns the current interrupt mask value within the controller (not the value of this register). If a bit has a value of a '1', then the corresponding interrupt vector is masked, If a bit has a value of '0', then the corresponding interrupt vector is not masked.

3.1.5 Offset 14h: CC – Controller Configuration

This register modifies settings for the controller. Host software shall set the Arbitration Mechanism (CC.AMS), the Memory Page Size (CC.MPS), and the Command Set (CC.CSS) to valid values prior to enabling the controller by setting CC.EN to '1'.

Bit	Type	Reset	Description										
31:24	RO	0	Reserved										
23:20	RW	0	I/O Completion Queue Entry Size (IOCQES): This field defines the I/O Completion Queue entry size that is used for the selected I/O Command Set. The required and maximum values for this field are specified in the Identify Controller data structure in Figure 82 for each I/O Command Set. The value is in bytes and is specified as a power of two (2^n).										
19:16	RW	0	I/O Submission Queue Entry Size (IOSQES): This field defines the I/O Submission Queue entry size that is used for the selected I/O Command Set. The required and maximum values for this field are specified in the Identify Controller data structure in Figure 82 for each I/O Command Set. The value is in bytes and is specified as a power of two (2^n).										
15:14	RW	0h	<p>Shutdown Notification (SHN): This field is used to initiate shutdown processing when a shutdown is occurring, (i.e., a power down condition is expected.) For a normal shutdown notification, it is expected that the controller is given time to process the shutdown notification. For an abrupt shutdown notification, the host may not wait for shutdown processing to complete before power is lost.</p> <p>The shutdown notification values are defined as:</p> <table border="1"> <thead> <tr> <th>Value</th> <th>Definition</th> </tr> </thead> <tbody> <tr> <td>00b</td> <td>No notification; no effect</td> </tr> <tr> <td>01b</td> <td>Normal shutdown notification</td> </tr> <tr> <td>10b</td> <td>Abrupt shutdown notification</td> </tr> <tr> <td>11b</td> <td>Reserved</td> </tr> </tbody> </table> <p>This field should be written by host software prior to any power down condition and prior to any change of the PCI power management state. It is recommended that this field also be written prior to a warm reboot. To determine when shutdown processing is complete, refer to CSTS.SHST. Refer to section 7.6.2 for additional shutdown processing details.</p>	Value	Definition	00b	No notification; no effect	01b	Normal shutdown notification	10b	Abrupt shutdown notification	11b	Reserved
Value	Definition												
00b	No notification; no effect												
01b	Normal shutdown notification												
10b	Abrupt shutdown notification												
11b	Reserved												
13:11	RW	0h	<p>Arbitration Mechanism Selected (AMS): This field selects the arbitration mechanism to be used. This value shall only be changed when EN is cleared to '0'. Host software shall only set this field to supported arbitration mechanisms indicated in CAP.AMS. If this field is set to an unsupported value, the behavior is undefined.</p> <table border="1"> <thead> <tr> <th>Value</th> <th>Definition</th> </tr> </thead> <tbody> <tr> <td>000b</td> <td>Round Robin</td> </tr> <tr> <td>001b</td> <td>Weighted Round Robin with Urgent</td> </tr> <tr> <td>010b – 110b</td> <td>Reserved</td> </tr> <tr> <td>111b</td> <td>Vendor Specific</td> </tr> </tbody> </table>	Value	Definition	000b	Round Robin	001b	Weighted Round Robin with Urgent	010b – 110b	Reserved	111b	Vendor Specific
Value	Definition												
000b	Round Robin												
001b	Weighted Round Robin with Urgent												
010b – 110b	Reserved												
111b	Vendor Specific												
10:07	RW	0h	Memory Page Size (MPS): This field indicates the host memory page size. The memory page size is $(2^{(12 + MPS)})$. Thus, the minimum host memory page size is 4KB and the maximum host memory page size is 128MB. The value set by host software shall be a supported value as indicated by the CAP.MPSMAX and CAP.MPSMIN fields. This field describes the value used for PRP entry size.										
06:04	RW	0h	<p>I/O Command Set Selected (CSS): This field specifies the I/O Command Set that is selected for use for the I/O Submission Queues. Host software shall only select a supported I/O Command Set, as indicated in CAP.CSS. This field shall only be changed when the controller is disabled (CC.EN is cleared to '0'). The I/O Command Set selected shall be used for all I/O Submission Queues.</p> <table border="1"> <thead> <tr> <th>Value</th> <th>Definition</th> </tr> </thead> <tbody> <tr> <td>000b</td> <td>NVM Command Set</td> </tr> <tr> <td>001b – 111b</td> <td>Reserved</td> </tr> </tbody> </table>	Value	Definition	000b	NVM Command Set	001b – 111b	Reserved				
Value	Definition												
000b	NVM Command Set												
001b – 111b	Reserved												
03:01	RO	0	Reserved										

Bit	Type	Reset	Description
00	RW	0	<p>Enable (EN): When set to '1', then the controller shall process commands based on Submission Queue Tail doorbell writes. When cleared to '0', then the controller shall not process commands nor post completion queue entries to Completion Queues. When this field transitions from '1' to '0', the controller is reset (referred to as a Controller Reset). The reset deletes all I/O Submission Queues and I/O Completion Queues, resets the Admin Submission Queue and Completion Queue, and brings the hardware to an idle state. The reset does not affect PCI Express registers nor the Admin Queue registers (AQA, ASQ, or ACQ). All other controller registers defined in this section and internal controller state (e.g., Feature values defined in section 5.12.1 that are not persistent across power states) are reset to their default values. The controller shall ensure that there is no data loss for commands that have had corresponding completion queue entries posted to an I/O Completion Queue prior to the reset operation. Refer to section 7.3 for reset details.</p> <p>When this field is cleared to '0', the CSTS.RDY bit is cleared to '0' by the controller. When this field is set to '1', the controller sets CSTS.RDY to '1' when it is ready to process commands. The Admin Queue registers (AQA, ASQ, and ACQ) shall only be modified when EN is cleared to '0'.</p>

3.1.6 Offset 1Ch: CSTS – Controller Status

Bit	Type	Reset	Description										
31:05	RO	0	Reserved										
04	RW1C	Hwlnit	<p>NVM Subsystem Reset Occurred (NSSRO): The initial value of this field is '1' if the last occurrence of an NVM Subsystem Reset occurred while power was applied to the NVM subsystem. The initial value of this field is '0' following an NVM Subsystem Reset due to application of power to the NVM subsystem. This field is only valid if the controller supports the NVM Subsystem Reset feature defined in section 7.3.1 as indicated by CC.NSSRS set to '1'.</p> <p>The reset value of this field is '0' if an NVM Subsystem Reset causes activation of a new firmware image.</p>										
03:02	RO	0	<p>Shutdown Status (SHST): This field indicates the status of shutdown processing that is initiated by the host setting the CC.SHN field.</p> <p>The shutdown status values are defined as:</p> <table border="1"> <thead> <tr> <th>Value</th> <th>Definition</th> </tr> </thead> <tbody> <tr> <td>00b</td> <td>Normal operation (no shutdown has been requested)</td> </tr> <tr> <td>01b</td> <td>Shutdown processing occurring</td> </tr> <tr> <td>10b</td> <td>Shutdown processing complete</td> </tr> <tr> <td>11b</td> <td>Reserved</td> </tr> </tbody> </table> <p>To start executing commands on the controller after a shutdown operation (CSTS.SHST set to 10b), a reset (CC.EN cleared to '0') is required. If host software submits commands to the controller without issuing a reset, the behavior is undefined.</p>	Value	Definition	00b	Normal operation (no shutdown has been requested)	01b	Shutdown processing occurring	10b	Shutdown processing complete	11b	Reserved
Value	Definition												
00b	Normal operation (no shutdown has been requested)												
01b	Shutdown processing occurring												
10b	Shutdown processing complete												
11b	Reserved												
01	RO	Hwlnit	<p>Controller Fatal Status (CFS): This field is set to '1' when a fatal controller error occurred that could not be communicated in the appropriate Completion Queue. This field is cleared to '0' when a fatal controller error has not occurred. Refer to section 9.5.</p> <p>The reset value of this field is '1' when a fatal controller error is detected during controller initialization.</p>										

Bit	Type	Reset	Description
00	RO	0	Ready (RDY): This field is set to '1' when the controller is ready to process commands after CC.EN is set to '1'. This field shall be cleared to '0' when CC.EN is cleared to '0'. Commands shall not be submitted to the controller until this field is set to '1' after the CC.EN bit is set to '1'. Failure to follow this requirement produces undefined results. Host software shall wait a minimum of CAP.TO seconds for this field to be set to '1' after setting CC.EN to '1' from a previous value of '0'.

3.1.7 Offset 20h: NSSR – NVM Subsystem Reset

This optional register provides host software with the capability to initiate an NVM Subsystem Reset. Support for this register is indicated by the state of the NVM Subsystem Reset Supported (CAP.NSSRS) field. If the register is not supported, then the address range occupied by the register is reserved. Refer to section 7.3.1.

Bit	Type	Reset	Description
31:00	RW	0h	NVM Subsystem Reset Control (NSSRC): A write of the value 4E564D65h ("NVMe") to this field initiates an NVM Subsystem Reset. A write of any other value has no functional effect on the operation of the NVM subsystem. This field shall return the value 0h when read.

3.1.8 Offset 24h: AQA – Admin Queue Attributes

This register defines the attributes for the Admin Submission Queue and Admin Completion Queue. The Queue Identifier for the Admin Submission Queue and Admin Completion Queue is 0h. The Admin Submission Queue's priority is determined by the arbitration mechanism selected, refer to section 4.8. The Admin Submission Queue and Admin Completion Queue are required to be in physically contiguous memory.

Note: It is recommended that UEFI be used during boot operations. In low memory environments (like Option ROMs in legacy BIOS environments) there may not be sufficient available memory to allocate the necessary Submission and Completion Queues. In these types of conditions, low memory operation of the controller is vendor specific.

Bit	Type	Reset	Description
31:28	RO	0h	Reserved
27:16	RW	0h	Admin Completion Queue Size (ACQS): Defines the size of the Admin Completion Queue in entries. Refer to section 4.1.3. The minimum size of the Admin Completion Queue is two entries. The maximum size of the Admin Completion Queue is 4096 entries. This is a 0's based value.
15:12	RO	0h	Reserved
11:00	RW	0h	Admin Submission Queue Size (ASQS): Defines the size of the Admin Submission Queue in entries. Refer to section 4.1.3. The minimum size of the Admin Submission Queue is two entries. The maximum size of the Admin Submission Queue is 4096 entries. This is a 0's based value.

3.1.9 Offset 28h: ASQ – Admin Submission Queue Base Address

This register defines the base memory address of the Admin Submission Queue.

Bit	Type	Reset	Description
63:12	RW	Impl Spec	Admin Submission Queue Base (ASQB): Indicates the 64-bit physical address for the Admin Submission Queue. This address shall be memory page aligned (based on the value in CC.MPS). All Admin commands, including creation of I/O Submission Queues and I/O Completions Queues shall be submitted to this queue. For the definition of Submission Queues, refer to section 4.1.
11:00	RO	0h	Reserved

3.1.10 Offset 30h: ACQ – Admin Completion Queue Base Address

This register defines the base memory address of the Admin Completion Queue.

Bit	Type	Reset	Description
63:12	RW	Impl Spec	Admin Completion Queue Base (ACQB): Indicates the 64-bit physical address for the Admin Completion Queue. This address shall be memory page aligned (based on the value in CC.MPS). All completion queue entries for the commands submitted to the Admin Submission Queue shall be posted to this Completion Queue. This queue is always associated with interrupt vector 0. For the definition of Completion Queues, refer to section 4.1.
11:00	RO	0h	Reserved

3.1.11 Offset (1000h + ((2y) * (4 << CAP.DSTRD))): SQyTDBL – Submission Queue y Tail Doorbell

This register defines the doorbell register that updates the Tail entry pointer for Submission Queue y. The value of y is equivalent to the Queue Identifier. This indicates to the controller that new commands have been submitted for processing.

The host should not read the doorbell registers. If a doorbell register is read, the value returned is vendor specific. Writing a non-existent or unallocated Submission Queue Tail Doorbell has undefined results.

Bit	Type	Reset	Description
31:16	RO	0	Reserved
15:00	RW	0h	Submission Queue Tail (SQT): Indicates the new value of the Submission Queue Tail entry pointer. This value shall overwrite any previous Submission Queue Tail entry pointer value provided. The difference between the last SQT write and the current SQT write indicates the number of commands added to the Submission Queue. Note: Submission Queue rollover needs to be accounted for.

3.1.12 Offset (1000h + ((2y + 1) * (4 << CAP.DSTRD))): CQyHDBL – Completion Queue y Head Doorbell

This register defines the doorbell register that updates the Head entry pointer for Completion Queue y. The value of y is equivalent to the Queue Identifier. This indicates Completion Queue entries that have been processed by host software.

The host should not read the doorbell registers. If a doorbell register is read, the value returned is vendor specific. Writing a non-existent or unallocated Completion Queue Head Doorbell has undefined results.

Host software should ensure it continues to process completion queue entries within Completion Queues regardless of whether there are entries available in a particular or any Submission Queue.

Bit	Type	Reset	Description
31:16	RO	0	Reserved
15:00	RW	0h	Completion Queue Head (CQH): Indicates the new value of the Completion Queue Head entry pointer. This value shall overwrite any previous Completion Queue Head value provided. The difference between the last CQH write and the current CQH entry pointer write indicates the number of entries that are now available for re-use by the controller in the Completion Queue. Note: Completion Queue rollover needs to be accounted for.

3.2 Index/Data Pair registers (Optional)

Index/Data Pair registers provide host software with a mechanism to access the NVM Express memory mapped registers using I/O space based registers. If supported, these registers are located in BAR2. On PC based platforms, host software (BIOS, Option ROMs, OSEs) written to operate in 'real-mode' (8086 mode) are unable to access registers in a PCI Express function's address space, if the address space is memory mapped and mapped above 1MB.

The Index/Data Pair mechanism allows host software to access all of the memory mapped NVM Express registers using indirect I/O addressing in lieu of direct memory mapped access.

Note: UEFI drivers do not encounter the 1MB limitation, and thus when using EFI there is not a need for the Index/Data Pair mechanism. Thus, this feature is optional for the controller to support and may be obsolete as UEFI becomes pervasive.

3.2.1 Restrictions

Host software shall not alternate between Index/Data Pair based access and direct memory mapped access methods. After using direct memory mapped access to the controller registers, the Index/Data Pair mechanism shall not be used.

3.2.2 Register Definition

The following registers describe the registers necessary to implement Index/Data Pair.

Start	End	Symbol	Description
00h	03h	IDX	Index register
04h	07h	DAT	Data register

3.2.3 Offset 00h: IDX – Index Register

Bit	Type	Reset	Description
31:02	RW	0h	Index (IDX): This register selects the Dword offset of the memory mapped NVM Express register to be accessed within the MLBAR/MUBAR registers (PCI BAR0 and BAR1). Host software shall not set this to a value beyond the maximum register offset implemented.
01:00	RO	0h	Reserved

3.2.4 Offset 04h: DAT – Data Register

Bit	Type	Reset	Description
31:00	RW	na	Data (DAT): This register is a “window” through which data is read or written to the memory mapped register pointed to by the Index register. A physical register is not implemented as the data is actually stored in the memory mapped registers. Since this is not a physical register, the reset value is the same as the reset value of the register that the Index register is currently pointing to.

4 System Memory Structures

This section describes system memory structures used by NVM Express.

4.1 Submission Queue & Completion Queue Definition

The Head and Tail entry pointers correspond to the Completion Queue Head Doorbells and the Submission Queue Tail Doorbells defined in section 3.1.12 and 3.1.11. The doorbell registers are updated by host software.

The submitter of entries to a queue uses the current Tail entry pointer to identify the next open queue entry space. The submitter increments the Tail entry pointer after submitting the new entry to the open queue entry space. If the Tail entry pointer increment exceeds the queue size, the Tail entry shall roll to zero. The submitter may continue to submit entries to the queue as long as the Full queue condition is not met (refer to section 4.1.2).

Note: The submitter shall take queue wrap conditions into account.

The consumer of entries on a queue uses the current Head entry pointer to identify the next entry to be pulled off the queue. The consumer increments the Head entry pointer after retrieving the next entry from the queue. If the Head entry pointer increment exceeds the queue size, the Head entry pointer shall roll to zero. The consumer may continue to remove entries from the queue as long as the Empty queue condition is not met (refer to section 4.1.1).

Note: The consumer shall take queue wrap conditions into account.

Creation and deletion of Submission Queue and associated Completion Queues need to be ordered correctly by host software. Host software shall create the Completion Queue before creating any associated Submission Queue. Submission Queues may be created at any time after the associated Completion Queue is created. Host software shall delete all associated Submission Queues prior to deleting a Completion Queue. Host software should only delete a Submission Queue after it has been brought to an idle condition with no outstanding commands.

If host software writes an invalid value to the Submission Queue Tail Doorbell or Completion Queue Head Doorbell register and an Asynchronous Event Request command is outstanding, then an asynchronous event is posted to the Admin Completion Queue with a status code of Invalid Doorbell Write Value. The associated queue should be deleted and recreated by host software. For a Submission Queue that experiences this error, the controller may complete previously fetched commands; no additional commands are fetched. This condition may be caused by host software attempting to add an entry to a full Submission Queue or remove an entry from an empty Completion Queue.

The behavior if a command is overwritten is undefined.

If there are no free completion queue entries in a Completion Queue, then the controller shall not post status to that Completion Queue until completion queue entries become available. In this case, the controller may stop processing additional Submission Queue entries associated with the affected Completion Queue until completion queue entries become available. The controller shall continue processing for other queues.

4.1.1 Empty Queue

The queue is Empty when the Head entry pointer equals the Tail entry pointer. Figure 8 defines the Empty Queue condition.

Figure 8: Empty Queue Definition

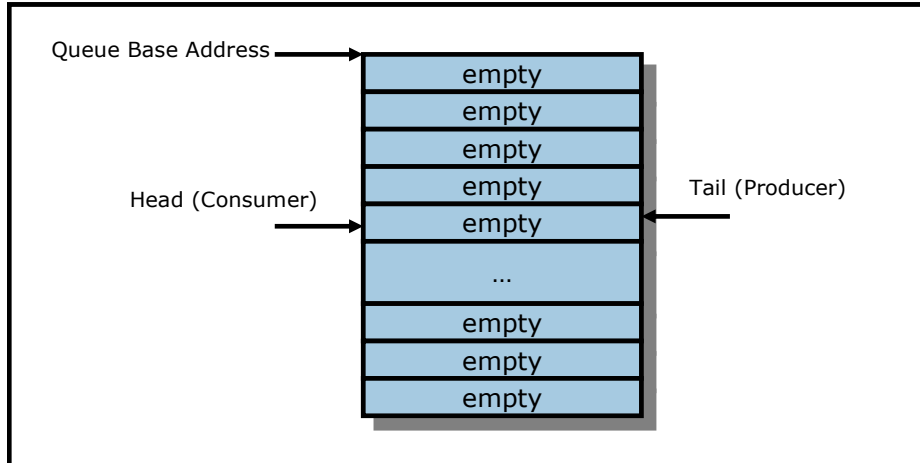

4.1.2 Full Queue

The queue is Full when the Head equals one more than the Tail. The number of entries in a queue when full is one less than the queue size. Figure 9 defines the Full Queue condition.

Note: Queue wrap conditions shall be taken into account when determining whether a queue is Full.

Figure 9: Full Queue Definition

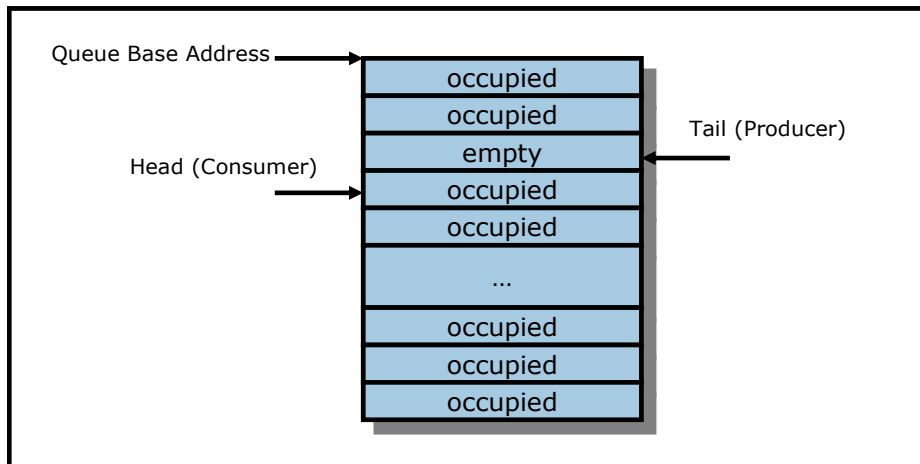

4.1.3 Queue Size

The Queue Size is indicated in a 16-bit 0's based field that indicates the number of entries in the queue. The minimum size for a queue is two entries. The maximum size for either an I/O Submission Queue or an I/O Completion Queue is defined as 64K entries, limited by the maximum queue size supported by the controller that is reported in the CAP.MQES field. The maximum size for the Admin Submission and

Admin Completion Queue is defined as 4K entries. One entry in each queue is not available for use due to Head and Tail entry pointer definition.

4.1.4 Queue Identifier

Each queue is identified through a 16-bit ID value that is assigned to the queue when it is created.

4.1.5 Queue Priority

If the weighted round robin with urgent priority class arbitration mechanism is supported, then host software may assign a queue priority service class of Urgent, High, Medium or Low. If the weighted round robin with urgent priority class arbitration mechanism is not supported, then the priority setting is not used and is ignored by the controller.

4.2 Submission Queue Entry – Command Format

Each command is 64 bytes in size.

Command Dword 0, Namespace Identifier, Metadata Pointer, PRP Entry 1, and PRP Entry 2 have common definitions for all Admin commands and NVM commands. SGL Entry 1 and Metadata SGL Segment Pointer have common definitions for all NVM commands (SGLs are not used for Admin commands). Metadata Pointer, PRP Entry 1, PRP Entry 2, and Metadata SGL Segment Pointer are not used by all commands. Command Dword 0 is defined in Figure 10 .

Figure 10: Command Dword 0

Bit	Description										
31:16	Command Identifier (CID): This field specifies a unique identifier for the command when combined with the Submission Queue identifier.										
15	PRP or SGL for Data Transfer (PSDT): This field specifies whether PRPs or SGLs are used for any data transfer associated with the command. If cleared to '0', the command uses PRPs for any associated data or metadata transfer. If set to '1', the command uses SGLs for any associated data or metadata transfer. PRPs shall be used for all Admin commands.										
14:10	Reserved										
09:08	<p>Fused Operation (FUSE): In a fused operation, a complex command is created by “fusing” together two simpler commands. Refer to section 6.1. This field specifies whether this command is part of a fused operation and if so, which command it is in the sequence.</p> <table border="1"> <thead> <tr> <th>Bits</th> <th>Definition</th> </tr> </thead> <tbody> <tr> <td>00b</td> <td>Normal operation</td> </tr> <tr> <td>01b</td> <td>Fused operation, first command</td> </tr> <tr> <td>10b</td> <td>Fused operation, second command</td> </tr> <tr> <td>11b</td> <td>Reserved</td> </tr> </tbody> </table>	Bits	Definition	00b	Normal operation	01b	Fused operation, first command	10b	Fused operation, second command	11b	Reserved
Bits	Definition										
00b	Normal operation										
01b	Fused operation, first command										
10b	Fused operation, second command										
11b	Reserved										
07:00	Opcode (OPC): This field specifies the opcode of the command to be executed.										

The 64 byte command format for the Admin Command Set and NVM Command Set is defined in Figure 11. Any additional I/O Command Set defined in the future may use an alternate command size or format.

Figure 11: Command Format – Admin Command Set

Bytes	Description
63:60	Command Dword 15 (CDW15): This field is command specific Dword 15.
59:56	Command Dword 14 (CDW14): This field is command specific Dword 14.
55:52	Command Dword 13 (CDW13): This field is command specific Dword 13.
51:48	Command Dword 12 (CDW12): This field is command specific Dword 12.
47:44	Command Dword 11 (CDW11): This field is command specific Dword 11.
43:40	Command Dword 10 (CDW10): This field is command specific Dword 10.
39:32	PRP Entry 2 (PRP2): This field contains the second PRP entry for the command or if the data transfer spans more than two memory pages, then this field is a PRP List pointer.
31:24	PRP Entry 1 (PRP1): This field contains the first PRP entry for the command or a PRP List pointer depending on the command.
23:16	Metadata Pointer (MPTR): This field contains the address of a contiguous physical buffer of metadata. This field is only used if metadata is not interleaved with the logical block data, as specified in the Format NVM command. This field shall be Dword aligned.
15:08	Reserved
07:04	<p>Namespace Identifier (NSID): This field specifies the namespace ID that this command applies to. If the namespace ID is not used for the command, then this field shall be cleared to 0h. If a command shall be applied to all namespaces on the device, then this field shall be set to FFFFFFFh.</p> <p>Unless otherwise noted, specifying an inactive namespace ID in a command that uses the namespace ID shall cause the controller to abort the command with status Invalid Field in Command. Specifying an invalid namespace ID in a command that uses the namespace ID shall cause the controller to abort the command with status Invalid Namespace or Format.</p>
03:00	Command Dword 0 (CDW0): This field is common to all commands and is defined in Figure 10.

Figure 12: Command Format – NVM Command Set

Bytes	Description						
63:60	Command Dword 15 (CDW15): This field is command specific Dword 15.						
59:56	Command Dword 14 (CDW14): This field is command specific Dword 14.						
55:52	Command Dword 13 (CDW13): This field is command specific Dword 13.						
51:48	Command Dword 12 (CDW12): This field is command specific Dword 12.						
47:44	Command Dword 11 (CDW11): This field is command specific Dword 11.						
43:40	Command Dword 10 (CDW10): This field is command specific Dword 10.						
39:24	<p>If CDW0[15] is cleared to '0', then the definition of this field is:</p> <table border="1"> <tr> <td>39:32</td> <td>PRP Entry 2 (PRP2): This field contains the second PRP entry for the command or if the data transfer spans more than two memory pages, then this field is a PRP List pointer.</td> </tr> <tr> <td>31:24</td> <td>PRP Entry 1 (PRP1): This field contains the first PRP entry for the command or a PRP List pointer depending on the command.</td> </tr> </table> <p>If CDW0[15] is set to '1', then the definition of this field is:</p> <table border="1"> <tr> <td>39:24</td> <td>SGL Entry 1 (SGL1): This field contains the first SGL segment for the command. If the SGL segment is a Data Block descriptor, then it describes the entire data transfer. If more than one SGL segment is needed to describe the data transfer, then the first SGL segment is a Segment, or Last Segment descriptor. Refer to section 4.4 for the definition of SGL segments and descriptor types.</td> </tr> </table>	39:32	PRP Entry 2 (PRP2): This field contains the second PRP entry for the command or if the data transfer spans more than two memory pages, then this field is a PRP List pointer.	31:24	PRP Entry 1 (PRP1): This field contains the first PRP entry for the command or a PRP List pointer depending on the command.	39:24	SGL Entry 1 (SGL1): This field contains the first SGL segment for the command. If the SGL segment is a Data Block descriptor, then it describes the entire data transfer. If more than one SGL segment is needed to describe the data transfer, then the first SGL segment is a Segment, or Last Segment descriptor. Refer to section 4.4 for the definition of SGL segments and descriptor types.
	39:32	PRP Entry 2 (PRP2): This field contains the second PRP entry for the command or if the data transfer spans more than two memory pages, then this field is a PRP List pointer.					
31:24	PRP Entry 1 (PRP1): This field contains the first PRP entry for the command or a PRP List pointer depending on the command.						
39:24	SGL Entry 1 (SGL1): This field contains the first SGL segment for the command. If the SGL segment is a Data Block descriptor, then it describes the entire data transfer. If more than one SGL segment is needed to describe the data transfer, then the first SGL segment is a Segment, or Last Segment descriptor. Refer to section 4.4 for the definition of SGL segments and descriptor types.						
23:16	<p>If CDW0[15] is cleared to '0', then the definition of this field is:</p> <table border="1"> <tr> <td>23:16</td> <td>Metadata Pointer (MPTR): This field contains the address of a contiguous physical buffer of metadata. This field is only used if metadata is not interleaved with the logical block data, as specified in the Format NVM command. This field shall be Dword aligned.</td> </tr> </table> <p>If CDW0[15] is set to '1', then the definition of this field is:</p> <table border="1"> <tr> <td>23:16</td> <td>Metadata SGL Segment Pointer (MSGLP): This field contains the address of an SGL segment which describes the metadata to transfer. This field is only used if metadata is not interleaved with the logical block data, as specified in the Format NVM command. This field shall be Qword aligned. Refer to section 4.4.</td> </tr> </table>	23:16	Metadata Pointer (MPTR): This field contains the address of a contiguous physical buffer of metadata. This field is only used if metadata is not interleaved with the logical block data, as specified in the Format NVM command. This field shall be Dword aligned.	23:16	Metadata SGL Segment Pointer (MSGLP): This field contains the address of an SGL segment which describes the metadata to transfer. This field is only used if metadata is not interleaved with the logical block data, as specified in the Format NVM command. This field shall be Qword aligned. Refer to section 4.4.		
	23:16	Metadata Pointer (MPTR): This field contains the address of a contiguous physical buffer of metadata. This field is only used if metadata is not interleaved with the logical block data, as specified in the Format NVM command. This field shall be Dword aligned.					
23:16	Metadata SGL Segment Pointer (MSGLP): This field contains the address of an SGL segment which describes the metadata to transfer. This field is only used if metadata is not interleaved with the logical block data, as specified in the Format NVM command. This field shall be Qword aligned. Refer to section 4.4.						
15:08	Reserved						
07:04	Namespace Identifier (NSID): This field specifies the namespace that this command applies to. If the namespace is not used for the command, then this field shall be cleared to 0h. If a command shall be applied to all namespaces on the device, then this value shall be set to FFFFFFFh.						
03:00	Command Dword 0 (CDW0): This field is common to all commands and is defined in Figure 10.						

In addition to the fields commonly defined for all Admin and NVM commands, Admin and NVM Vendor Specific commands may support the Number of Dwords in Data Transfer and Number of Dwords in MPTR fields. If supported, the command format for the Admin Vendor Specific Command and NVM Vendor Specific Commands are defined in Figure 13. For more details, refer to section 8.7.

Figure 13: Command Format – Admin and NVM Vendor Specific Commands (Optional)

Bytes	Description
63:60	Command Dword 15 (CDW15): This field is command specific Dword 15.
59:56	Command Dword 14 (CDW14): This field is command specific Dword 14.
55:52	Command Dword 13 (CDW13): This field is command specific Dword 13.
51:48	Command Dword 12 (CDW12): This field is command specific Dword 12.
47:44	Number of Dwords in MPTR (NDM): This field indicates the number of Dwords in the metadata transfer.
43:40	Number of Dwords in Data Transfer (NDT): This field indicates the number of Dwords in the data transfer.
39:16	Refer to Figure 11 for the definition of these fields if it is an Admin command. Refer to Figure 12 for the definition of these fields if it is an NVM or NVM Vendor Specific command.
15:08	Reserved
07:04	Namespace Identifier (NSID): This field indicates the namespace ID that this command applies to. If the namespace ID is not used for the command, then this field shall be cleared to 0h. If a command shall be applied to all namespaces on the device, then this field shall be set to FFFFFFFh. The behavior of a controller in response to an inactive namespace ID for a vendor specific command is vendor specific. Specifying an invalid namespace ID in a command that uses the namespace ID shall cause the controller to abort the command with status Invalid Namespace or Format.
03:00	Command Dword 0 (CDW0): This field is common to all commands and is defined in Figure 10.

4.3 Physical Region Page Entry and List

A physical region page (PRP) entry is a pointer to a physical memory page. PRPs are used as a scatter/gather mechanism for data transfers between the controller and system memory. To enable efficient out of order data transfers between the device and the host, PRP entries are a fixed size.

The size of the physical memory page is configured by host software in CC.MPS. Figure 14 shows the layout of a PRP entry that consists of a Page Base Address and an Offset. The size of the Offset field is determined by the physical memory page size configured in CC.MPS.

Figure 14: PRP Entry Layout

The definition of a PRP entry is described in Figure 15.

Figure 15: PRP Entry – Page Base Address and Offset

Bit	Description
63:02	Page Base Address and Offset (PBAO): This field indicates the 64-bit physical memory page address. The lower bits ($n:2$) of this field indicate the offset within the memory page. If the memory page size is 4KB, then bits 11:02 form the Offset; if the memory page size is 8KB, then bits 12:02 form the Offset, etc. If this entry is not the first PRP entry in the command or in the PRP List then the Offset portion of this field shall be cleared to 0h.
01:00	Reserved

A physical region page list (PRP List) is a set of PRP entries in a single page of contiguous memory. A PRP List describes additional PRP entries that could not be described within the command itself. Any

PRP entries described within the command are not duplicated in a PRP List. If the amount of data to transfer requires multiple PRP List memory pages, then the last PRP entry before the end of the memory page shall be a pointer to the next PRP List, indicating the next segment of the PRP List. Figure 16 shows the layout of a PRP List.

Figure 16: PRP List Layout

63	$n+1$ n	0
Page Base Address k		0h
Page Base Address $k+1$		0h
...		
Page Base Address $k+m$		0h
Page Base Address $k+m+1$		0h

The first PRP entry contained within the command may have a non-zero offset within the memory page. The first PRP List entry (i.e. the first pointer to a memory page containing additional PRP entries) that if present is contained in the PRP Entry 2 location within the command, shall be Qword aligned and may also have a non-zero offset within the memory page. All other PRP and PRP List entries shall have a memory page offset of 0h, i.e. the entries are memory page aligned based on the value in CC.MPS. The last entry within a memory page, as indicated by the memory page size in the CC.MPS field, shall be a PRP List pointer if there is more than a single memory page of data to be transferred.

PRP Lists shall be minimally sized with packed entries starting with entry 0. If more PRP List pages are required, then the last entry of the PRP List page is a pointer to the next PRP List page. The total number of PRP entries is implied by the command parameters and memory page size.

4.4 Scatter Gather List (SGL)

A Scatter Gather List (SGL) is a data structure in memory address space used to describe a data buffer. A data buffer is either a source buffer or a destination buffer. There is no alignment requirement for the data buffer. An SGL contains one or more SGL segments.

An SGL segment is a Qword aligned data structure in a contiguous region of physical memory describing all, part of, or none of a data buffer and the next SGL segment, if any. An SGL segment consists of an array of one or more SGL descriptors. Only the last descriptor in an SGL segment may be an SGL Segment descriptor or an SGL Last Segment descriptor.

A last SGL segment is an SGL segment that does not contain an SGL Segment descriptor, or an SGL Last Segment descriptor.

A command shall be aborted if:

- an SGL segment contains greater than one SGL Segment descriptors, and/or SGL Last Segment descriptors; or
- an SGL segment contains an SGL Segment descriptor or an SGL Last Segment descriptor in other than the last descriptor in the segment; or
- a last SGL segment contains an SGL Segment descriptor, or an SGL Last Segment descriptor.

Figure 17 defines the SGL segment.

Figure 17: SGL Segment

Bytes	Description
15:00	SGL Descriptor 0
31:16	SGL Descriptor 1
...	...
$((n*16)+15):$ $(n*16)$	SGL Descriptor n

An SGL segment contains one or more SGL descriptors. Figure 18 defines the SGL descriptor format.

Figure 18: SGL Descriptor Format

Bytes	Description						
14:00	Descriptor Type Specific						
15	<p>SGL Identifier: The definition of this field is described in the table below.</p> <table border="1"> <thead> <tr> <th>Bits</th> <th>Description</th> </tr> </thead> <tbody> <tr> <td>03:00</td> <td>Descriptor Type Specific</td> </tr> <tr> <td>07:04</td> <td>SGL Descriptor Type</td> </tr> </tbody> </table>	Bits	Description	03:00	Descriptor Type Specific	07:04	SGL Descriptor Type
Bits	Description						
03:00	Descriptor Type Specific						
07:04	SGL Descriptor Type						

The SGL Descriptor Type field defined in Figure 19 specifies the SGL descriptor type. If the SGL Descriptor Type field is set to a reserved or unsupported value, then the SGL descriptor shall be processed as having an error.

An SGL descriptor set to all zeros is an SGL Data Block descriptor with the Address field set to 00000000_00000000h and the Length field set to 00000000h may be used as a NULL descriptor.

Figure 19: SGL Descriptor Type

Code	Descriptor
0h	SGL Data Block descriptor
1h	SGL Bit Bucket descriptor
2h	SGL Segment descriptor
3h	SGL Last Segment descriptor
4h – Eh	Reserved
Fh	Vendor specific

The SGL Data Block descriptor, defined in Figure 20, describes a data block.

Figure 20: SGL Data Block descriptor

Bytes	Description						
7:0	Address: The Address field specifies the starting 64-bit memory byte address of the data block.						
11:8	Length: The Length field specifies the length in bytes of the data block. A Length field set to 00000000h specifies that no data is transferred. An SGL Data Block descriptor specifying that no data is transferred is a valid SGL Data Block descriptor. If the value in the Address field plus the value in the Length field is greater than 1_00000000_00000000h then the SGL Data Block descriptor shall be processed as having an error.						
14:12	Reserved						
15	SGL Identifier: The definition of this field is described in the table below. <table border="1" data-bbox="456 611 1320 749"> <thead> <tr> <th>Bits</th> <th>Description</th> </tr> </thead> <tbody> <tr> <td>03:00</td> <td>Zero: The Zero field shall have the value of 0h. An SGL Data Block descriptor containing a Zero field set to a value other than 0h shall be processed as having an error.</td> </tr> <tr> <td>07:04</td> <td>SGL Descriptor Type: 0h as specified in Figure 19.</td> </tr> </tbody> </table>	Bits	Description	03:00	Zero: The Zero field shall have the value of 0h. An SGL Data Block descriptor containing a Zero field set to a value other than 0h shall be processed as having an error.	07:04	SGL Descriptor Type: 0h as specified in Figure 19.
Bits	Description						
03:00	Zero: The Zero field shall have the value of 0h. An SGL Data Block descriptor containing a Zero field set to a value other than 0h shall be processed as having an error.						
07:04	SGL Descriptor Type: 0h as specified in Figure 19.						

The SGL Bit Bucket descriptor, defined in Figure 21, is used to ignore parts of source data.

Figure 21: SGL Bit Bucket descriptor

Bytes	Description						
7:0	Reserved						
11:8	Length: If the SGL describes a destination data buffer, then the Length field specifies the number of bytes of the source data not to be transferred (i.e., the number of bytes to be discarded). A Length field set to 00000000h specifies that no source data shall be discarded. An SGL Bit Bucket descriptor specifying that no source data be discarded is a valid SGL Bit Bucket descriptor. If the SGL describes a source data buffer (i.e., a write from host memory to the controller) then the Length field shall be ignored and no data shall be discarded from the source data or destination data. An SGL Bit Bucket descriptor specifying that no data be discarded shall not be processed as having an error.						
14:12	Reserved						
15	SGL Identifier: The definition of this field is described in the table below. <table border="1" data-bbox="456 1367 1320 1509"> <thead> <tr> <th>Bits</th> <th>Description</th> </tr> </thead> <tbody> <tr> <td>03:00</td> <td>Zero: The Zero field shall have the value of 0h. An SGL Bit Bucket descriptor containing a Zero field set to a value other than 0h shall be processed as having an error.</td> </tr> <tr> <td>07:04</td> <td>SGL Descriptor Type: 1h as specified in Figure 19.</td> </tr> </tbody> </table>	Bits	Description	03:00	Zero: The Zero field shall have the value of 0h. An SGL Bit Bucket descriptor containing a Zero field set to a value other than 0h shall be processed as having an error.	07:04	SGL Descriptor Type: 1h as specified in Figure 19.
Bits	Description						
03:00	Zero: The Zero field shall have the value of 0h. An SGL Bit Bucket descriptor containing a Zero field set to a value other than 0h shall be processed as having an error.						
07:04	SGL Descriptor Type: 1h as specified in Figure 19.						

The SGL Segment descriptor, defined in Figure 22, describes the next SGL segment, which is not the last SGL segment.

Figure 22: SGL Segment descriptor

Bytes	Description						
7:0	Address: The Address field specifies the starting 64-bit memory byte address of the next SGL segment, which is a SGL segment.						
11:8	Length: The Length field specifies the length in bytes of the next SGL segment. The Length field shall be a non-zero value and a multiple of 16. If the value in the Address field plus the value in the Length field is greater than 1_00000000_00000000h, then the SGL Segment descriptor shall be processed as having an error.						
14:12	Reserved						
15	SGL Identifier: The definition of this field is described in the table below. <table border="1" style="margin-left: 40px;"> <thead> <tr> <th>Bits</th> <th>Description</th> </tr> </thead> <tbody> <tr> <td>03:00</td> <td>Zero: The Zero field shall have the value of 0h. An SGL Segment descriptor containing a Zero field set to a value other than 0h shall be processed as having an error.</td> </tr> <tr> <td>07:04</td> <td>SGL Descriptor Type: 2h as specified in Figure 19.</td> </tr> </tbody> </table>	Bits	Description	03:00	Zero: The Zero field shall have the value of 0h. An SGL Segment descriptor containing a Zero field set to a value other than 0h shall be processed as having an error.	07:04	SGL Descriptor Type: 2h as specified in Figure 19.
Bits	Description						
03:00	Zero: The Zero field shall have the value of 0h. An SGL Segment descriptor containing a Zero field set to a value other than 0h shall be processed as having an error.						
07:04	SGL Descriptor Type: 2h as specified in Figure 19.						

The SGL Last Segment descriptor, defined in Figure 23, describes the next and last SGL segment. A last SGL segment that contains an SGL Segment descriptor or an SGL Last Segment descriptor is processed as an error.

Figure 23: SGL Last Segment descriptor

Bytes	Description						
7:0	Address: The Address field specifies the starting 64-bit memory byte address of the next and last SGL segment, which is a SGL segment.						
11:8	Length: The Length field specifies the length in bytes of the next and last SGL segment. The Length field shall be a non-zero value and a multiple of 16. If the value in the Address field plus the value in the Length field is greater than 1_00000000_00000000h, then the SGL Last Segment descriptor shall be processed as having an error.						
14:12	Reserved						
15	SGL Identifier: The definition of this field is described in the table below. <table border="1" style="margin-left: 40px;"> <thead> <tr> <th>Bits</th> <th>Description</th> </tr> </thead> <tbody> <tr> <td>03:00</td> <td>Zero: The Zero field shall have the value of 0h. An SGL Last Segment descriptor containing a Zero field set to a value other than 0h shall be processed as having an error.</td> </tr> <tr> <td>07:04</td> <td>SGL Descriptor Type: 3h as specified in Figure 19.</td> </tr> </tbody> </table>	Bits	Description	03:00	Zero: The Zero field shall have the value of 0h. An SGL Last Segment descriptor containing a Zero field set to a value other than 0h shall be processed as having an error.	07:04	SGL Descriptor Type: 3h as specified in Figure 19.
Bits	Description						
03:00	Zero: The Zero field shall have the value of 0h. An SGL Last Segment descriptor containing a Zero field set to a value other than 0h shall be processed as having an error.						
07:04	SGL Descriptor Type: 3h as specified in Figure 19.						

4.4.1 SGL Example

Figure 24 shows an example of a data read request using SGLs. The total length of the logical blocks accessed on the device is 13KB, of which only 11KB is transferred to the host. There are three SGL segments describing the locations in host memory where the logical block data is transferred. In the example, the logical block size is 512B.

The three SGL segments contain a total of three Data Block descriptors with lengths of 3 KB, 4 KB and 4 KB respectively. Segment 1 of the Destination SGL contains a Bit Bucket descriptor with a length of 2 KB

that specifies to not transfer (i.e., ignore) 2 KB of logical block data from the device. Segment 1 of the destination SGL also contains a Last Segment descriptor specifying that the segment pointed to by the descriptor is the last SGL segment.

Figure 24: SGL Read Example

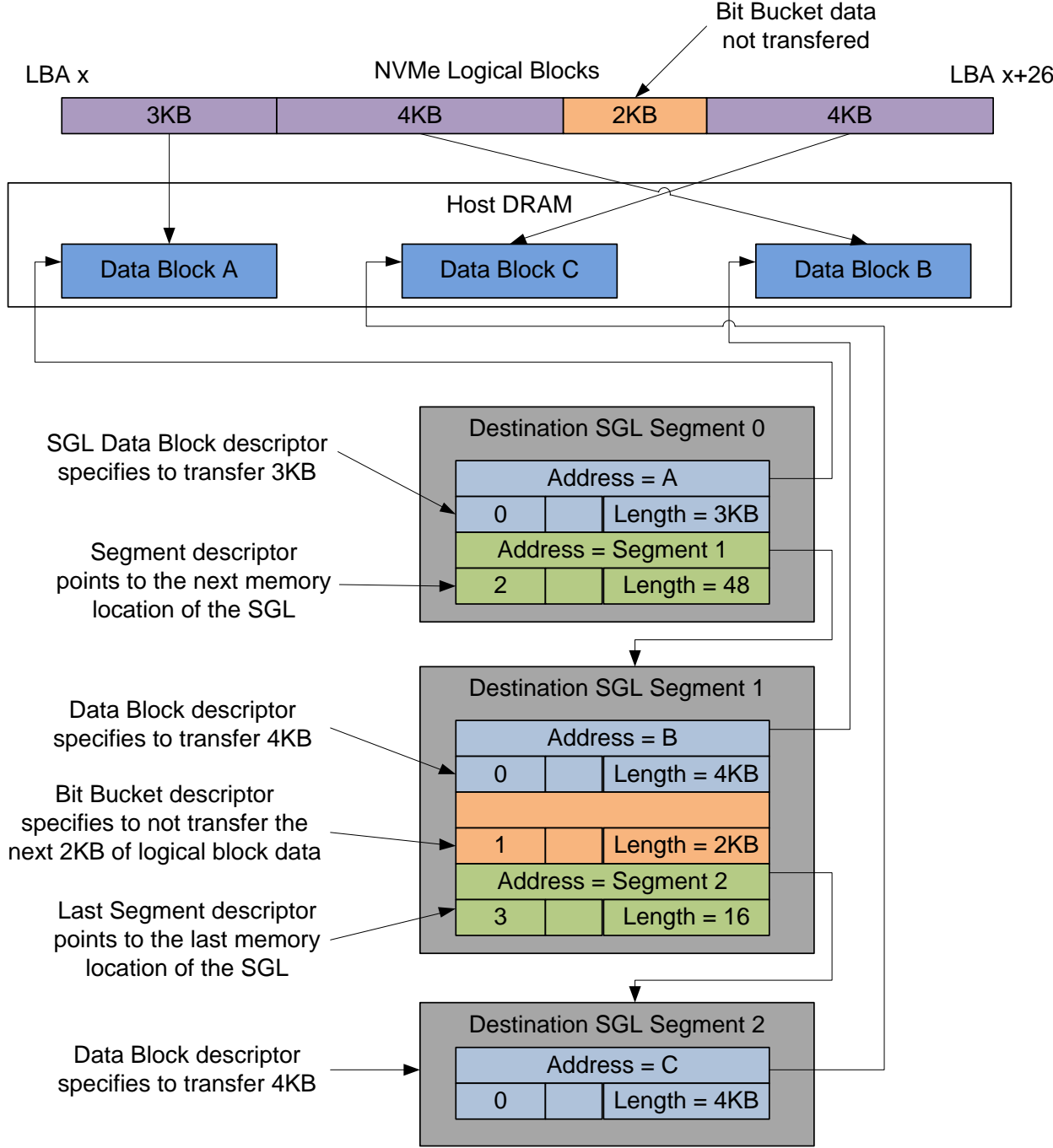

4.5 Metadata Region (MR)

Metadata may be supported for a namespace as either part of the logical block (creating an extended logical block which is a larger logical block that is exposed to the application) or it may be transferred as a separate contiguous buffer of data. The metadata shall not be split between the logical block and a separate metadata buffer. For writes, the metadata shall be written atomically with its associated logical block. Refer to section 8.2.

In the case where the namespace is formatted to transfer the metadata as a separate contiguous buffer of data, then the Metadata Region is used. In this case, the location of the Metadata Region is indicated by the Metadata Pointer within the command. The Metadata (SGL Segment) Pointer within the command shall be Dword aligned.

The controller may support several physical formats of logical block size and associated metadata size. There may be performance differences between different physical formats. This is indicated as part of the Identify Namespace data structure.

If the namespace is formatted to use end-to-end data protection, then the first eight bytes or last eight bytes of the metadata is used for protection information (specified as part of the NVM Format operation).

4.6 Completion Queue Entry

An entry in the Completion Queue is 16 bytes in size. Figure 25 describes the layout of the Completion Queue Entry data structure. The contents of Dword 0 is command specific. If a command uses Dword 0, then the definition of this Dword is contained within the associated command definition. If a command does not use Dword 0, then the field is reserved. Dword 1 is reserved. Dword 2 is defined in Figure 26 and Dword 3 is defined in Figure 27. Any additional I/O Command Set defined in the future may use an alternate Completion Queue entry size or format.

Figure 25: Completion Queue Entry Layout – Admin and NVM Command Set

	31	23	15	7	0
DW0	Command Specific				
DW1	Reserved				
DW2	SQ Identifier		SQ Head Pointer		
DW3	Status Field		P	Command Identifier	

Figure 26: Completion Queue Entry: DW 2

Bit	Description
31:16	SQ Identifier (SQID): Indicates the Submission Queue to which the associated command was issued to. This field is used by host software when more than one Submission Queue shares a single Completion Queue to uniquely determine the command completed in combination with the Command Identifier (CID).
15:00	SQ Head Pointer (SQHD): Indicates the current Submission Queue Head pointer for the Submission Queue indicated in the SQ Identifier field. This is used to indicate to the host the Submission Queue entries that have been consumed and may be re-used for new entries. Note: The value returned is the value of the SQ Head pointer when the completion queue entry was created. By the time host software consumes the completion queue entry, the controller may have an SQ Head pointer that has advanced beyond the value indicated.

Figure 27: Completion Queue Entry: DW 3

Bit	Description
31:17	Status Field (SF): Indicates status for the command that is being completed. Refer to section 4.6.1.
16	Phase Tag (P): Identifies whether a Completion Queue entry is new. The Phase Tag values for all Completion Queue entries shall be initialized to '0' by host software prior to setting CC.EN to '1'. When the controller places an entry in the Completion Queue, it shall invert the phase tag to enable host software to discriminate a new entry. Specifically, for the first set of completion queue entries after CC.EN is set to '1' all Phase Tags are set to '1' when they are posted. For the second set of completion queue entries, when the controller has wrapped around to the top of the Completion Queue, all Phase Tags are cleared to '0' when they are posted. The value of the Phase Tag is inverted each pass through the Completion Queue.
15:00	Command Identifier (CID): Indicates the identifier of the command that is being completed. This identifier is assigned by host software when the command is submitted to the Submission Queue. The combination of the SQ Identifier and Command Identifier uniquely identifies the command that is being completed. The maximum number of requests outstanding at one time is 64K for an I/O Submission Queue and 4K for the Admin Submission Queue.

4.6.1 Status Field Definition

The Status Field defines the status for the command indicated in the completion queue entry, defined in Figure 28.

A value of 0h for the Status Field indicates a successful command completion, with no fatal or non-fatal error conditions.

Figure 28: Completion Queue Entry: Status Field

Bit	Description
31	Do Not Retry (DNR): If set to '1', indicates that if the same command is re-submitted it is expected to fail. If cleared to '0', indicates that the same command may succeed if retried. If a command is aborted due to time limited error recovery (refer to section 5.12.1.5), this field should be cleared to '0'.
30	More (M): If set to '1', there is more status information for this command as part of the Error Information log that may be retrieved with the Get Log Page command. If cleared to '0', there is no additional status information for this command. Refer to section 5.10.1.1.
29:28	Reserved
27:25	Status Code Type (SCT): Indicates the status code type of the completion queue entry. This indicates the type of status the controller is returning.
24:17	Status Code (SC): Indicates a status code identifying any error or status information for the command indicated.

4.6.1.1 Status Code Type (SCT)

Completion queue entries indicate a status code type for the type of completion being reported. Figure 29 specifies the status code type values and descriptions.

Figure 29: Status Code – Status Code Type Values

Value	Description
0h	Generic Command Status: Indicates that the command specified by the Command and Submission Queue identifiers in the completion queue entry has completed. These status values are generic across all command types, and include such conditions as success, opcode not supported, and invalid field.
1h	Command Specific Status: Indicates a status value that is specific to a particular command opcode. These values may indicate additional processing is required. Status values such as invalid firmware image or exceeded maximum number of queues is reported with this type.
2h	Media Errors: Any media specific errors that occur in the NVM or data integrity type errors shall be of this type.
3h – 6h	Reserved
7h	Vendor Specific

4.6.1.2 Status Code (SC)

The Status Code (SC) field in the completion queue entry indicates more detailed status information about the completion being reported.

Each Status Code set of values is split into three ranges:

- 00h – 7Fh: Applicable to Admin Command Set, or across multiple command sets.
- 80h – BFh: I/O Command Set Specific status codes.
- C0h – FFh: Vendor Specific status codes.

If there are multiple status codes that apply to a particular command failure, the controller shall report the status code with the lowest numerical value.

4.6.1.2.1 Generic Command Status Definition

Completion queue entries with a Status Code type of Generic Command Status indicate a status value associated with the command that is generic across many different types of commands.

Figure 30: Status Code – Generic Command Status Values

Value	Description
00h	Successful Completion: The command completed successfully.
01h	Invalid Command Opcode: The associated command opcode field is not valid.
02h	Invalid Field in Command: An invalid field specified in the command parameters.
03h	Command ID Conflict: The command identifier is already in use. Note: It is implementation specific how many commands are searched for a conflict.
04h	Data Transfer Error: Transferring the data or metadata associated with a command had an error.
05h	Commands Aborted due to Power Loss Notification: Indicates that the command was aborted due to a power loss notification.
06h	Internal Device Error: The command was not completed successfully due to an internal device error. Details on the internal device error are returned as an asynchronous event. Refer to section 5.2.
07h	Command Abort Requested: The command was aborted due to a Command Abort command being received that specified the Submission Queue Identifier and Command Identifier of this command.
08h	Command Aborted due to SQ Deletion: The command was aborted due to a Delete I/O Submission Queue request received for the Submission Queue to which the command was submitted.
09h	Command Aborted due to Failed Fused Command: The command was aborted due to the other command in a fused operation failing.
0Ah	Command Aborted due to Missing Fused Command: The command was aborted due to the companion fused command not being found as the subsequent Submission Queue entry.

0Bh	Invalid Namespace or Format: The namespace or the format of that namespace is invalid.
0Ch	Command Sequence Error: The command was aborted due to a protocol violation in a multi-command sequence (e.g. a violation of the Security Send and Security Receive sequencing rules in the TCG Storage Synchronous Interface Communications protocol).
0Dh	Invalid SGL Last Segment Descriptor: The command includes an invalid SGL Last Segment. This may occur when the SGL segment pointed to by an SGL Last Segment descriptor contains an SGL Segment descriptor or an SGL Last Segment descriptor. This may occur when an SGL Last Segment descriptor contains an invalid length (i.e., a length of zero or one that is not a multiple of 16).
0Eh	Invalid Number of SGL Descriptors: The number of SGL Segment descriptors or SGL Last Segment descriptors in a SGL segment is greater than one.
0Fh	Data SGL Length Invalid: The length of a Data SGL is too short or too long.
10h	Metadata SGL Length Invalid: The length of a Metadata SGL is too short or too long.
11h	SGL Descriptor Type Invalid: The type of an SGL Descriptor is a type that is not supported by the controller.
12h – 7Fh	Reserved
80h – BFh	I/O Command Set Specific
C0h – FFh	Vendor Specific

Figure 31: Status Code – Generic Command Status Values, NVM Command Set

Value	Description
80h	LBA Out of Range: The command references an LBA that exceeds the size of the namespace.
81h	Capacity Exceeded: Execution of the command has caused the capacity of the namespace to be exceeded. This error occurs when the Namespace Utilization exceeds the Namespace Capacity, as reported in Figure 84.
82h	Namespace Not Ready: The namespace is not ready to be accessed. The Do Not Retry bit indicates whether re-issuing the command at a later time may succeed.
83h	Reservation Conflict: The command was aborted due to a conflict with a reservation held on the accessed namespace. Refer to section 8.8.
84h – BFh	Reserved

4.6.1.2.2 Command Specific Errors Definition

Completion queue entries with a Status Code Type of Command Specific Errors indicate an error that is specific to a particular command opcode. Status codes of 0h to 7Fh are for Admin command errors. Status codes of 80h – BFh are specific to the selected I/O command set.

Figure 32: Status Code – Command Specific Status Values

Value	Description	Commands Affected
00h	Completion Queue Invalid	Create I/O Submission Queue
01h	Invalid Queue Identifier	Create I/O Submission Queue, Create I/O Completion Queue, Delete I/O Completion Queue, Delete I/O Submission Queue
02h	Maximum Queue Size Exceeded	Create I/O Submission Queue, Create I/O Completion Queue
03h	Abort Command Limit Exceeded	Abort
04h	Reserved	Reserved
05h	Asynchronous Event Request Limit Exceeded	Asynchronous Event Request
06h	Invalid Firmware Slot	Firmware Activate
07h	Invalid Firmware Image	Firmware Activate
08h	Invalid Interrupt Vector	Create I/O Completion Queue
09h	Invalid Log Page	Get Log Page
0Ah	Invalid Format	Format NVM
0Bh	Firmware Application Requires Conventional Reset	Firmware Activate
0Ch	Invalid Queue Deletion	Delete I/O Completion Queue
0Dh	Feature Identifier Not Saveable	Set Features
0Eh	Feature Not Changeable	Set Features
0Fh	Feature Not Namespace Specific	Set Features
10h	Firmware Application Requires NVM Subsystem Reset	Firmware Activate
11h – 7Fh	Reserved	
80h - BFh	I/O Command Set Specific	
C0 - FFh	Vendor Specific	

Figure 33: Status Code – Command Specific Status Values, NVM Command Set

Value	Description	Commands Affected
80h	Conflicting Attributes	Dataset Management, Read, Write
81h	Invalid Protection Information	Compare, Read, Write
82h	Attempted Write to Read Only Range	Write
83h - BFh	Reserved	

4.6.1.2.3 Media Errors Definition

Completion queue entries with a Status Code Type of Media Errors indicate an error associated with the command that is due to an error associated with the NVM media.

Figure 34: Status Code – Media Errors Values

Value	Description
00h – 7Fh	Reserved
80h – BFh	I/O Command Set Specific
C0h – FFh	Vendor Specific

Figure 35: Status Code – Media Errors Values, NVM Command Set

Value	Description
80h	Write Fault: The write data could not be committed to the media. This may be due to the lack of available spare locations that may be reported as an asynchronous event.
81h	Unrecovered Read Error: The read data could not be recovered from the media.
82h	End-to-end Guard Check Error: The command was aborted due to an end-to-end guard check failure.
83h	End-to-end Application Tag Check Error: The command was aborted due to an end-to-end application tag check failure.
84h	End-to-end Reference Tag Check Error: The command was aborted due to an end-to-end reference tag check failure.
85h	Compare Failure: The command failed due to a miscompare during a Compare command.
86h	Access Denied: Access to the namespace and/or LBA range is denied due to lack of access rights. Refer to TCG SIIS.
87h – BFh	Reserved

4.7 Fused Operations

Fused operations enable a more complex command by “fusing” together two simpler commands. This feature is optional; support for this feature is indicated in the Identify Controller data structure in Figure 82. In a fused operation, the requirements are:

- The commands shall be executed in sequence as an atomic unit. The controller shall behave as if no other operations have been executed between these two commands.
- The operation ends at the point an error is encountered in either command. If the first command in the sequence failed, then the second command shall be aborted. If the second command in the sequence failed, then the completion status of the first command is sequence specific.
- The LBA range, if used, shall be the same for the two commands. If the LBA ranges do not match, the commands should be aborted with status of Invalid Field in Command.
- The commands shall be inserted next to each other in the same Submission Queue. If the first command is the last entry in the Submission Queue, then the second command shall be the first entry in the Submission Queue as part of wrapping around. The Submission Queue Tail doorbell pointer update shall indicate both commands as part of one doorbell update.
- If the host desires to abort the fused operation, the host shall submit an Abort command separately for each of the commands.
- A completion queue entry is posted by the controller for each of the commands.

Whether a command is part of a fused operation is indicated in the Fused Operation field of Command Dword 0 in Figure 10. The Fused Operation field also indicates whether this is the first or second command in the operation.

4.8 Command Arbitration

A command is submitted when a Submission Queue Tail Doorbell write moves the Submission Queue Tail Pointer past the corresponding Submission Queue entry. The controller transfers submitted commands to the controller’s local memory for subsequent processing using a vendor specific algorithm.

A command is being processed when the controller and/or namespace state is being accessed or modified by the command (e.g., a Feature setting is being accessed or modified or a logical block is being accessed or modified).

A command is complete when a Completion Queue entry for the command has been posted to the corresponding Completion Queue. Upon completion, all controller state and/or namespace state modifications made by that command are globally visible to all subsequently submitted commands.

A candidate command is a submitted command the controller deems ready for processing. The controller selects command(s) for processing from the pool of submitted commands for each Submission Queue. The commands that comprise a fused operation shall be processed together and in order by the controller. The controller may select candidate commands for processing in any order. The order in which commands are selected for processing does not imply the order in which commands are completed.

Arbitration is the method used to determine the Submission Queue from which the controller will start processing the next candidate command(s). Once a Submission Queue is selected using arbitration, the Arbitration Burst setting determines the maximum number of commands that the controller may start processing from that Submission Queue before arbitration shall again take place. A fused operation may be considered as one or two commands by the controller.

All controllers shall support the round robin command arbitration mechanism. A controller may optionally implement weighted round robin with urgent priority class and/or a vendor specific arbitration mechanism. The Arbitration Mechanism Supported field in the Controller Capabilities register (CC.AMS) indicates optional arbitration mechanisms supported by the controller.

In order to make efficient use of the non-volatile memory, it is often advantageous to execute multiple commands from a Submission Queue in parallel. For Submission Queues that are using weighted round robin with urgent priority class or round robin arbitration, host software may configure an Arbitration Burst setting. The Arbitration Burst setting indicates the maximum number of commands that the controller may launch at one time from a particular Submission Queue. It is recommended that host software configure the Arbitration Burst setting as close to the recommended value by the controller as possible (specified in the Recommended Arbitration Burst field of the Identify Controller data structure in Figure 82), taking into consideration any latency requirements. Refer to section 5.12.1.1.

4.8.1 Round Robin Arbitration

If the round robin arbitration mechanism is selected, the controller shall implement round robin command arbitration amongst all Submission Queues, including the Admin Submission Queue. In this case, all Submission Queues are treated with equal priority. The controller may select multiple candidate commands for processing from each Submission Queue per round based on the Arbitration Burst setting.

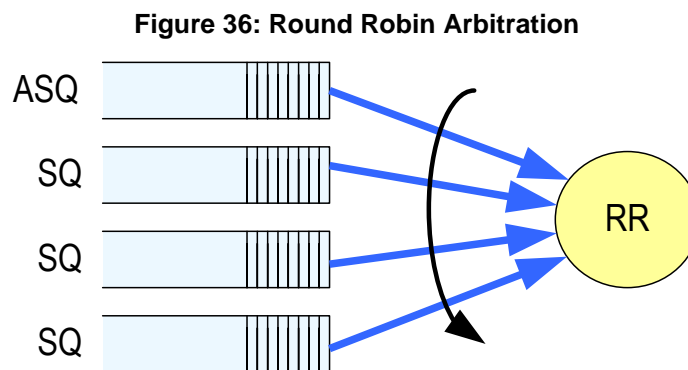

4.8.2 Weighted Round Robin with Urgent Priority Class Arbitration

In this arbitration mechanism, there are three strict priority classes and three weighted round robin priority levels. If Submission Queue A is of higher strict priority than Submission Queue B, then all candidate commands in Submission Queue A shall start processing before candidate commands from Submission Queue B start processing.

The highest strict priority class is the Admin class that includes any command submitted to the Admin Submission Queue. This class has the highest strict priority above commands submitted to any other Submission Queue.

The next highest strict priority class is the Urgent class. Any I/O Submission Queue assigned to the Urgent priority class is serviced next after commands submitted to the Admin Submission Queue, and before any commands submitted to a weighted round robin priority level. Host software should use care in assigning any Submission Queue to the Urgent priority class since there is the potential to starve I/O Submission Queues in the weighted round robin priority levels as there is no fairness protocol between Urgent and non Urgent I/O Submission Queues.

The lowest strict priority class is the Weighed Round Robin class. This class consists of the three weighted round robin priority levels (High, Medium, and Low) that share the remaining bandwidth using weighted round robin arbitration. Host software controls the weights for the High, Medium, and Low service classes via Set Features. Round robin is used to arbitrate within multiple Submission Queues assigned to the same weighted round robin level. The number of candidate commands that may start processing from each Submission Queue per round is either the Arbitration Burst setting or the remaining weighted round robin credits, whichever is smaller.

Figure 37: Weighted Round Robin with Urgent Priority Class Arbitration

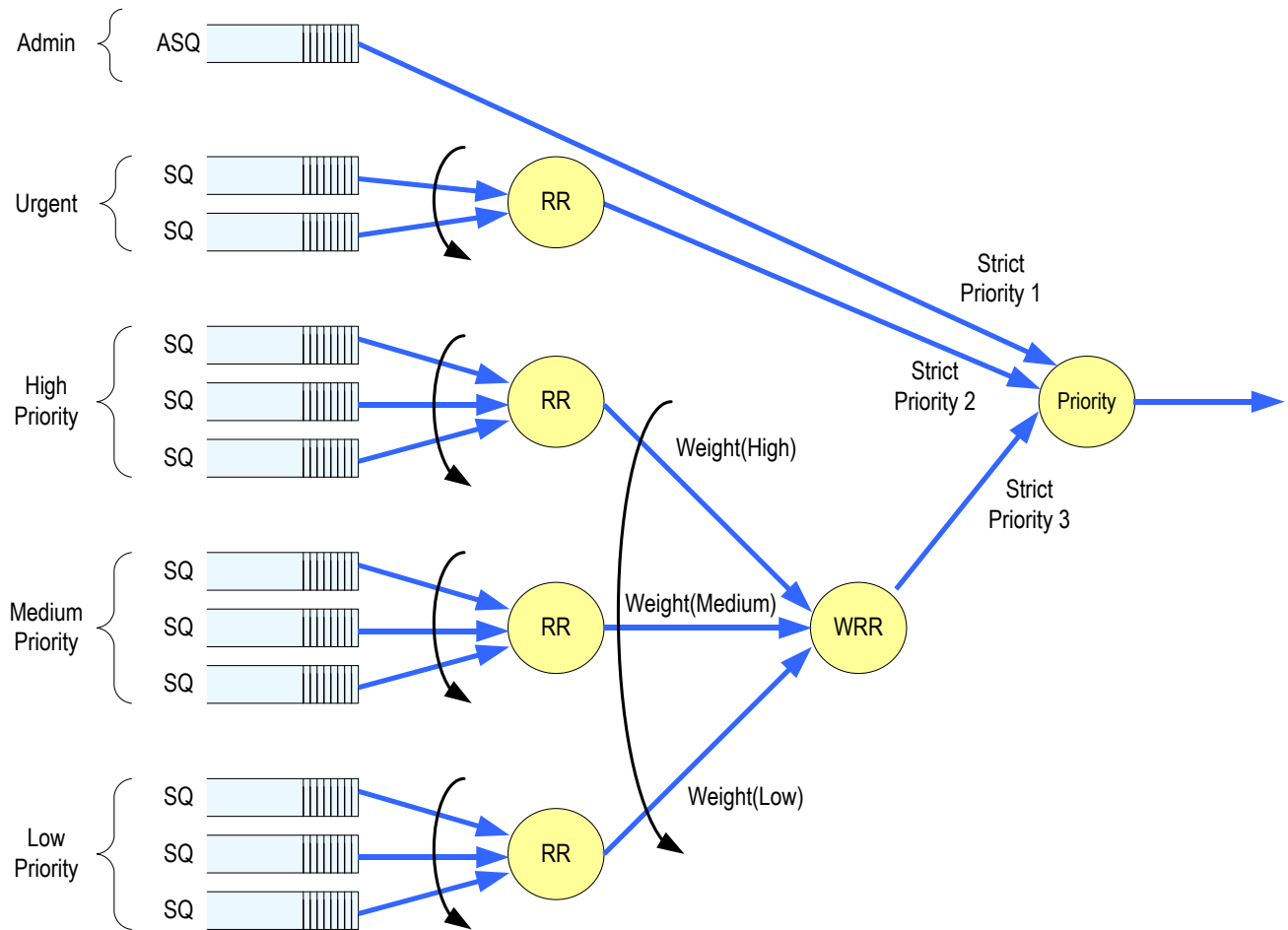

In Figure 37, the Priority decision point selects the highest priority candidate command selected next to start processing.

4.8.3 Vendor Specific Arbitration

A vendor may choose to implement a vendor specific arbitration mechanism. The mechanism(s) are outside the scope of this specification.

5 Admin Command Set

The Admin Command Set defines the commands that may be submitted to the Admin Submission Queue.

The Submission Queue Entry (SQE) structure and the fields that are common to all Admin commands are defined in section 4.2. The Completion Queue Entry (CQE) structure and the fields that are common to all Admin commands are defined in section 4.6. The command specific fields in the SQE and CQE structures for the Admin Command Set are defined in this section.

For all Admin commands, Dword 14 and 15 are I/O Command Set specific.

Figure 38: Opcodes for Admin Commands

Opcode (07)	Opcode (06:02)	Opcode (01:00)	Opcode	O/M	Namespace Identifier Used ³	Command
Generic Command	Function	Data Transfer				
0b	000 00b	00b	00h	M	No	Delete I/O Submission Queue
0b	000 00b	01b	01h	M	No	Create I/O Submission Queue
0b	000 00b	10b	02h	M	Yes	Get Log Page
0b	000 01b	00b	04h	M	No	Delete I/O Completion Queue
0b	000 01b	01b	05h	M	No	Create I/O Completion Queue
0b	000 01b	10b	06h	M	Yes	Identify
0b	000 10b	00b	08h	M	No	Abort
0b	000 10b	01b	09h	M	Yes	Set Features
0b	000 10b	10b	0Ah	M	Yes	Get Features
0b	000 11b	00b	0Ch	M	No	Asynchronous Event Request
0b	001 00b	00b	10h	O	No	Firmware Activate
0b	001 00b	01b	11h	O	No	Firmware Image Download
I/O Command Set Specific						
1b	na	na	80h – BFh	O		I/O Command Set specific
Vendor Specific						
1b	na	na	C0h – FFh	O		Vendor specific
NOTES:						
1. O/M definition: O = Optional, M = Mandatory.						
2. Opcodes not listed are reserved.						
3. A subset of commands uses the Namespace Identifier field (CDW1.NSID). When not used, the field shall be cleared to 0h. For the Get Features and Set Features command, refer to section 7.7 for details on how the Namespace Identifier is used. For the Identify command, the Namespace Identifier is only used for the Namespace data structure. For the Get Log Page command, a value of FFFFFFFFh is used to specify that the global values should be returned.						

Figure 39 defines Admin commands that are specific to the NVM Command Set.

Figure 39: Opcodes for Admin Commands – NVM Command Set Specific

Opcode (07)	Opcode (06:02)	Opcode (01:00)	Opcode	O/M	Namespace Identifier Used ³	Command
Generic Command	Function	Data Transfer				
1b	000 00b	00b	80h	O	Yes	Format NVM
1b	000 00b	01b	81h	O	Yes	Security Send
1b	000 00b	10b	82h	O	Yes	Security Receive

NOTES:

- O/M definition: O = Optional, M = Mandatory.
- Opcodes not listed are reserved.
- A subset of commands uses the Namespace Identifier field (CDW1.NSID). When not used, the field shall be cleared to 0h.

5.1 Abort command

The Abort command is used to abort a specific command previously submitted to the Admin Submission Queue or an I/O Submission Queue. Host software may have multiple Abort commands outstanding, subject to the constraints of the Abort Command Limit indicated in the Identify Controller data structure in Figure 82. An Abort command is a best effort command; the command to abort may have already completed, currently be in execution, or may be deeply queued. It is implementation specific if/when a controller chooses to complete the command when the command to abort is not found.

The Abort command uses the Command Dword 10 field. All other command specific fields are reserved.

Figure 40: Abort – Command Dword 10

Bit	Description
31:16	Command Identifier (CID): This field specifies the command identifier of the command to be aborted, that was specified in the CDW0.CID field within the command itself.
15:00	Submission Queue Identifier (SQID): This field specifies the identifier of the Submission Queue that the command to be aborted is associated with.

5.1.1 Command Completion

A completion queue entry is posted to the Admin Completion Queue if the command has been completed and a corresponding completion queue entry has been posted to the appropriate Admin or I/O Completion Queue. Dword 0 of the completion queue entry indicates whether the command was aborted. If the command was successfully aborted, then bit 0 of Dword 0 is cleared to '0'. If the command was not aborted, then bit 0 of Dword 0 is set to '1'.

Command specific status values associated with the Abort command are defined in Figure 41.

Figure 41: Abort – Command Specific Status Values

Value	Description
3h	Abort Command Limit Exceeded: The number of concurrently outstanding Abort commands has exceeded the limit indicated in the Identify Controller data structure.

5.2 Asynchronous Event Request command

Asynchronous events are used to notify host software of status, error, and health information as these events occur. To enable asynchronous events to be reported by the controller, host software needs to submit one or more Asynchronous Event Request commands to the controller. The controller specifies an event to the host by completing an Asynchronous Event Request command. Host software should expect that the controller may not execute the command immediately; the command should be completed when there is an event to be reported.

The Asynchronous Event Request command is submitted by host software to enable the reporting of asynchronous events from the controller. This command has no timeout. The controller posts a completion queue entry for this command when there is an asynchronous event to report to the host. If Asynchronous Event Request commands are outstanding when the controller is reset, the commands are aborted.

All command specific fields are reserved.

Host software may submit multiple Asynchronous Event Request commands to reduce event reporting latency. The total number of simultaneously outstanding Asynchronous Event Request commands is limited by the Asynchronous Event Request Limit specified in the Identify Controller data structure in Figure 82.

Asynchronous events are grouped into event types. The event type information is indicated in Dword 0 of the completion queue entry for the Asynchronous Event Request command. When the controller posts a completion queue entry for an outstanding Asynchronous Event Request command and thus reports an asynchronous event, subsequent events of that event type are automatically masked by the controller until the host clears that event. An event is cleared by reading the log page associated with that event using the Get Log Page command (see section 5.10).

The following event types are defined:

- Error event: Indicates a general error that is not associated with a specific command. To clear this event, host software reads the Error Information log using the Get Log Page command.
- SMART / Health Status event: Indicates a SMART or health status event. To clear this event, host software reads the SMART / Health Information log using Get Log Page. The SMART / Health conditions that trigger asynchronous events may be configured in the Asynchronous Event Configuration feature using the Set Features command (see section 5.12).
- I/O Command Set events: Events that are defined by an I/O command set.
 - NVM Command Set Events:
 - Reservation Log Page Available event: Indicates that one or more Reservation Notification log pages are available.
- Vendor Specific event: Indicates a vendor specific event. To clear this event, host software reads the indicated vendor specific log page using Get Log Page.

When the controller needs to report an event and there are no outstanding Asynchronous Event Request commands, the controller queues the event internal to the controller and reports it when an Asynchronous Event Request command is received.

5.2.1 Command Completion

A completion queue entry is posted to the Admin Completion Queue if there is an asynchronous event to report to the host. Command specific status values associated with Asynchronous Event Request are defined in Figure 42.

Figure 42: Status Code – Command Specific Status Values

Value	Description
5h	Asynchronous Event Request Limit Exceeded: The number of concurrently outstanding Asynchronous Event Request commands has been exceeded.

Dword 0 of the completion queue entry contains information about the asynchronous event. The definition of Dword 0 of the completion queue entry is in Figure 43.

Figure 43: Asynchronous Event Request – Completion Queue Entry Dword 0

Bit	Description		
31:24	Reserved		
23:16	Associated Log Page: Indicates the log page associated with the asynchronous event. This log page needs to be read by the host to clear the event.		
15:08	Asynchronous Event Information: Refer to Figure 44 and Figure 45 for detailed information regarding the asynchronous event.		
07:03	Reserved		
02:00	Asynchronous Event Type: Indicates the type of the asynchronous event. More specific information on the event is provided in the Asynchronous Event Information field.		
		Value	Definition
		0h	Error status
		1h	SMART / Health status
		2h – 5h	Reserved
		6h	I/O Command Set specific status
7h	Vendor specific		

The information in either Figure 44, Figure 45, or Figure 46 is returned in the Asynchronous Event Information field, depending on the Asynchronous Event Type.

Figure 44: Asynchronous Event Information – Error Status

Value	Description
0h	Invalid Submission Queue: Host software wrote the doorbell of a queue that was not created.
1h	Invalid Doorbell Write Value: Host software attempted to write an invalid doorbell value. Some possible causes of this error are: <ul style="list-style-type: none"> the value written was out of range of the corresponding queue's base address and size, the value written is the same as the previously written doorbell value, host software attempts to add a command to a full Submission Queue, and host software attempts to remove a completion queue entry from an empty Completion Queue.
2h	Diagnostic Failure: A diagnostic failure was detected. This may include a self test operation.
3h	Persistent Internal Device Error: A failure occurred within the device that is persistent or the device is unable to isolate to a specific set of commands. If this error is indicated, then the CSTS.CFS bit may be set to '1' and the host should perform a reset as described in section 7.3.
4h	Transient Internal Device Error: A transient error occurred within the device that is specific to a particular set of commands and operation may continue.
5h	Firmware Image Load Error: The firmware image could not be loaded. The controller reverted to the previously active firmware image or a baseline read-only firmware image.
6h - FFh	Reserved

Figure 45: Asynchronous Event Information – SMART / Health Status

Value	Description
0h	Device Reliability: Device reliability has been compromised. This may be due to significant media errors, an internal error, the media being placed in read only mode, or a volatile memory backup device failing.
1h	Temperature Above Threshold: Temperature is above the temperature threshold.
2h	Spare Below Threshold: Available spare space has fallen below the threshold.
3h - FFh	Reserved

Figure 46: Asynchronous Event Information – NVM Command Set Specific Status

Value	Description
0h	Reservation Log Page Available: Indicates that one or more Reservation Notification log pages are available.
1h - FFh	Reserved

5.3 Create I/O Completion Queue command

The Create I/O Completion Queue command is used to create all I/O Completion Queues with the exception of the Admin Completion Queue. The Admin Completion Queue is created by specifying its base address in the ACQ register. If a PRP List is provided to describe the CQ, then the PRP List shall be maintained by host software at the same location in host physical memory and the values in the PRP List shall not be modified until the corresponding Delete I/O Completion Queue command for this CQ is completed successfully or the controller is reset. If the PRP List values are modified, the behavior is undefined.

The Create I/O Completion Queue command uses the PRP Entry 1, Command Dword 10, and Command Dword 11 fields. All other command specific fields are reserved.

Figure 47: Create I/O Completion Queue – PRP Entry 1

Bit	Description
63:00	PRP Entry 1 (PRP1): If CDW11.PC is set to '1', then this field specifies a 64-bit base memory address pointer of the Completion Queue that is physically contiguous and is memory page aligned (based on the value in CC.MPS). If CDW11.PC is cleared to '0', then this field specifies a PRP List pointer that describes the list of pages that constitute the Completion Queue and is memory page aligned (based on the value in CC.MPS). In both cases the PRP Entry shall have an offset of 0h. In a non-contiguous Completion Queue, each PRP Entry in the PRP List shall have an offset of 0h.

Figure 48: Create I/O Completion Queue – Command Dword 10

Bit	Description
31:16	Queue Size (QSIZE): This field indicates the size of the Completion Queue to be created. Refer to section 4.1.3. This is a 0's based value.
15:00	Queue Identifier (QID): This field indicates the identifier to assign to the Completion Queue to be created. This identifier corresponds to the Completion Queue Head Doorbell used for this command (i.e., the value y in section 3.1.12). This value shall not exceed the value reported in the Number of Queues feature (see section 5.12.1.7) for I/O Completion Queues.

Figure 49: Create I/O Completion Queue – Command Dword 11

Bit	Description
31:16	Interrupt Vector (IV): This field indicates interrupt vector to use for this Completion Queue. This corresponds to the MSI-X or multiple message MSI vector to use. If using single message MSI or pin-based interrupts, then this field shall be cleared to 0h. In MSI-X, a maximum of 2K vectors are used. This value shall not be set to a value greater than the number of messages the controller supports (refer to MSICAP.MC.MME or MSIXCAP.MXC.TS).
15:02	Reserved
01	Interrupts Enabled (IEN): If set to '1', then interrupts are enabled for this Completion Queue. If cleared to '0', then interrupts are disabled for this Completion Queue.
00	Physically Contiguous (PC): If set to '1', then the Completion Queue is physically contiguous and PRP Entry 1 (PRP1) is the address of a contiguous physical buffer. If cleared to '0', then the Completion Queue is not physically contiguous and PRP Entry 1 (PRP1) is a PRP List pointer.

5.3.1 Command Completion

If the command is completed, then the controller shall post a completion queue entry to the Admin Completion Queue indicating the status for the command.

Create I/O Completion Queue command specific status values are defined in Figure 50.

Figure 50: Create I/O Completion Queue – Command Specific Status Values

Value	Description
1h	Invalid Queue Identifier: The creation of the I/O Completion Queue failed due to an invalid queue identifier specified as part of the command.
2h	Maximum Queue Size Exceeded: The host attempted to create an I/O Completion Queue with a number of entries that exceeds the maximum supported by the controller, specified in CAP.MQES.
8h	Invalid Interrupt Vector: The creation of the I/O Completion Queue failed due to an invalid interrupt vector specified as part of the command.

5.4 Create I/O Submission Queue command

The Create I/O Submission Queue command is used to create I/O Submission Queues. The Admin Submission Queue is created by specifying its base address in the ASQ register. If a PRP List is provided to describe the SQ, then the PRP List shall be maintained by host software at the same location in host physical memory and the values in the PRP List shall not be modified until the corresponding Delete I/O Submission Queue command for this SQ is completed or the controller is reset. If the PRP List values are modified, the behavior is undefined.

The Create I/O Submission Queue command uses the PRP Entry 1, Command Dword 10, and Command Dword 11 fields. All other command specific fields are reserved.

Figure 51: Create I/O Submission Queue – PRP Entry 1

Bit	Description
63:00	PRP Entry 1 (PRP1): If CDW11.PC is set to '1', then this field specifies a 64-bit base memory address pointer of the Submission Queue that is physically contiguous and is memory page aligned (based on the value in CC.MPS). If CDW11.PC is cleared to '0', then this field specifies a PRP List pointer that describes the list of pages that constitute the Submission Queue and is memory page aligned (based on the value in CC.MPS). In both cases, the PRP Entry shall have an offset of 0h. In a non-contiguous Submission Queue, each PRP Entry in the PRP List shall have an offset of 0h.

Figure 52: Create I/O Submission Queue – Command Dword 10

Bit	Description
31:16	Queue Size (QSIZE): This field indicates the size of the Submission Queue to be created. Refer to section 4.1.3. This is a 0's based value.
15:00	Queue Identifier (QID): This field indicates the identifier to assign to the Submission Queue to be created. This identifier corresponds to the Submission Queue Tail Doorbell used for this command (i.e., the value y in section 3.1.11). This value shall not exceed the value reported in the Number of Queues feature (see section 5.12.1.7) for I/O Submission Queues.

Figure 53: Create I/O Submission Queue – Command Dword 11

Bit	Description										
31:16	Completion Queue Identifier (CQID): This field indicates the identifier of the Completion Queue to utilize for any command completions entries associated with this Submission Queue. The value of 0h (Admin Completion Queue) shall not be specified.										
15:03	Reserved										
02:01	<p>Queue Priority (QPRIO): This field indicates the priority service class to use for commands within this Submission Queue. This field is only used when the weighted round robin with an urgent priority service class is the arbitration mechanism is selected, the field is ignored if weighted round robin with an urgent priority service class is not used. Refer to section 4.8.</p> <table border="1"> <thead> <tr> <th>Value</th> <th>Definition</th> </tr> </thead> <tbody> <tr> <td>00b</td> <td>Urgent</td> </tr> <tr> <td>01b</td> <td>High</td> </tr> <tr> <td>10b</td> <td>Medium</td> </tr> <tr> <td>11b</td> <td>Low</td> </tr> </tbody> </table>	Value	Definition	00b	Urgent	01b	High	10b	Medium	11b	Low
Value	Definition										
00b	Urgent										
01b	High										
10b	Medium										
11b	Low										
00	Physically Contiguous (PC): If set to '1', then the Submission Queue is physically contiguous and PRP Entry 1 (PRP1) is the address of a contiguous physical buffer. If cleared to '0', then the Submission Queue is not physically contiguous and PRP Entry 1 (PRP1) is a PRP List pointer.										

5.4.1 Command Completion

When the command is completed, the controller posts a completion queue entry to the Admin Completion Queue indicating the status for the command.

Create I/O Submission Queue command specific status values are defined in Figure 54.

Figure 54: Create I/O Submission Queue – Command Specific Status Values

Value	Description
0h	Completion Queue Invalid: The Completion Queue identifier specified in the command does not exist.
1h	Invalid Queue Identifier: The creation of the I/O Submission Queue failed due an invalid queue identifier specified as part of the command.
2h	Maximum Queue Size Exceeded: Host software attempted to create an I/O Submission Queue with a number of entries that exceeds the maximum supported by the controller, specified in CAP.MQES.

5.5 Delete I/O Completion Queue command

The Delete I/O Completion Queue command is used to delete an I/O Completion Queue. The Delete I/O Completion Queue command uses the Command Dword 10 field. All other command specific fields are reserved. After this command has completed, the PRP List that describes the Completion Queue may be deallocated by host software.

Host software shall ensure that any associated I/O Submission Queue is deleted prior to deleting a Completion Queue. If there are any associated I/O Submission Queues present, then the Delete I/O Completion Queue command shall fail with a status value of Invalid Queue Deletion.

Note: It is not possible to delete the Admin Completion Queue.

Figure 55: Delete I/O Completion Queue – Command Dword 10

Bit	Description
31:16	Reserved
15:00	Queue Identifier (QID): This field indicates the identifier of the Completion Queue to be deleted. The value of 0h (Admin Completion Queue) shall not be specified.

5.5.1 Command Completion

A completion queue entry is posted to the Admin Completion Queue when the indicated I/O Completion Queue has been deleted. Delete I/O Completion Queue command specific status values are defined in Figure 56.

Figure 56: Delete I/O Completion Queue – Command Specific Status Values

Value	Description
1h	Invalid Queue Identifier: The Queue Identifier specified in the command is invalid. This error is also indicated if the Admin Completion Queue identifier is specified.
0Ch	Invalid Queue Deletion: This error indicates that it is invalid to delete the I/O Completion Queue specified. The typical reason for this error condition is that there is an associated I/O Submission Queue that has not been deleted.

5.6 Delete I/O Submission Queue command

The Delete I/O Submission Queue command is used to delete an I/O Submission Queue. The Delete I/O Submission Queue command uses the Command Dword 10 field. All other command specific fields are reserved. After this command has completed, the PRP List that describes the Submission Queue may be deallocated by host software.

The command causes all commands submitted to the indicated Submission Queue that are still in progress to be aborted. The controller may post individual completion status of Command Aborted due to SQ Deletion for commands that have been aborted. Commands that are not able to be aborted should be completed with appropriate completion status.

Note: It is not possible to delete the Admin Submission Queue.

Figure 57: Delete I/O Submission Queue – Command Dword 10

Bit	Description
31:16	Reserved
15:00	Queue Identifier (QID): This field indicates the identifier of the Submission Queue to be deleted. The value of 0h (Admin Submission Queue) shall not be specified.

5.6.1 Command Completion

After all commands submitted to the indicated I/O Submission Queue are either completed or aborted, a completion queue entry is posted to the Admin Completion Queue when the queue has been deleted. Delete I/O Submission Queue command specific status values are defined in Figure 58.

Figure 58: Delete I/O Submission Queue – Command Specific Status Values

Value	Description
1h	Invalid Queue Identifier: The Queue Identifier specified in the command is invalid. This error is also indicated if the Admin Submission Queue identifier is specified.

5.7 Firmware Activate command

The Firmware Activate command is used to verify that a valid firmware image has been downloaded and to commit that revision to a specific firmware slot. The host may select the firmware image to activate on the next controller reset (CC.EN transitions from '1' to '0', a PCI function level reset, and/or other Controller or NVM Subsystem Reset) as part of this command. The currently executing firmware revision may be determined from the Firmware Revision field of the Identify Controller data structure in Figure 82 or as indicated in the Firmware Slot Information log page.

The Firmware Activate command uses the Command Dword 10 field. All other command specific fields are reserved.

Figure 59: Firmware Activate – Command Dword 10

Bit	Description											
31:05	Reserved											
04:03	Activate Action (AA): This field specifies the action that is taken on the image downloaded with the Firmware Image Download command or on a previously downloaded and placed image. The actions are indicated in the following table.											
		<table border="1"> <thead> <tr> <th>Value</th> <th>Definition</th> </tr> </thead> <tbody> <tr> <td>00b</td> <td>Downloaded image replaces the image indicated by the Firmware Slot field. This image is not activated.</td> </tr> <tr> <td>01b</td> <td>Downloaded image replaces the image indicated by the Firmware Slot field. This image is activated at the next reset.</td> </tr> <tr> <td>10b</td> <td>The image indicated by the Firmware Slot field is activated at the next reset.</td> </tr> <tr> <td>11b</td> <td>Reserved</td> </tr> </tbody> </table>	Value	Definition	00b	Downloaded image replaces the image indicated by the Firmware Slot field. This image is not activated.	01b	Downloaded image replaces the image indicated by the Firmware Slot field. This image is activated at the next reset.	10b	The image indicated by the Firmware Slot field is activated at the next reset.	11b	Reserved
		Value	Definition									
		00b	Downloaded image replaces the image indicated by the Firmware Slot field. This image is not activated.									
		01b	Downloaded image replaces the image indicated by the Firmware Slot field. This image is activated at the next reset.									
10b	The image indicated by the Firmware Slot field is activated at the next reset.											
11b	Reserved											
02:00	Firmware Slot (FS): Specifies the firmware slot that shall be used for the Activate Action, if applicable. If the value specified is 0h, then the controller shall choose the firmware slot (slot 1 – 7) to use for the operation.											

5.7.1 Command Completion

A completion queue entry is posted to the Admin Completion Queue if the controller has completed the requested action (specified in the Activate Action field). Firmware Activate command specific status values are defined in Figure 60.

Figure 60: Firmware Activate – Command Specific Status Values

Value	Description
6h	Invalid Firmware Slot: The firmware slot indicated is invalid or read only. This error is indicated if the firmware slot exceeds the number supported.
7h	Invalid Firmware Image: The firmware image specified for activation is invalid and not loaded by the controller.
0Bh	Firmware Application Requires Conventional Reset: The operation specified by the Activate Action field completed successfully. However, activation of the firmware image requires a conventional reset. If an FLR or controller reset occurs prior to a conventional reset, the controller shall continue operation with the currently executing firmware image.
0Ch	Firmware Application Requires NVM Subsystem Reset: The operation specified by the Activate Action field completed successfully. However, activation of the firmware image requires an NVM Subsystem Reset. If any other type of reset occurs prior to an NVM Subsystem Reset, the controller shall continue operation with the currently executing firmware image.

5.8 Firmware Image Download command

The Firmware Image Download command is used to download all or a portion of the firmware image for a future update to the controller. The Firmware Image Download command may be submitted while other commands on the Admin Submission Queue or I/O Submission Queues are outstanding. The Firmware Image Download command copies the new firmware image (in whole or in part) to the controller.

The firmware image may be constructed of multiple pieces that are individually downloaded with separate Firmware Image Download commands. Each Firmware Image Download command includes a Dword Offset and Number of Dwords that specify a Dword range. The host software shall ensure that firmware pieces do not have Dword ranges that overlap. Firmware portions may be submitted out of order to the controller.

The new firmware image is not applied as part of the Firmware Image Download command. It is applied following a reset, where the image to apply and the firmware slot it should be committed to is specified with the Firmware Activate command.

The Firmware Image Download command uses the PRP Entry 1, PRP Entry 2, Command Dword 10, and Command Dword 11 fields. All other command specific fields are reserved.

Figure 61: Firmware Image Download – PRP Entry 1

Bit	Description
63:00	PRP Entry 1 (PRP1): This field contains the first PRP entry, specifying the location where data should be transferred from.

Figure 62: Firmware Image Download – PRP Entry 2

Bit	Description
63:00	PRP Entry 2 (PRP2): This field contains the second PRP entry. If the data transfer is satisfied with PRP Entry 1, then this field is reserved. If the data transfer may be satisfied with two PRP entries total, then this entry specifies the location where data should be transferred from. If the data transfer requires more than two PRP entries, then this field contains a pointer to a PRP List.

Figure 63: Firmware Image Download – Command Dword 10

Bit	Description
31:00	Number of Dwords (NUMD): This field specifies the number of Dwords to transfer for this portion of the firmware. This is a 0's based value.

Figure 64: Firmware Image Download – Command Dword 11

Bit	Description
31:00	Offset (OFST): This field specifies the number of Dwords offset from the start of the firmware image being downloaded to the controller. The offset is used to construct the complete firmware image when the firmware is downloaded in multiple pieces. The piece corresponding to the start of the firmware image shall have an Offset of 0h.

5.8.1 Command Completion

A completion queue entry is posted to the Admin Completion Queue if this portion of the firmware image has been received by the controller.

5.9 Get Features command

The Get Features command retrieves the attributes of the Feature specified.

The Get Features command uses the PRP Entry 1, PRP Entry 2, Command Dword 10, and Command Dword 11 fields. All other command specific fields are reserved.

Figure 65: Get Features – PRP Entry 1

Bit	Description
63:00	PRP Entry 1 (PRP1): Specifies a data buffer that the Feature information shall be returned in if the Feature information is returned in a data structure. The buffer shall not have more than one physical discontinuity. If no data structure is used as part of the specified feature, then this field is ignored.

Figure 66: Get Features – PRP Entry 2

Bit	Description
63:00	PRP Entry 2 (PRP2): This field contains the second PRP entry that specifies the location where data should be transferred to (if there is a physical discontinuity). This field shall not be a pointer to a PRP List. If no data structure is used as part of the specified feature, then this field is ignored.

Figure 67: Get Features – Command Dword 10

Bit	Description												
31:11	Reserved												
10:08	<p>Select (SEL): This field specifies which value of the attributes to return in the provided data:</p> <table border="1" style="margin-left: auto; margin-right: auto;"> <thead> <tr> <th>Select</th> <th>Description</th> </tr> </thead> <tbody> <tr> <td>000b</td> <td>Current</td> </tr> <tr> <td>001b</td> <td>Default</td> </tr> <tr> <td>010b</td> <td>Saved</td> </tr> <tr> <td>011b</td> <td>Supported capabilities</td> </tr> <tr> <td>100b – 111b</td> <td>Reserved</td> </tr> </tbody> </table> <p>Refer to section 5.9.1 for details on the value returned in each case.</p> <p>The controller indicates in bit 4 of the Optional NVM Command Support field of the Identify Controller Data structure in Figure 82 whether this field is supported.</p> <p>If a Get Features command is received with the Select field set to 010b (i.e., saved) and the controller does not support the Feature Identifier being saved or does not currently have any saved values, then the controller shall treat the Select field as though it was set to 001b (i.e., default.)</p>	Select	Description	000b	Current	001b	Default	010b	Saved	011b	Supported capabilities	100b – 111b	Reserved
Select	Description												
000b	Current												
001b	Default												
010b	Saved												
011b	Supported capabilities												
100b – 111b	Reserved												
07:00	<p>Feature Identifier (FID): This field specifies the identifier of the Feature for which to provide data.</p>												

Figure 68 describes the Feature Identifiers whose attributes may be retrieved using Get Features. The definition of the attributes returned and associated format is specified in the section indicated.

Figure 68: Get Features – Feature Identifiers

Description	Section Defining Format of Attributes Returned
Arbitration	Section 5.12.1.1
Power Management	Section 5.12.1.2
LBA Range Type	Section 5.12.1.3
Temperature Threshold	Section 5.12.1.4
Error Recovery	Section 5.12.1.5
Volatile Write Cache	Section 5.12.1.6
Number of Queues	Section 5.12.1.7
Interrupt Coalescing	Section 5.12.1.8
Interrupt Vector Configuration	Section 5.12.1.9
Write Atomicity	Section 5.12.1.10
Asynchronous Event Configuration	Section 5.12.1.11
NVM Command Set Specific	
Software Progress Marker	Section 5.12.1.12
Host Identifier	Section 5.12.1.13
Registration Notification Mask	Section 5.12.1.14
Reservation Persistence	Section 5.12.1.15

5.9.1 Select field

A Select field set to 000b (i.e., current) returns the current operating attribute value for the Feature Identifier specified.

A Select field set to 001b (i.e., default) returns the default attribute value for the Feature Identifier specified.

A Select field set to 010b (i.e., saved) returns the last saved attribute value for the Feature Identifier specified (i.e., the last Set Features command completed without error, with the Save bit set to '1' for the Feature Identifier specified.)

A Select field set to 011b (i.e., supported capabilities) returns the capabilities supported for this Feature Identifier. The capabilities supported are returned in Dword 0 of the completion entry of the Get Features command.

- If Dword 0 bit 0 of the completion entry of the Get Features command is set to '1', then the Feature Identifier is saveable. If Dword 0 bit 0 of the completion entry of the Get Features command is cleared to '0', then the Feature Identifier is not saveable.
- If Dword 0 bit 1 of the completion entry of the Get Features command is set to '1', then the Feature Identifier is namespace specific and settings are applied to individual namespaces. If Dword 0 bit 1 of the completion entry of the Get Features command is cleared to '0', then the Feature Identifier is not namespace specific and its settings apply to the entire controller.
- If Dword 0 bit 2 of the completion entry of the Get Features command is set to '1', then the Feature Identifier is changeable. If Dword 0 bit 2 of the completion entry of the Get Features command is cleared to '0', then the Feature Identifier is not changeable.

5.9.2 Command Completion

A completion queue entry is posted to the Admin Completion Queue if the controller has completed returning any attributes associated with the Feature. Depending on the Feature Identifier, Dword 0 of the completion queue entry may contain feature information (refer to section 5.12.1).

5.10 Get Log Page command

The Get Log Page command returns a data buffer containing the log page requested.

The Get Log Page command uses the PRP Entry 1, PRP Entry 2, and Command Dword 10 fields. All other command specific fields are reserved.

Figure 69: Get Log Page – PRP Entry 1

Bit	Description
63:00	PRP Entry 1 (PRP1): Specifies a data buffer that the log page shall be returned to. The buffer shall not have more than one physical discontinuity.

Figure 70: Get Log Page – PRP Entry 2

Bit	Description
63:00	PRP Entry 2 (PRP2): This field contains the second PRP entry that specifies the location where data should be transferred to (if there is a physical discontinuity). This field shall not be a pointer to a PRP List.

Figure 71: Get Log Page – Command Dword 10

Bit	Description
31:28	Reserved
27:16	Number of Dwords (NUMD): This field specifies the number of Dwords to return. If host software specifies a size larger than the log page requested, the results are undefined. This is a 0's based value.
15:08	Reserved
07:00	Log Page Identifier (LID): This field specifies the identifier of the log page to retrieve.

5.10.1 Log Specific Information

Figure 72 and Figure 73 define the Log pages that may be retrieved with the Get Log Page command.

Figure 72: Get Log Page – Log Page Identifiers

Log Identifier	O/M	Description
00h		Reserved
01h	M	Error Information
02h	M	SMART / Health Information
03h	M	Firmware Slot Information
04h – 7Fh		Reserved
80h – BFh		I/O Command Set Specific
C0h – FFh		Vendor specific

O/M: O = Optional, M = Mandatory

Figure 73: Get Log Page – Log Page Identifiers, NVM Command Set Specific

Log Identifier	O/M	Description
80h	O	Reservation Notification
81h – BFh		Reserved

O/M: O = Optional, M = Mandatory

5.10.1.1 Error Information (Log Identifier 01h)

This log page is used to describe extended error information for a command that completed with error. Extended error information is provided when the More (M) bit is set to '1' in the Status Field for the completion queue entry associated with the command that completed with error or as part of an asynchronous event with an Error status type. This log page is global to the device.

This error log may return the last n errors. If host software specifies a data transfer of the size of n error logs, then the error logs for the last n errors is returned. The ordering of the entries is based on the time when the error occurred, with the most recent error being returned as the first log.

Each entry in the log page returned is defined in Figure 74. The log page is a set of 64 byte entries; the number of entries supported is indicated in the Identify Controller data structure in Figure 82.

Figure 74: Get Log Page – Error Information Log Entry (Log Identifier 01h)

Bytes	Description								
07:00	Error Count: This is a 64-bit incrementing error count, indicating a unique identifier for this error. The error count starts at 1h, is incremented for each unique error log entry, and is retained across power off conditions. A value of 0h indicates an invalid entry; this value may be used when there are lost entries or when there are fewer errors than the maximum number of entries the controller supports.								
09:08	Submission Queue ID: This field indicates the Submission Queue Identifier of the command that the error information is associated with.								
11:10	Command ID: This field indicates the Command Identifier of the command that the error is associated with.								
13:12	Status Field: This field indicates the Status Field for the command that completed. The Status Field is located in bits 15:01, bit 00 corresponds to the Phase Tag posted for the command.								
15:14	<p>Parameter Error Location: This field indicates the byte and bit of the command parameter that the error is associated with, if applicable. If the parameter spans multiple bytes or bits, then the location indicates the first byte and bit of the parameter.</p> <table border="1"> <thead> <tr> <th>Bits</th> <th>Description</th> </tr> </thead> <tbody> <tr> <td>7:0</td> <td>Byte in command that contained the error. Valid values are 0 to 63.</td> </tr> <tr> <td>10:8</td> <td>Bit in command that contained the error. Valid values are 0 to 7.</td> </tr> <tr> <td>15:11</td> <td>Reserved</td> </tr> </tbody> </table>	Bits	Description	7:0	Byte in command that contained the error. Valid values are 0 to 63.	10:8	Bit in command that contained the error. Valid values are 0 to 7.	15:11	Reserved
Bits	Description								
7:0	Byte in command that contained the error. Valid values are 0 to 63.								
10:8	Bit in command that contained the error. Valid values are 0 to 7.								
15:11	Reserved								
23:16	LBA: This field indicates the first LBA that experienced the error condition, if applicable.								
27:24	Namespace: This field indicates the namespace that the error is associated with, if applicable.								
28	Vendor Specific Information Available: If there is additional vendor specific error information available, this field provides the log page identifier associated with that page. A value of 00h indicates that no additional information is available. Valid values are in the range of 80h to FFh.								
63:29	Reserved								

5.10.1.2 SMART / Health Information (Log Identifier 02h)

This log page is used to provide SMART and general health information. The information provided is over the life of the controller and is retained across power cycles. The log page shall be supported on a global basis. The log page may be supported on a per namespace basis, as indicated in the Identify Controller data structure in Figure 82. To request the global log page, the namespace specified is FFFFFFFFh.

Critical warnings regarding the health of the device may be indicated via an asynchronous event notification to the host. The warnings that results in an asynchronous event notification to the host are configured using the Set Features command; refer to section 5.12.1.11.

Performance of the device may be calculated using parameters returned as part of the SMART / Health Information log. Specifically, the number of Read or Write commands, the amount of data read or written, and the amount of controller busy time enables both I/Os per second and bandwidth to be calculated.

The log page returned is defined in Figure 75.

Figure 75: Get Log Page – SMART / Health Information Log

Bytes	Description														
0	<p>Critical Warning: This field indicates critical warnings for the state of the controller. Each bit corresponds to a critical warning type; multiple bits may be set. If a bit is cleared to '0', then that critical warning does not apply. Critical warnings may result in an asynchronous event notification to the host.</p> <table border="1"> <thead> <tr> <th>Bit</th> <th>Definition</th> </tr> </thead> <tbody> <tr> <td>00</td> <td>If set to '1', then the available spare space has fallen below the threshold.</td> </tr> <tr> <td>01</td> <td>If set to '1', then the temperature has exceeded a critical threshold.</td> </tr> <tr> <td>02</td> <td>If set to '1', then the device reliability has been degraded due to significant media related errors or any internal error that degrades device reliability.</td> </tr> <tr> <td>03</td> <td>If set to '1', then the media has been placed in read only mode.</td> </tr> <tr> <td>04</td> <td>If set to '1', then the volatile memory backup device has failed. This field is only valid if the controller has a volatile memory backup solution.</td> </tr> <tr> <td>07:05</td> <td>Reserved</td> </tr> </tbody> </table>	Bit	Definition	00	If set to '1', then the available spare space has fallen below the threshold.	01	If set to '1', then the temperature has exceeded a critical threshold.	02	If set to '1', then the device reliability has been degraded due to significant media related errors or any internal error that degrades device reliability.	03	If set to '1', then the media has been placed in read only mode.	04	If set to '1', then the volatile memory backup device has failed. This field is only valid if the controller has a volatile memory backup solution.	07:05	Reserved
Bit	Definition														
00	If set to '1', then the available spare space has fallen below the threshold.														
01	If set to '1', then the temperature has exceeded a critical threshold.														
02	If set to '1', then the device reliability has been degraded due to significant media related errors or any internal error that degrades device reliability.														
03	If set to '1', then the media has been placed in read only mode.														
04	If set to '1', then the volatile memory backup device has failed. This field is only valid if the controller has a volatile memory backup solution.														
07:05	Reserved														
2:1	Temperature: Contains the temperature of the overall device (controller and NVM included) in units of Kelvin. If the temperature exceeds the temperature threshold, refer to section 5.12.1.4, then an asynchronous event completion may occur.														
3	Available Spare: Contains a normalized percentage (0 to 100%) of the remaining spare capacity available.														
4	Available Spare Threshold: When the Available Spare falls below the threshold indicated in this field, an asynchronous event completion may occur. The value is indicated as a normalized percentage (0 to 100%).														
5	<p>Percentage Used: Contains a vendor specific estimate of the percentage of device life used based on the actual device usage and the manufacturer's prediction of device life. A value of 100 indicates that the estimated endurance of the device has been consumed, but may not indicate a device failure. The value is allowed to exceed 100. Percentages greater than 254 shall be represented as 255. This value shall be updated once per power-on hour (when the controller is not in a sleep state).</p> <p>Refer to the JEDEC JESD218 standard for SSD device life and endurance measurement techniques.</p>														
31:6	Reserved														
47:32	<p>Data Units Read: Contains the number of 512 byte data units the host has read from the controller; this value does not include metadata. This value is reported in thousands (i.e., a value of 1 corresponds to 1000 units of 512 bytes read) and is rounded up. When the LBA size is a value other than 512 bytes, the controller shall convert the amount of data read to 512 byte units.</p> <p>For the NVM command set, logical blocks read as part of Compare and Read operations shall be included in this value.</p>														
63:48	<p>Data Units Written: Contains the number of 512 byte data units the host has written to the controller; this value does not include metadata. This value is reported in thousands (i.e., a value of 1 corresponds to 1000 units of 512 bytes written) and is rounded up. When the LBA size is a value other than 512 bytes, the controller shall convert the amount of data written to 512 byte units.</p> <p>For the NVM command set, logical blocks written as part of Write operations shall be included in this value. Write Uncorrectable commands shall not impact this value.</p>														
79:64	<p>Host Read Commands: Contains the number of read commands completed by the controller.</p> <p>For the NVM command set, this is the number of Compare and Read commands.</p>														

95:80	Host Write Commands: Contains the number of write commands completed by the controller. For the NVM command set, this is the number of Write commands.
111:96	Controller Busy Time: Contains the amount of time the controller is busy with I/O commands. The controller is busy when there is a command outstanding to an I/O Queue (specifically, a command was issued via an I/O Submission Queue Tail doorbell write and the corresponding completion queue entry has not been posted yet to the associated I/O Completion Queue). This value is reported in minutes.
127:112	Power Cycles: Contains the number of power cycles.
143:128	Power On Hours: Contains the number of power-on hours. This does not include time that the controller was powered and in a low power state condition.
159:144	Unsafe Shutdowns: Contains the number of unsafe shutdowns. This count is incremented when a shutdown notification (CC.SHN) is not received prior to loss of power.
175:160	Media Errors: Contains the number of occurrences where the controller detected an unrecovered data integrity error. Errors such as uncorrectable ECC, CRC checksum failure, or LBA tag mismatch are included in this field.
191:176	Number of Error Information Log Entries: Contains the number of Error Information log entries over the life of the controller.
511:192	Reserved

5.10.1.3 Firmware Slot Information (Log Identifier 03h)

This log page is used to describe the firmware revision stored in each firmware slot supported. The firmware revision is indicated as an ASCII string. The log page also indicates the active slot number. The log page returned is defined in Figure 76. This log page is global to the device.

Figure 76: Get Log Page – Firmware Slot Information Log

Bytes	Description
00	Active Firmware Info (AFI): Specifies information about the active firmware revision. Bit 7 is reserved. Bits 6:4 indicates the firmware slot that is going to be activated at the next controller reset. If this field is 0h, then the controller does not indicate the firmware slot that is going to be activated at the next controller reset. Bit 3 is reserved. Bits 2:0 indicates the firmware slot that contains the actively running firmware revision.
07:01	Reserved
15:08	Firmware Revision for Slot 1 (FRS1): Contains the revision of the firmware downloaded to firmware slot 1. If no valid firmware revision is present or if this slot is unsupported, all zeros shall be returned.
23:16	Firmware Revision for Slot 2 (FRS2): Contains the revision of the firmware downloaded to firmware slot 2. If no valid firmware revision is present or if this slot is unsupported, all zeros shall be returned.
31:24	Firmware Revision for Slot 3 (FRS3): Contains the revision of the firmware downloaded to firmware slot 3. If no valid firmware revision is present or if this slot is unsupported, all zeros shall be returned.
39:32	Firmware Revision for Slot 4 (FRS4): Contains the revision of the firmware downloaded to firmware slot 4. If no valid firmware revision is present or if this slot is unsupported, all zeros shall be returned.
47:40	Firmware Revision for Slot 5 (FRS5): Contains the revision of the firmware downloaded to firmware slot 5. If no valid firmware revision is present or if this slot is unsupported, all zeros shall be returned.

55:48	Firmware Revision for Slot 6 (FRS6): Contains the revision of the firmware downloaded to firmware slot 6. If no valid firmware revision is present or if this slot is unsupported, all zeros shall be returned.
63:56	Firmware Revision for Slot 7 (FRS7): Contains the revision of the firmware downloaded to firmware slot 7. If no valid firmware revision is present or if this slot is unsupported, all zeros shall be returned.
511:64	Reserved

5.10.1.4 NVM Command Set Specific Log Page Identifiers

This section describes NVM Command Set Specific log pages.

5.10.1.4.1 Reservation Notification (Log Identifier 80h)

A Reservation Notification log page is created whenever an unmasked reservation notification occurs on any namespace that may be accessed by the controller. The Get Log Page command returns a data buffer containing a log page corresponding to a single reservation notification. The format of the log page is defined in Figure 77. This log page is global to the controller.

Figure 77: Get Log Page – Reservation Notification Log

Bytes	Description												
07:00	Log Page Count: This is a 64-bit incrementing Reservation Notification log page count, indicating a unique identifier for this notification. The count starts at 0h following a controller reset, is incremented with each unique log entry, and rolls over to zero when the maximum count is reached and a log page is created. A value of 0h indicates an empty log entry.												
08	<p>Reservation Notification Log Page Type: This field indicates the Reservation Notification type described by this log page.</p> <table border="1"> <thead> <tr> <th>Value</th> <th>Definition</th> </tr> </thead> <tbody> <tr> <td>0</td> <td>Empty Log Page: Get Log Page command was processed when no unread Reservation Notification log pages were available. All the fields of an empty log page shall have a value of zero.</td> </tr> <tr> <td>1</td> <td>Registration Preempted</td> </tr> <tr> <td>2</td> <td>Reservation Released</td> </tr> <tr> <td>3</td> <td>Reservation Preempted</td> </tr> <tr> <td>255:4</td> <td>Reserved</td> </tr> </tbody> </table>	Value	Definition	0	Empty Log Page: Get Log Page command was processed when no unread Reservation Notification log pages were available. All the fields of an empty log page shall have a value of zero.	1	Registration Preempted	2	Reservation Released	3	Reservation Preempted	255:4	Reserved
Value	Definition												
0	Empty Log Page: Get Log Page command was processed when no unread Reservation Notification log pages were available. All the fields of an empty log page shall have a value of zero.												
1	Registration Preempted												
2	Reservation Released												
3	Reservation Preempted												
255:4	Reserved												
09	Number of Available Log Pages: This field indicates the number of additional available Reservation Notification log pages (i.e., the number of unread log pages not counting this one). If there are more than 255 additional available log pages, then a value of 255 is returned. A value of zero indicates that there are no additional available log pages.												
11:10	Reserved												
15:12	Namespace ID: This field indicates the namespace ID of the namespace associated with the Reservation Notification described by this log page.												
63:12	Reserved												

5.10.2 Command Completion

A completion queue entry is posted to the Admin Completion Queue if the log has been transferred to the memory buffer indicated in PRP Entry 1. Get Log Page command specific status values are defined in Figure 78.

Figure 78: Get Log Page – Command Specific Status Values

Value	Description
9h	Invalid Log Page: The log page indicated is invalid. This error condition is also returned if a reserved log page is requested.

5.11 Identify command

The Identify command returns a data buffer that describes the controller, namespace capabilities and status, or a list of active namespace IDs. The data structure is 4096 bytes in size. The host specifies as a command parameter whether to return the controller or namespace specific data structure. For the namespace data structure, the definition of the structure is specific to the I/O Command Set selected for use.

When the host specifies active namespaces to be returned, then a list of 1024 namespace IDs is returned containing active namespace IDs in increasing order that are greater than the value specified in the Namespace Identifier (CDW1.NSID) field of the command. If there are fewer than 1024 active namespaces greater than the value in the CDW1.NSID field, then the unused portion of the list is zero filled. If there are 1024 or more active namespaces with namespace identifiers greater than the value in the CDW1.NSID field, then the last Namespace Identifier in the list is non-zero.

The Identify command uses the PRP Entry 1, PRP Entry 2, and Command Dword 10 fields. All other command specific fields are reserved.

Figure 79: Identify – PRP Entry 1

Bit	Description
63:00	PRP Entry 1 (PRP1): Indicates a data buffer that the Identify data structure shall be returned to. The buffer shall not have more than one physical discontinuity.

Figure 80: Identify – PRP Entry 2

Bit	Description
63:00	PRP Entry 2 (PRP2): This field contains the second PRP entry that specifies the location where data should be transferred to (if there is a physical discontinuity). This field shall not be a pointer to a PRP List.

Figure 81: Identify – Command Dword 10

Bit	Description										
31:02	Reserved										
01:00	Controller or Namespace Structure (CNS): This field specifies the information to be returned to the host. <table border="1" style="margin-left: 20px;"> <thead> <tr> <th>Value</th> <th>Definition</th> </tr> </thead> <tbody> <tr> <td>00b</td> <td>The Identify Namespace data structure is returned to the host for the namespace specified in the Namespace Identifier (CDW1.NSID) field.</td> </tr> <tr> <td>01b</td> <td>The Identify Controller data structure is returned to the host.</td> </tr> <tr> <td>10b</td> <td>A list of up to 1024 active namespace IDs is returned to the host containing active namespaces with a namespace identifier greater than the value specified in the Namespace Identifier (CDW1.NSID) field.</td> </tr> <tr> <td>11b</td> <td>Reserved</td> </tr> </tbody> </table>	Value	Definition	00b	The Identify Namespace data structure is returned to the host for the namespace specified in the Namespace Identifier (CDW1.NSID) field.	01b	The Identify Controller data structure is returned to the host.	10b	A list of up to 1024 active namespace IDs is returned to the host containing active namespaces with a namespace identifier greater than the value specified in the Namespace Identifier (CDW1.NSID) field.	11b	Reserved
		Value	Definition								
		00b	The Identify Namespace data structure is returned to the host for the namespace specified in the Namespace Identifier (CDW1.NSID) field.								
		01b	The Identify Controller data structure is returned to the host.								
		10b	A list of up to 1024 active namespace IDs is returned to the host containing active namespaces with a namespace identifier greater than the value specified in the Namespace Identifier (CDW1.NSID) field.								
11b	Reserved										

Figure 82: Identify – Identify Controller Data Structure

Bytes	O/M	Description
Controller Capabilities and Features		
01:00	M	PCI Vendor ID (VID): Contains the company vendor identifier that is assigned by the PCI SIG. This is the same value as reported in the ID register in section 2.1.1.
03:02	M	PCI Subsystem Vendor ID (SSVID): Contains the company vendor identifier that is assigned by the PCI SIG for the subsystem. This is the same value as reported in the SS register in section 2.1.17.
23:04	M	Serial Number (SN): Contains the serial number for the NVM subsystem that is assigned by the vendor as an ASCII string. Refer to section 7.8 for unique identifier requirements.
63:24	M	Model Number (MN): Contains the model number for the NVM subsystem that is assigned by the vendor as an ASCII string. Refer to section 7.8 for unique identifier requirements.
71:64	M	Firmware Revision (FR): Contains the currently active firmware revision for the NVM subsystem. This is the same revision information that may be retrieved with the Get Log Page command, refer to section 5.10.1.3. See section 1.8 for ASCII string requirements.
72	M	Recommended Arbitration Burst (RAB): This is the recommended Arbitration Burst size. Refer to section 4.8.
75:73	M	IEEE OUI Identifier (IEEE): Contains the Organization Unique Identifier (OUI) for the controller vendor. The OUI shall be a valid IEEE/RAC assigned identifier that may be registered at http://standards.ieee.org/develop/regauth/oui/public.html .
76	O	Controller Multi-Path I/O and Namespace Sharing Capabilities (CMIC): This field specifies multi-path I/O and namespace sharing capabilities of the controller and NVM subsystem. Bits 7:3 are reserved Bit 2: If set to '1' then the controller is associated with an SR-IOV Virtual Function. If cleared to '0' then the controller is associated with a PCI Function. Bit 1: If set to '1' then the NVM subsystem may contain two or more controllers. If cleared to '0' then the NVM subsystem contains only a single controller. Bit 0: If set to '1' then the NVM subsystem may contain two or more physical PCI Express ports. If cleared to '0' then the NVM subsystem contains only a single PCI Express port.

77	M	Maximum Data Transfer Size (MDTS): This field indicates the maximum data transfer size between the host and the controller. The host should not submit a command that exceeds this transfer size. If a command is submitted that exceeds the transfer size, then the command is aborted with a status of Invalid Field in Command. The value is in units of the minimum memory page size (CAP.MPSMIN) and is reported as a power of two (2^n). A value of 0h indicates no restrictions on transfer size. The restriction includes metadata if it is interleaved with the logical block data.
79:78	M	Controller ID (CNTLID): Contains the NVM subsystem unique controller identifier associated with the controller. Refer to section 7.7 for unique identifier requirements.
255:80		Reserved
Admin Command Set Attributes		
257:256	M	Optional Admin Command Support (OACS): This field indicates the optional Admin commands supported by the controller. Refer to section 5. Bits 15:3 are reserved. Bit 2 if set to '1' then the controller supports the Firmware Activate and Firmware Download commands. If cleared to '0' then the controller does not support the Firmware Activate and Firmware Download commands. Bit 1 if set to '1' then the controller supports the Format NVM command. If cleared to '0' then the controller does not support the Format NVM command. Bit 0 if set to '1' then the controller supports the Security Send and Security Receive commands. If cleared to '0' then the controller does not support the Security Send and Security Receive commands.
258	M	Abort Command Limit (ACL): This field is used to convey the maximum number of concurrently outstanding Abort commands supported by the controller (see section 5.1). This is a 0's based value. It is recommended that implementations support a minimum of four Abort commands outstanding simultaneously.
259	M	Asynchronous Event Request Limit (AERL): This field is used to convey the maximum number of concurrently outstanding Asynchronous Event Request commands supported by the controller (see section 5.2). This is a 0's based value. It is recommended that implementations support a minimum of four Asynchronous Event Request Limit commands outstanding simultaneously.
260	M	Firmware Updates (FRMW): This field indicates capabilities regarding firmware updates. Refer to section 8.1 for more information on the firmware update process. Bits 7:4 are reserved. Bits 3:1 indicate the number of firmware slots that the device supports. This field shall specify a value between one and seven, indicating that at least one firmware slot is supported and up to seven maximum. This corresponds to firmware slots 1 through 7. Bit 0 if set to '1' indicates that the first firmware slot (slot 1) is read only. If cleared to '0' then the first firmware slot (slot 1) is read/write. Implementations may choose to have a baseline read only firmware image.
261	M	Log Page Attributes (LPA): This field indicates optional attributes for log pages that are accessed via the Get Log Page command. Bits 7:1 are reserved. Bit 0 if set to '1' then the controller supports the SMART / Health information log page on a per namespace basis. If cleared to '0' then the controller does not support the SMART / Health information log page on a per namespace basis; the log page returned is global for all namespaces.
262	M	Error Log Page Entries (ELPE): This field indicates the number of Error Information log entries that are stored by the controller. This field is a 0's based value.

263	M	<p>Number of Power States Support (NPSS): This field indicates the number of NVM Express power states supported by the controller. This is a 0's based value. Refer to section 8.4.</p> <p>Power states are numbered sequentially starting at power state 0. A controller shall support at least one power state (i.e., power state 0) and may support up to 31 additional power states (i.e., up to 32 total).</p>
264	M	<p>Admin Vendor Specific Command Configuration (AVSCC): This field indicates the configuration settings for Admin Vendor Specific command handling. Refer to section 8.7.</p> <p>Bits 7:1 are reserved.</p> <p>Bit 0 if set to '1' indicates that all Admin Vendor Specific Commands use the format defined in Figure 13. If cleared to '0' indicates that the format of all Admin Vendor Specific Commands are vendor specific.</p>
265	O	<p>Autonomous Power State Transition Attributes (APSTA): This field indicates the attributes of the autonomous power state transition feature. Refer to section 8.4.1.</p> <p>Bits 7:1 are reserved.</p> <p>Bit 0 if set to '1' then the controller supports autonomous power state transitions. If cleared to '0' then the controller does not support autonomous power state transitions.</p>
511:266		Reserved
NVM Command Set Attributes		
512	M	<p>Submission Queue Entry Size (SQES): This field defines the required and maximum Submission Queue entry size when using the NVM Command Set.</p> <p>Bits 7:4 define the maximum Submission Queue entry size when using the NVM Command Set. This value is larger than or equal to the required SQ entry size. The value is in bytes and is reported as a power of two (2^n). The recommended value is 6, corresponding to a standard NVM Command Set SQ entry size of 64 bytes. Controllers that implement proprietary extensions may support a larger value.</p> <p>Bits 3:0 define the required Submission Queue Entry size when using the NVM Command Set. This is the minimum entry size that may be used. The value is in bytes and is reported as a power of two (2^n). The required value shall be 6, corresponding to 64.</p>
513	M	<p>Completion Queue Entry Size (CQES): This field defines the required and maximum Completion Queue entry size when using the NVM Command Set.</p> <p>Bits 7:4 define the maximum Completion Queue entry size when using the NVM Command Set. This value is larger than or equal to the required CQ entry size. The value is in bytes and is reported as a power of two (2^n). The recommended value is 4, corresponding to a standard NVM Command Set CQ entry size of 16 bytes. Controllers that implement proprietary extensions may support a larger value.</p> <p>Bits 3:0 define the required Completion Queue entry size when using the NVM Command Set. This is the minimum entry size that may be used. The value is in bytes and is reported as a power of two (2^n). The required value shall be 4, corresponding to 16.</p>
515:514		Reserved
519:516	M	<p>Number of Namespaces (NN): This field defines the number of valid namespaces present for the controller. Namespaces shall be allocated in order (starting with 1) and packed sequentially.</p>

521:520	M	<p>Optional NVM Command Support (ONCS): This field indicates the optional NVM commands supported by the controller. Refer to section 6.</p> <p>Bits 15:6 are reserved.</p> <p>Bit 5 if set to '1' then the controller supports reservations. If cleared to '0' then the controller does not support reservations. If the controller supports reservations, then it shall support the following commands associated with reservations: Reservation Report, Reservation Register, Reservation Acquire, and Reservation Release. Refer to section 8.8 for additional requirements.</p> <p>Bit 4 if set to '1' then the controller supports the Save field in the Set Features command and the Select field in the Get Features command. If cleared to '0' then the controller does not support the Save field in the Set Features command and the Select field in the Get Features command.</p> <p>Bit 3 if set to '1' then the controller supports the Write Zeroes command. If cleared to '0' then the controller does not support the Write Zeroes command.</p> <p>Bit 2 if set to '1' then the controller supports the Dataset Management command. If cleared to '0' then the controller does not support the Dataset Management command.</p> <p>Bit 1 if set to '1' then the controller supports the Write Uncorrectable command. If cleared to '0' then the controller does not support the Write Uncorrectable command.</p> <p>Bit 0 if set to '1' then the controller supports the Compare command. If cleared to '0' then the controller does not support the Compare command.</p>
523:522	M	<p>Fused Operation Support (FUSES): This field indicates the fused operations that the controller supports. Refer to section 6.1.</p> <p>Bits 15:1 are reserved.</p> <p>Bit 0 if set to '1' then the controller supports the Compare and Write fused operation. If cleared to '0' then the controller does not support the Compare and Write fused operation. Compare shall be the first command in the sequence.</p>
524	M	<p>Format NVM Attributes (FNA): This field indicates attributes for the Format NVM command.</p> <p>Bits 7:3 are reserved.</p> <p>Bit 2 indicates whether cryptographic erase is supported as part of the secure erase functionality. If set to '1', then cryptographic erase is supported. If cleared to '0', then cryptographic erase is not supported.</p> <p>Bit 1 indicates whether secure erase functionality applies to all namespaces or is specific to a particular namespace. If set to '1', then a secure erase of a particular namespace as part of a format results in a secure erase of all namespaces. If cleared to '0', then a secure erase as part of a format is performed on a per namespace basis.</p> <p>Bit 0 indicates whether the format operation applies to all namespaces or is specific to a particular namespace. If set to '1', then all namespaces shall be configured with the same attributes and a format of any namespace results in a format of all namespaces. If cleared to '0', then the controller supports format on a per namespace basis.</p>

525	M	<p>Volatile Write Cache (VWC): This field indicates attributes related to the presence of a volatile write cache in the implementation.</p> <p>Bits 7:1 are reserved.</p> <p>Bit 0 if set to '1' indicates that a volatile write cache is present. If cleared to '0', a volatile write cache is not present. If a volatile write cache is present, then the host may issue Flush commands and control whether it is enabled with Set Features specifying the Volatile Write Cache feature identifier. If a volatile write cache is not present, the host shall not submit Flush commands nor Set Features or Get Features with the Volatile Write Cache identifier.</p>										
527:526	M	<p>Atomic Write Unit Normal (AWUN): This field indicates the atomic write size for the controller during normal operation. This field is specified in logical blocks and is a 0's based value. If a write is submitted of this size or less, the host is guaranteed that the write is atomic to the NVM with respect to other read or write operations. A value of FFFFh indicates all commands are atomic as this is the largest command size. It is recommended that implementations support a minimum of 128KB (appropriately scaled based on LBA size).</p>										
529:528	M	<p>Atomic Write Unit Power Fail (AWUPF): This field indicates the atomic write size for the controller during a power fail condition. This field is specified in logical blocks and is a 0's based value. If a write is submitted of this size or less, the host is guaranteed that the write is atomic to the NVM with respect to other read or write operations.</p>										
530	M	<p>NVM Vendor Specific Command Configuration (NVSCC): This field indicates the configuration settings for NVM Vendor Specific command handling. Refer to section 8.7.</p> <p>Bits 7:1 are reserved.</p> <p>Bit 0 if set to '1' indicates that all NVM Vendor Specific Commands use the format defined in Figure 13. If cleared to '0' indicates that the format of all NVM Vendor Specific Commands are vendor specific.</p>										
531	M	Reserved										
533:532	O	<p>Atomic Compare & Write Unit (ACWU): This field indicates the atomic write size for the controller for a Compare and Write fused command. This field shall be supported if the Compare and Write fused command is supported. This field is specified in logical blocks and is a 0's based value. If a Compare and Write is submitted that requests a transfer size larger than this value, then the controller shall fail the command with a status code of Invalid Field in Command. If Compare and Write is not a supported fused command, then this field shall be 0h.</p>										
535:534	M	Reserved										
539:536	O	<p>SGL Support (SGLS): This field indicates if SGLs are supported for the NVM Command Set and the particular SGL types supported. Refer to section 4.4.</p> <table border="1"> <thead> <tr> <th>Bits</th> <th>Description</th> </tr> </thead> <tbody> <tr> <td>31:17</td> <td>Reserved</td> </tr> <tr> <td>16</td> <td>If set to '1', then the SGL Bit Bucket descriptor is supported. If cleared to '0', then the SGL Bit Bucket descriptor is not supported.</td> </tr> <tr> <td>15:01</td> <td>Reserved</td> </tr> <tr> <td>00</td> <td>If set to '1', then the controller supports SGLs for the NVM Command Set including the SGL Data Block, SGL Segment, and SGL Last Segment descriptor types. If cleared to '0', then the controller does not support SGLs for the NVM Command Set and all other bits in this field shall be cleared to '0'.</td> </tr> </tbody> </table>	Bits	Description	31:17	Reserved	16	If set to '1', then the SGL Bit Bucket descriptor is supported. If cleared to '0', then the SGL Bit Bucket descriptor is not supported.	15:01	Reserved	00	If set to '1', then the controller supports SGLs for the NVM Command Set including the SGL Data Block, SGL Segment, and SGL Last Segment descriptor types. If cleared to '0', then the controller does not support SGLs for the NVM Command Set and all other bits in this field shall be cleared to '0'.
Bits	Description											
31:17	Reserved											
16	If set to '1', then the SGL Bit Bucket descriptor is supported. If cleared to '0', then the SGL Bit Bucket descriptor is not supported.											
15:01	Reserved											
00	If set to '1', then the controller supports SGLs for the NVM Command Set including the SGL Data Block, SGL Segment, and SGL Last Segment descriptor types. If cleared to '0', then the controller does not support SGLs for the NVM Command Set and all other bits in this field shall be cleared to '0'.											
703:540	M	Reserved										
I/O Command Set Attributes												
2047:704		Reserved										
Power State Descriptors												

2079:2048	M	Power State 0 Descriptor (PSD0): This field indicates the characteristics of power state 0. The format of this field is defined in Figure 83.
2111:2080	O	Power State 1 Descriptor (PSD1): This field indicates the characteristics of power state 1. The format of this field is defined in Figure 83.
2143:2112	O	Power State 2 Descriptor (PSD2): This field indicates the characteristics of power state 2. The format of this field is defined in Figure 83.
2175:2144	O	Power State 3 Descriptor (PSD3): This field indicates the characteristics of power state 3. The format of this field is defined in Figure 83.
2207:2176	O	Power State 4 Descriptor (PSD4): This field indicates the characteristics of power state 4. The format of this field is defined in Figure 83.
2239:2208	O	Power State 5 Descriptor (PSD5): This field indicates the characteristics of power state 5. The format of this field is defined in Figure 83.
2271:2240	O	Power State 6 Descriptor (PSD6): This field indicates the characteristics of power state 6. The format of this field is defined in Figure 83.
2303:2272	O	Power State 7 Descriptor (PSD7): This field indicates the characteristics of power state 7. The format of this field is defined in Figure 83.
2335:2304	O	Power State 8 Descriptor (PSD8): This field indicates the characteristics of power state 8. The format of this field is defined in Figure 83.
2367:2336	O	Power State 9 Descriptor (PSD9): This field indicates the characteristics of power state 9. The format of this field is defined in Figure 83.
2399:2368	O	Power State 10 Descriptor (PSD10): This field indicates the characteristics of power state 10. The format of this field is defined in Figure 83.
2431:2400	O	Power State 11 Descriptor (PSD11): This field indicates the characteristics of power state 11. The format of this field is defined in Figure 83.
2463:2432	O	Power State 12 Descriptor (PSD12): This field indicates the characteristics of power state 12. The format of this field is defined in Figure 83.
2495:2464	O	Power State 13 Descriptor (PSD13): This field indicates the characteristics of power state 13. The format of this field is defined in Figure 83.
2527:2496	O	Power State 14 Descriptor (PSD14): This field indicates the characteristics of power state 14. The format of this field is defined in Figure 83.
2559:2528	O	Power State 15 Descriptor (PSD15): This field indicates the characteristics of power state 15. The format of this field is defined in Figure 83.
2591:2560	O	Power State 16 Descriptor (PSD16): This field indicates the characteristics of power state 16. The format of this field is defined in Figure 83.
2623:2592	O	Power State 17 Descriptor (PSD17): This field indicates the characteristics of power state 17. The format of this field is defined in Figure 83.
2655:2624	O	Power State 18 Descriptor (PSD18): This field indicates the characteristics of power state 18. The format of this field is defined in Figure 83.
2687:2656	O	Power State 19 Descriptor (PSD19): This field indicates the characteristics of power state 19. The format of this field is defined in Figure 83.
2719:2688	O	Power State 20 Descriptor (PSD20): This field indicates the characteristics of power state 20. The format of this field is defined in Figure 83.
2751:2720	O	Power State 21 Descriptor (PSD21): This field indicates the characteristics of power state 21. The format of this field is defined in Figure 83.
2783:2752	O	Power State 22 Descriptor (PSD22): This field indicates the characteristics of power state 22. The format of this field is defined in Figure 83.
2815:2784	O	Power State 23 Descriptor (PSD23): This field indicates the characteristics of power state 23. The format of this field is defined in Figure 83.
2847:2816	O	Power State 24 Descriptor (PSD24): This field indicates the characteristics of power state 24. The format of this field is defined in Figure 83.
2879:2848	O	Power State 25 Descriptor (PSD25): This field indicates the characteristics of power state 25. The format of this field is defined in Figure 83.
2911:2880	O	Power State 26 Descriptor (PSD26): This field indicates the characteristics of power state 26. The format of this field is defined in Figure 83.
2943:2912	O	Power State 27 Descriptor (PSD27): This field indicates the characteristics of power state 27. The format of this field is defined in Figure 83.
2975:2944	O	Power State 28 Descriptor (PSD28): This field indicates the characteristics of power state 28. The format of this field is defined in Figure 83.
3007:2976	O	Power State 29 Descriptor (PSD29): This field indicates the characteristics of power state 29. The format of this field is defined in Figure 83.

3039:3008	○	Power State 30 Descriptor (PSD30): This field indicates the characteristics of power state 30. The format of this field is defined in Figure 83.
3071:3040	○	Power State 31 Descriptor (PSD31): This field indicates the characteristics of power state 31. The format of this field is defined in Figure 83.
Vendor Specific		
4095:3072	○	Vendor Specific (VS): This range of bytes is allocated for vendor specific usage.

Figure 83: Identify – Power State Descriptor Data Structure

Bits	Description
255:125	Reserved
124:120	Relative Write Latency (RWL): This field indicates the relative write latency associated with this power state. The value in this field shall be less than the number of supported power states (e.g., if the controller supports 16 power states, then valid values are 0 through 15). A lower value means lower write latency.
119:117	Reserved
116:112	Relative Write Throughput (RWT): This field indicates the relative write throughput associated with this power state. The value in this field shall be less than the number of supported power states (e.g., if the controller supports 16 power states, then valid values are 0 through 15). A lower value means higher write throughput.
111:109	Reserved
108:104	Relative Read Latency (RRL): This field indicates the relative read latency associated with this power state. The value in this field shall be less than the number of supported power states (e.g., if the controller supports 16 power states, then valid values are 0 through 15). A lower value means lower read latency.
103:101	Reserved
100:96	Relative Read Throughput (RRT): This field indicates the relative read throughput associated with this power state. The value in this field shall be less than the number of supported power states (e.g., if the controller supports 16 power states, then valid values are 0 through 15). A lower value means higher read throughput.
95:64	Exit Latency (EXLAT): This field indicates the maximum exit latency in microseconds associated with exiting this power state.
63:32	Entry Latency (ENLAT): This field indicates the maximum entry latency in microseconds associated with entering this power state.
31:26	Reserved
25	Non-Operational State (NOPS): This field indicates whether the controller processes I/O commands in this power state. If this field is cleared to '0', then the controller processes I/O commands in this power state. If this field is set to '1', then the controller does not process I/O commands in this power state.
24	Max Power Scale (MPS): This field indicates the scale for the Maximum Power field. If this field is cleared to '0', then the scale of the Maximum Power field is in 0.01 Watts. If this field is set to '1', then the scale of the Maximum Power field is in 0.0001 Watts.
23:16	Reserved
15:00	Maximum Power (MP): This field indicates the maximum power consumed by the NVM subsystem in this power state. The power in Watts is equal to the value in this field multiplied by the scale specified in the Max Power Scale field.

Figure 84 shows the Identify Namespace data structure for the NVM Command Set. If the namespace ID is inactive, then the command completes and the value of all fields in the returned data structure except the Vendor Specific (VS) range is zero. The values returned in the Vendor Specific (VS) range are vendor specific.

Figure 84: Identify – Identify Namespace Data Structure, NVM Command Set Specific

Bytes	O/M	Description
7:0	M	<p>Namespace Size (NSZE): This field indicates the total size of the namespace in logical blocks. A namespace of size n consists of LBA 0 through $(n - 1)$. The number of logical blocks is based on the formatted LBA size. This field is undefined prior to the namespace being formatted.</p> <p>Note: The creation of the namespace(s) and initial format operation are outside the scope of this specification.</p>
15:8	M	<p>Namespace Capacity (NCAP): This field indicates the maximum number of logical blocks that may be allocated in the namespace at any point in time. The number of logical blocks is based on the formatted LBA size. This field is undefined prior to the namespace being formatted. This field is used in the case of thin provisioning and reports a value that is smaller than or equal to the Namespace Size. Spare LBAs are not reported as part of this field.</p> <p>A value of 0h for the Namespace Capacity indicates that the namespace ID is an inactive namespace ID.</p> <p>A logical block is allocated when it is written with a Write or Write Uncorrectable command. A logical block may be deallocated using the Dataset Management command.</p>
23:16	M	<p>Namespace Utilization (NUSE): This field indicates the current number of logical blocks allocated in the namespace. This field is smaller than or equal to the Namespace Capacity. The number of logical blocks is based on the formatted LBA size.</p> <p>When using the NVM command set: A logical block is allocated when it is written with a Write or Write Uncorrectable command. A logical block may be deallocated using the Dataset Management command.</p>
24	M	<p>Namespace Features (NSFEAT): This field defines features of the namespace.</p> <p>Bits 7:1 are reserved.</p> <p>Bit 0 if set to '1' indicates that the namespace supports thin provisioning. Specifically, the Namespace Capacity reported may be less than the Namespace Size. When this feature is supported and the Dataset Management command is supported then deallocating LBAs shall be reflected in the Namespace Utilization field. Bit 0 if cleared to '0' indicates that thin provisioning is not supported and the Namespace Size and Namespace Capacity fields report the same value.</p>
25	M	<p>Number of LBA Formats (NLBAF): This field defines the number of supported LBA data size and metadata size combinations supported by the namespace. LBA formats shall be allocated in order (starting with 0) and packed sequentially. This is a 0's based value. The maximum number of LBA formats that may be indicated as supported is 16. The supported LBA formats are indicated in bytes 128 – 191 in this data structure.</p> <p>The metadata may be either transferred as part of the LBA (creating an extended LBA which is a larger LBA size that is exposed to the application) or it may be transferred as a separate contiguous buffer of data. The metadata shall not be split between the LBA and a separate metadata buffer.</p> <p>It is recommended that software and controllers transition to an LBA size that is 4KB or larger for ECC efficiency at the controller. If providing metadata, it is recommended that at least 8 bytes are provided per logical block to enable use with end-to-end data protection, refer to section 8.2.</p>

26	M	<p>Formatted LBA Size (FLBAS): This field indicates the LBA data size & metadata size combination that the namespace has been formatted with.</p> <p>Bits 7:5 are reserved.</p> <p>Bit 4 if set to '1' indicates that the metadata is transferred at the end of the data LBA, creating an extended data LBA. Bit 4 if cleared to '0' indicates that all of the metadata for a command is transferred as a separate contiguous buffer of data.</p> <p>Bits 3:0 indicates one of the 16 supported combinations indicated in this data structure. This is a 0's based value.</p>
27	M	<p>Metadata Capabilities (MC): This field indicates the capabilities for metadata.</p> <p>Bits 7:2 are reserved.</p> <p>Bit 1 if set to '1' indicates the namespace supports the metadata being transferred as part of a separate buffer that is specified in the Metadata Pointer. Bit 1 if cleared to '0' indicates that the namespace does not support the metadata being transferred as part of a separate buffer.</p> <p>Bit 0 if set to '1' indicates that the namespace supports the metadata being transferred as part of an extended data LBA. Specifically, the metadata is transferred as part of the data PRP Lists. Bit 0 if cleared to '0' indicates that the namespace does not support the metadata being transferred as part of an extended data LBA.</p>
28	M	<p>End-to-end Data Protection Capabilities (DPC): This field indicates the capabilities for the end-to-end data protection feature. Multiple bits may be set in this field. Refer to section 8.3.</p> <p>Bits 7:5 are reserved.</p> <p>Bit 4 if set to '1' indicates that the namespace supports protection information transferred as the last eight bytes of metadata. Bit 4 if cleared to '0' indicates that the namespace does not support protection information transferred as the last eight bytes of metadata.</p> <p>Bit 3 if set to '1' indicates that the namespace supports protection information transferred as the first eight bytes of metadata. Bit 3 if cleared to '0' indicates that the namespace does not support protection information transferred as the first eight bytes of metadata.</p> <p>Bit 2 if set to '1' indicates that the namespace supports Protection Information Type 3. Bit 2 if cleared to '0' indicates that the namespace does not support Protection Information Type 3.</p> <p>Bit 1 if set to '1' indicates that the namespace supports Protection Information Type 2. Bit 1 if cleared to '0' indicates that the namespace does not support Protection Information Type 2.</p> <p>Bit 0 if set to '1' indicates that the namespace supports Protection Information Type 1. Bit 0 if cleared to '0' indicates that the namespace does not support Protection Information Type 1.</p>

29	M	<p>End-to-end Data Protection Type Settings (DPS): This field indicates the Type settings for the end-to-end data protection feature. Refer to section 8.3.</p> <p>Bits 7:4 are reserved.</p> <p>Bit 3 if set to '1' indicates that the protection information, if enabled, is transferred as the first eight bytes of metadata. Bit 3 if cleared to '0' indicates that the protection information, if enabled, is transferred as the last eight bytes of metadata.</p> <p>Bits 2:0 indicate whether Protection Information is enabled and the type of Protection Information enabled. The values for this field have the following meanings:</p> <table border="1" data-bbox="561 520 1317 695"> <thead> <tr> <th>Value</th> <th>Definition</th> </tr> </thead> <tbody> <tr> <td>000b</td> <td>Protection information is not enabled</td> </tr> <tr> <td>001b</td> <td>Protection information is enabled, Type 1</td> </tr> <tr> <td>010b</td> <td>Protection information is enabled, Type 2</td> </tr> <tr> <td>011b</td> <td>Protection information is enabled, Type 3</td> </tr> <tr> <td>100b – 111b</td> <td>Reserved</td> </tr> </tbody> </table>	Value	Definition	000b	Protection information is not enabled	001b	Protection information is enabled, Type 1	010b	Protection information is enabled, Type 2	011b	Protection information is enabled, Type 3	100b – 111b	Reserved
Value	Definition													
000b	Protection information is not enabled													
001b	Protection information is enabled, Type 1													
010b	Protection information is enabled, Type 2													
011b	Protection information is enabled, Type 3													
100b – 111b	Reserved													
30	O	<p>Namespace Multi-path I/O and Namespace Sharing Capabilities (NMIC): This field specifies multi-path I/O and namespace sharing capabilities of the namespace.</p> <p>Bits 7:1 are reserved</p> <p>Bit 0: If set to '1' then the NVM namespace may be accessible by two or more controllers in the NVM subsystem (i.e., may be a shared namespace). If cleared to '0' then the NVM namespace is a private namespace and may only be accessed by the controller that returned this namespace data structure.</p>												
31	O	<p>Reservation Capabilities (RESCAP): This field indicates the reservation capabilities of the namespace. A value of 00h in this field indicates that reservations are not supported by this namespace. Refer to section 8.8 for more details.</p> <p>Bit 7 is reserved</p> <p>Bit 6 if set to '1' indicates that the namespace supports the Exclusive Access – All Registrants reservation type. If this bit is cleared to '0', then the namespace does not support the Exclusive Access – All Registrants reservation type.</p> <p>Bit 5 if set to '1' indicates that the namespace supports the Write Exclusive – All Registrants reservation type. If this bit is cleared to '0', then the namespace does not support the Write Exclusive – All Registrants reservation type.</p> <p>Bit 4 if set to '1' indicates that the namespace supports the Exclusive Access – Registrants Only reservation type. If this bit is cleared to '0', then the namespace does not support the Exclusive Access – Registrants Only reservation type.</p> <p>Bit 3 if set to '1' indicates that the namespace supports the Write Exclusive – Registrants Only reservation type. If this bit is cleared to '0', then the namespace does not support the Write Exclusive – Registrants Only reservation type.</p> <p>Bit 2 if set to '1' indicates that the namespace supports the Exclusive Access reservation type. If this bit is cleared to '0', then the namespace does not support the Exclusive Access reservation type.</p> <p>Bit 1 if set to '1' indicates that the namespace supports the Write Exclusive reservation type. If this bit is cleared to '0', then the namespace does not support the Write Exclusive reservation type.</p> <p>Bit 0 if set to '1' indicates that the namespace supports the Persist Through Power Loss capability. If this bit is cleared to '0', then the namespace does not support the Persist Through Power Loss Capability.</p>												

119:32		Reserved
127:120	M	<p>IEEE Extended Unique Identifier (EUI64): This field contains a 64-bit IEEE Extended Unique Identifier (EUI-64) that is globally unique and assigned to the namespace when the namespace is created. This field remains fixed throughout the life of the namespace and is preserved across namespace and controller operations (e.g., controller reset, namespace format, etc.).</p> <p>The EUI-64 is a concatenation of a 24-bit or 36-bit company_id value assigned by the IEEE Registration Authority and an extension identifier assigned by the corresponding organization. See the IEEE EUI-64 guidelines for more information.</p>
131:128	M	LBA Format 0 Support (LBAF0): This field indicates the LBA format 0 that is supported by the controller. The LBA format field is defined in Figure 85.
135:132	O	LBA Format 1 Support (LBAF1): This field indicates the LBA format 1 that is supported by the controller. The LBA format field is defined in Figure 85.
139:136	O	LBA Format 2 Support (LBAF2): This field indicates the LBA format 2 that is supported by the controller. The LBA format field is defined in Figure 85.
143:140	O	LBA Format 3 Support (LBAF3): This field indicates the LBA format 3 that is supported by the controller. The LBA format field is defined in Figure 85.
147:144	O	LBA Format 4 Support (LBAF4): This field indicates the LBA format 4 that is supported by the controller. The LBA format field is defined in Figure 85.
151:148	O	LBA Format 5 Support (LBAF5): This field indicates the LBA format 5 that is supported by the controller. The LBA format field is defined in Figure 85.
155:152	O	LBA Format 6 Support (LBAF6): This field indicates the LBA format 6 that is supported by the controller. The LBA format field is defined in Figure 85.
159:156	O	LBA Format 7 Support (LBAF7): This field indicates the LBA format 7 that is supported by the controller. The LBA format field is defined in Figure 85.
163:160	O	LBA Format 8 Support (LBAF8): This field indicates the LBA format 8 that is supported by the controller. The LBA format field is defined in Figure 85.
167:164	O	LBA Format 9 Support (LBAF9): This field indicates the LBA format 9 that is supported by the controller. The LBA format field is defined in Figure 85.
171:168	O	LBA Format 10 Support (LBAF10): This field indicates the LBA format 10 that is supported by the controller. The LBA format field is defined in Figure 85.
175:172	O	LBA Format 11 Support (LBAF11): This field indicates the LBA format 11 that is supported by the controller. The LBA format field is defined in Figure 85.
179:176	O	LBA Format 12 Support (LBAF12): This field indicates the LBA format 12 that is supported by the controller. The LBA format field is defined in Figure 85.
183:180	O	LBA Format 13 Support (LBAF13): This field indicates the LBA format 13 that is supported by the controller. The LBA format field is defined in Figure 85.
187:184	O	LBA Format 14 Support (LBAF14): This field indicates the LBA format 14 that is supported by the controller. The LBA format field is defined in Figure 85.
191:188	O	LBA Format 15 Support (LBAF15): This field indicates the LBA format 15 that is supported by the controller. The LBA format field is defined in Figure 85.
383:192		Reserved
4095:384	O	Vendor Specific (VS): This range of bytes is allocated for vendor specific usage.

Figure 85: Identify – LBA Format Data Structure, NVM Command Set Specific

Bits	Description										
31:26	Reserved										
25:24	<p>Relative Performance (RP): This field indicates the relative performance of the LBA format indicated relative to other LBA formats supported by the controller. Depending on the size of the LBA and associated metadata, there may be performance implications. The performance analysis is based on better performance on a queue depth 32 with 4KB read workload. The meanings of the values indicated are included in the following table.</p> <table border="1"> <thead> <tr> <th>Value</th> <th>Definition</th> </tr> </thead> <tbody> <tr> <td>00b</td> <td>Best performance</td> </tr> <tr> <td>01b</td> <td>Better performance</td> </tr> <tr> <td>10b</td> <td>Good performance</td> </tr> <tr> <td>11b</td> <td>Degraded performance</td> </tr> </tbody> </table>	Value	Definition	00b	Best performance	01b	Better performance	10b	Good performance	11b	Degraded performance
Value	Definition										
00b	Best performance										
01b	Better performance										
10b	Good performance										
11b	Degraded performance										
23:16	<p>LBA Data Size (LBADS): This field indicates the LBA data size supported. The value is reported in terms of a power of two (2^n). A value smaller than 9 (i.e. 512 bytes) is not supported. If the value reported is 0h then the LBA format is not supported / used.</p>										
15:00	<p>Metadata Size (MS): This field indicates the number of metadata bytes provided per LBA based on the LBA Data Size indicated. The namespace may support the metadata being transferred as part of an extended data LBA or as part of a separate contiguous buffer. If end-to-end data protection is enabled, then the first eight bytes or last eight bytes of the metadata is the protection information.</p>										

5.11.1 Command Completion

A completion queue entry is posted to the Admin Completion Queue if the Identify data structure has been transferred to the memory buffer indicated in PRP Entry 1.

5.12 Set Features command

The Set Features command specifies the attributes of the Feature indicated.

The Set Features command uses the PRP Entry 1, PRP Entry 2, Command Dword 10, and Command Dword 11 fields. All other command specific fields are reserved.

Figure 86: Set Features – PRP Entry 1

Bit	Description
63:00	<p>PRP Entry 1 (PRP1): Indicates a data buffer that the Feature information is provided in if the Feature information is specified in a data structure. The buffer shall not have more than one physical discontinuity. If no data structure is used as part of the specified feature, then this field is not used.</p>

Figure 87: Set Features – PRP Entry 2

Bit	Description
63:00	<p>PRP Entry 2 (PRP2): This field contains the second PRP entry that specifies the location where data should be transferred from (if there is a physical discontinuity). This field shall not be a pointer to a PRP List. If no data structure is used as part of the specified feature, then this field is not used.</p>

Figure 88: Set Features – Command Dword 10

Bit	Description
31	<p>Save (SV): This field specifies that the controller shall save the attribute so that the attribute persists thru all power states and resets.</p> <p>The controller indicates in bit 4 of the Optional NVM Command Support field of the Identify Controller Data structure in Figure 82 whether this field is supported.</p> <p>If the Feature Identifier specified in the Set Features command is not saveable by the controller and the controller receives a Set Features command with the Save bit set to one, then the command shall be aborted with a status of Feature Identifier Not Saveable.</p>
30:08	Reserved
07:00	Feature Identifier (FID): This field indicates the identifier of the Feature that attributes are being specified for.

5.12.1 Feature Specific Information

Figure 89 defines the Features that may be configured with Set Features and retrieved with Get Features. Figure 90 defines Features that are specific to the NVM Command Set. Some Features utilize a memory buffer to configure or return attributes for a Feature, whereas others only utilize a Dword in the command or completion queue entry. Feature values that are not persistent across power states are reset to their default values as part of a controller reset operation. The default value for each Feature is vendor specific and is not changeable; it is set by the manufacturer. For more information on Features, including default, saveable, and current value definitions, refer to section 7.7.

There may be commands in execution when a Feature is changed. The new settings may or may not apply to commands already submitted for execution when the Feature is changed. Any commands submitted to a Submission Queue after a Set Features is successfully completed shall utilize the new settings for the associated Feature. To ensure that a Feature applies to all subsequent commands, commands being processed should be completed prior to issuing the Set Features command.

Figure 89: Set Features – Feature Identifiers

Feature Identifier	O/M	Persistent Across Power States and Reset ²	Uses Memory Buffer for Attributes	Description
00h				Reserved
01h	M	No	No	Arbitration
02h	M	No	No	Power Management
03h	O	Yes	Yes	LBA Range Type
04h	M	No	No	Temperature Threshold
05h	M	No	No	Error Recovery
06h	O	No	No	Volatile Write Cache
07h	M	No	No	Number of Queues
08h	M	No	No	Interrupt Coalescing
09h	M	No	No	Interrupt Vector Configuration
0Ah	M	No	No	Write Atomicity
0Bh	M	No	No	Asynchronous Event Configuration
0Ch	O	No	Yes	Autonomous Power State Transition
0Dh – 7Fh				Reserved
80h – BFh				Command Set Specific (Reserved)
C0h – FFh				Vendor Specific ¹
NOTES:				
1. The behavior of a controller in response to an inactive namespace ID to a vendor specific Feature Identifier is vendor specific.				
2. This column is only valid if bit 4 in the Optional NVM Command Support field of the Identify Controller Data structure in Figure 82 is cleared to '0'.				

O/M: O = Optional, M = Mandatory

Figure 90: Set Features, NVM Command Set Specific – Feature Identifiers

Feature Identifier	O/M	Persistent Across Power States and Reset ¹	Uses Memory Buffer for Attributes	Description
80h	O	Yes	No	Software Progress Marker
81h	O ²	No	Yes	Host Identifier
82h	O ³	No	No	Reservation Notification Mask
83h	O ³	Yes	No	Reservation Persistence
84h – BFh				Reserved

NOTES:

1. This column is only valid if bit 4 in the Optional NVM Command Support field of the Identify Controller Data structure in Figure 82 is cleared to '0'.
2. Mandatory if reservations are supported as indicated in the Identify Controller data structure.
3. Mandatory if reservations are supported by the namespace as indicated by a non-zero value in the Reservation Capabilities (RESCAP) field in the Identify Namespace data structure.

O/M: O = Optional, M = Mandatory

5.12.1.1 Arbitration (Feature Identifier 01h)

This Feature controls command arbitration. Refer to section 4.8 for command arbitration details. The attributes are indicated in Command Dword 11.

If a Get Features command is submitted for this Feature, the attributes specified in Figure 91 are returned in Dword 0 of the completion queue entry for that command.

Figure 91: Arbitration & Command Processing – Command Dword 11

Bit	Description
31:24	High Priority Weight (HPW): This field defines the number of commands that may be executed from the high priority service class in each arbitration round. This is a 0's based value.
23:16	Medium Priority Weight (MPW): This field defines the number of commands that may be executed from the medium priority service class in each arbitration round. This is a 0's based value.
15:08	Low Priority Weight (LPW): This field defines the number of commands that may be executed from the low priority service class in each arbitration round. This is a 0's based value.
07:03	Reserved
02:00	Arbitration Burst (AB): Indicates the maximum number of commands that the controller may launch at one time from a particular Submission Queue. This value is specified as 2 ⁿ . A value of 111b indicates no limit. Thus, the possible settings are 1, 2, 4, 8, 16, 32, 64, or no limit.

5.12.1.2 Power Management (Feature Identifier 02h)

This Feature allows the host to configure the power state. The attributes are indicated in Command Dword 11.

If a Get Features command is submitted for this Feature, the attributes specified in Figure 92 are returned in Dword 0 of the completion queue entry for that command.

Figure 92: Power Management – Command Dword 11

Bit	Description
31:05	Reserved
04:00	Power State (PS): This field indicates the new power state into which the controller should transition. This power state shall be one supported by the controller as indicated in the Number of Power States Supported (NPSS) field in the Identify Controller data structure. The behavior of transitioning to a power state not supported by the controller is undefined.

5.12.1.3 LBA Range Type (Feature Identifier 03h), (Optional)

This feature indicates the type and attributes of LBA ranges that are part of the specified namespace. The LBA range information may be used by a driver to determine if it may utilize a particular LBA range; the information is not exposed to higher level software.

This is optional information that is not required for proper behavior of the system. However, it may be utilized to avoid unintended software issues. For example, if the LBA range indicates that it is a RAID volume then a driver that does not have RAID functionality should not utilize that LBA range (including not overwriting the LBA range). The optional information may be utilized by the driver to determine whether the LBA Range should be exposed to higher level software.

The LBA Range Type uses Command Dword 11 and specifies the type and attribute information in the data structure indicated in Figure 94. The data structure is 4096 bytes in size and shall be physically contiguous.

If a Get Features command is submitted for this Feature, the attributes specified in Figure 93 are returned in Dword 0 of the completion queue entry and the LBA Range Type data structure specified in Figure 94 is returned in the data buffer for that command.

Figure 93: LBA Range Type – Command Dword 11

Bit	Description
31:06	Reserved
05:00	Number of LBA Ranges (NUM): This field specifies the number of LBA ranges specified in this command. This is a 0's based value.

Each entry in the LBA Range Type data structure is defined in Figure 94. The LBA Range feature is a set of 64 byte entries; the number of entries is indicated as a command parameter, the maximum number of entries is 64. The LBA ranges shall not overlap. All unused entries in the LBA Range Type data structure shall be cleared to all zeroes.

Figure 94: LBA Range Type – Data Structure Entry

Byte	Description																
00	Type (Type): Specifies the Type of the LBA range. The Types are listed below.																
	<table border="1"> <thead> <tr> <th>Value</th> <th>Description</th> </tr> </thead> <tbody> <tr> <td>00h</td> <td>Reserved</td> </tr> <tr> <td>01h</td> <td>Filesystem</td> </tr> <tr> <td>02h</td> <td>RAID</td> </tr> <tr> <td>03h</td> <td>Cache</td> </tr> <tr> <td>04h</td> <td>Page / swap file</td> </tr> <tr> <td>05h – 7Fh</td> <td>Reserved</td> </tr> <tr> <td>80h - FFh</td> <td>Vendor Specific</td> </tr> </tbody> </table>	Value	Description	00h	Reserved	01h	Filesystem	02h	RAID	03h	Cache	04h	Page / swap file	05h – 7Fh	Reserved	80h - FFh	Vendor Specific
	Value	Description															
	00h	Reserved															
	01h	Filesystem															
	02h	RAID															
	03h	Cache															
	04h	Page / swap file															
05h – 7Fh	Reserved																
80h - FFh	Vendor Specific																
Attributes: Specifies attributes of the LBA range. Each bit defines an attribute.																	
<table border="1"> <thead> <tr> <th>Bit</th> <th>Description</th> </tr> </thead> <tbody> <tr> <td>0</td> <td>If set to '1', the LBA range may be overwritten. If cleared to '0', the area should not be overwritten.</td> </tr> <tr> <td>1</td> <td>If set to '1', the LBA range should be hidden from the OS / EFI / BIOS. If cleared to '0', the area should be visible to the OS / EFI / BIOS.</td> </tr> <tr> <td>2 – 7</td> <td>Reserved</td> </tr> </tbody> </table>	Bit	Description	0	If set to '1', the LBA range may be overwritten. If cleared to '0', the area should not be overwritten.	1	If set to '1', the LBA range should be hidden from the OS / EFI / BIOS. If cleared to '0', the area should be visible to the OS / EFI / BIOS.	2 – 7	Reserved									
Bit	Description																
0	If set to '1', the LBA range may be overwritten. If cleared to '0', the area should not be overwritten.																
1	If set to '1', the LBA range should be hidden from the OS / EFI / BIOS. If cleared to '0', the area should be visible to the OS / EFI / BIOS.																
2 – 7	Reserved																
15:02	Reserved																
23:16	Starting LBA (SLBA): This field specifies the 64-bit address of the first logical block that is part of this LBA range.																
31:24	Number of Logical Blocks (NLB): This field specifies the number of logical blocks that are part of this LBA range. This is a 0's based value.																
47:32	Unique Identifier (GUID): This field is a global unique identifier that uniquely specifies the type of this LBA range. Well known Types may be defined and are published on the NVM Express website.																
63:48	Reserved																

The host storage driver should expose all LBA ranges that are not set to be hidden from the OS / EFI / BIOS in the Attributes field. All LBA ranges that follow a hidden range shall also be hidden; the host storage driver should not expose subsequent LBA ranges that follow a hidden LBA range.

5.12.1.4 Temperature Threshold (Feature Identifier 04h)

This Feature indicates the threshold for the temperature of the overall device (controller and NVM included) in units of Kelvin. If this temperature is exceeded, then an asynchronous event may be issued to the host. The host should configure this feature prior to enabling asynchronous event notification for the temperature exceeding the threshold. The attributes are indicated in Command Dword 11.

If a Get Features command is submitted for this Feature, the attributes specified in Figure 95 are returned in Dword 0 of the completion queue entry for that command.

Figure 95: Temperature Threshold – Command Dword 11

Bit	Description
31:16	Reserved
15:00	Temperature Threshold (TMPH): Indicates the threshold for the temperature of the overall device (controller and NVM included) in units of Kelvin.

5.12.1.5 Error Recovery (Feature Identifier 05h)

This Feature controls the error recovery attributes. The attributes are indicated in Command Dword 11.

If a Get Features command is submitted for this Feature, the attributes specified in Figure 96 are returned in Dword 0 of the completion queue entry for that command.

Figure 96: Error Recovery – Command Dword 11

Bit	Description
31:16	Reserved
15:00	Time Limited Error Recovery (TLER): Indicates a limited retry timeout value in 100 millisecond units. This applies to I/O (e.g. Read, Write, etc) commands that indicate a time limit is required. A value of 0h indicates that there is no timeout.

5.12.1.6 Volatile Write Cache (Feature Identifier 06h), (Optional)

This Feature controls the volatile write cache, if present, on the controller. If a volatile write cache is supported, then this feature shall be supported. The attributes are indicated in Command Dword 11.

Note: If the controller is able to guarantee that data present in a write cache is written to non-volatile media on loss of power, then that write cache is considered non-volatile and this setting does not apply to that write cache. In that case, this setting has no effect.

If a Get Features command is submitted for this Feature, the attributes specified in Figure 97 are returned in Dword 0 of the completion queue entry for that command.

Figure 97: Volatile Write Cache – Command Dword 11

Bit	Description
31:01	Reserved
00	Volatile Write Cache Enable (WCE): If set to '1', then the volatile write cache is enabled. If cleared to '0', then the volatile write cache is disabled.

5.12.1.7 Number of Queues (Feature Identifier 07h)

This Feature indicates the number of queues that the host requests for this controller. This feature shall only be issued during initialization prior to creation of any I/O Submission and/or Completion Queues. The value allocated shall not change between resets. The attributes are indicated in Command Dword 11.

If a Get Features command is submitted for this Feature, the attributes specified in Figure 99 are returned in Dword 0 of the completion queue entry for that command.

Figure 98: Number of Queues – Command Dword 11

Bit	Description
31:16	Number of I/O Completion Queues Requested (NCQR): Indicates the number of I/O Completion Queues requested by software. This number does not include the Admin Completion Queue. A minimum of one shall be requested, reflecting that the minimum support is for one I/O Completion Queue. This is a 0's based value.
15:00	Number of I/O Submission Queues Requested (NSQR): Indicates the number of I/O Submission Queues requested by software. This number does not include the Admin Submission Queue. A minimum of one shall be requested, reflecting that the minimum support is for one I/O Submission Queue. This is a 0's based value.

The number of queues allocated is returned in Dword 0 of the command completion queue entry. The definition is shown in Figure 99.

Note: The value allocated may be smaller or larger than the number of queues requested, often in virtualized implementations. The controller may not have as many queues to allocate as are requested. Alternatively, the controller may have an allocation unit of queues (e.g. power of two) and may supply more queues to host software to satisfy its allocation unit.

Figure 99: Number of Queues – Dword 0 of command completion queue entry

Bit	Description
31:16	Number of I/O Completion Queues Allocated (NCQA): Indicates the number of I/O Completion Queues allocated by the controller. A minimum of one shall be allocated, reflecting that the minimum support is for one I/O Completion Queue. The value may not match the number requested by host software. This is a 0's based value.
15:00	Number of I/O Submission Queues Allocated (NSQA): Indicates the number of I/O Submission Queues allocated by the controller. A minimum of one shall be allocated, reflecting that the minimum support is for one I/O Submission Queue. The value may not match the number requested by host software. This is a 0's based value.

5.12.1.8 Interrupt Coalescing (Feature Identifier 08h)

This Feature configures interrupt coalescing settings. This Feature applies only to the I/O Queues. It is recommended that interrupts for commands that complete in error are not coalesced. The settings are specified in Command Dword 11.

The controller may delay an interrupt if it detects that interrupts are already being processed for this vector. Specifically, if the Completion Queue Head Doorbell register is being updated that is associated with a particular interrupt vector, then the controller has a positive indication that completion queue entries are already being processed. In this case, the aggregation time and/or the aggregation threshold may be reset/restarted upon the associated register write. This may result in interrupts being delayed indefinitely in certain workloads where the aggregation time or aggregation threshold are non-zero.

If a Get Features command is submitted for this Feature, the attributes specified in Figure 100 are returned in Dword 0 of the completion queue entry for that command.

Figure 100: Interrupt Coalescing – Command Dword 11

Bit	Description
31:16	Reserved
15:08	Aggregation Time (TIME): Specifies the recommended maximum time in 100 microsecond increments that a controller may delay an interrupt due to interrupt coalescing. A value of 0h corresponds to no delay (i.e., disabling this capability). The controller may apply this time per interrupt vector or across all interrupt vectors. The reset value of this setting is 0h.
07:00	Aggregation Threshold (THR): Specifies the desired minimum number of completion queue entries to aggregate per interrupt vector before signaling an interrupt to the host. This is a 0's based value. The reset value of this setting is 0h.

5.12.1.9 Interrupt Vector Configuration (Feature Identifier 09h)

This Feature configures settings specific to a particular interrupt vector. The settings are specified in Command Dword 11.

By default, coalescing settings are enabled for each interrupt vector. Interrupt coalescing is not supported for the Admin Completion Queue.

If a Get Features command is submitted for this Feature, the attributes specified in Figure 101 are returned in Dword 0 of the completion queue entry for that command for the Interrupt Vector specified in Command Dword 11..

Figure 101: Interrupt Vector Configuration – Command Dword 11

Bit	Description
31:17	Reserved
16	Coalescing Disable (CD): If set to '1', then any interrupt coalescing settings shall not be applied for this interrupt vector. If cleared to '0', then interrupt coalescing settings apply for this interrupt vector.
15:00	Interrupt Vector (IV): This field specifies the interrupt vector for which the configuration settings are applied.

5.12.1.10 Write Atomicity (Feature Identifier 0Ah)

This Feature controls write atomicity. The attributes are indicated in Command Dword 11.

If a Get Features command is submitted for this Feature, the attributes specified in Figure 102 are returned in Dword 0 of the completion queue entry for that command.

Figure 102: Write Atomicity – Command Dword 11

Bit	Description
31:01	Reserved
00	Disable Normal (DN): If set to '1', then the host specifies that the atomic write unit for normal operation is not required and that the controller shall only honor the atomic write unit for power fail operations. If cleared to '0', the atomic write unit for normal operation shall be honored by the controller.

5.12.1.11 Asynchronous Event Configuration (Feature Identifier 0Bh)

This Feature controls the events that trigger an asynchronous event notification to the host. The attributes are indicated in Command Dword 11.

If a Get Features command is submitted for this Feature, the attributes specified in Figure 103 are returned in Dword 0 of the completion queue entry for that command.

Figure 103: Asynchronous Event Configuration – Command Dword 11

Bit	Description
31:08	Reserved
07:00	SMART / Health Critical Warnings: This field determines whether an asynchronous event notification is sent to the host for the corresponding Critical Warning specified in the SMART / Health Information Log (refer to Figure 75). If a bit is set to '1', then an asynchronous event notification is sent when the corresponding critical warning bit is set to '1' in the SMART / Health Information Log. If a bit is cleared to '0', then an asynchronous event notification is not sent when the corresponding critical warning bit is set to '1' in the SMART / Health Information Log.

5.12.1.12 Autonomous Power State Transition (Feature Identifier 0Ch), (Optional)

This feature configures the settings for autonomous power state transitions, refer to section 8.4.1.

The Autonomous Power State Transition uses Command Dword 11 and specifies the type and attribute information in the data structure indicated in Figure 104. The data structure is 256 bytes in size and shall be physically contiguous.

If a Get Features command is issued for this Feature, the attributes specified in Figure 104 are returned in Dword 0 of the completion queue entry and the Autonomous Power State Transition data structure, whose entry structure is defined in Figure 105 is returned in the data buffer for that command.

Figure 104: Autonomous Power State Transition – Command Dword 11

Bit	Description
31:01	Reserved
00	Autonomous Power State Transition Enable (APSTE): This field specifies whether autonomous power state transition is enabled. If this field is set to '1', then autonomous power state transitions are enabled. If this field is cleared to '0', then autonomous power state transitions are disabled. This field is cleared to '0' by default.

Each entry in the Autonomous Power State Transition data structure is defined in Figure 105. Each entry is 64 bits in size. There is an entry for each of the allowable 32 power states. For power states that are not supported, the unused Autonomous Power State Transition data structure entries shall be cleared to all zeroes. The entries begin with power state 0 and then increase sequentially (i.e., power state 0 is described in bytes 7:0, power state 1 is described in bytes 15:8, etc).

Figure 105: Autonomous Power State Transition – Data Structure Entry

Bit	Description
63:32	Reserved
31:08	Idle Time Prior to Transition (ITPT): This field specifies the amount of idle time that occurs in this power state prior to transitioning to the Idle Transition Power State. The time is specified in milliseconds. A value of 0h disables the autonomous power state transition feature for this power state.
07:03	Idle Transition Power State (ITPS): This field specifies the power state for the controller to autonomously transition to after there is a continuous period of idle time in the current power state that exceeds time specified in the Idle Time Prior to Transition field. The field specified is required to be a non-operational state as described in Figure 83.
02:00	Reserved

5.12.1.13 Software Progress Marker (Feature Identifier 80h), (Optional) – NVM Command Set Specific

This Feature is a software progress marker. The software progress marker is persistent across power states. For additional details, refer to section 7.6.1.1. This information may be used to indicate to an OS software driver whether there have been issues with the OS successfully loading. The attributes are indicated in Command Dword 11.

If a Get Features command is submitted for this Feature, the attributes specified in Figure 106 are returned in Dword 0 of the completion queue entry for that command.

Figure 106: Software Progress Marker – Command Dword 11

Bit	Description
31:08	Reserved
07:00	Pre-boot Software Load Count (PBSLC): Indicates the load count of pre-boot software. After successfully loading and initializing the controller, pre-boot software should set this field to one more than the previous value of the Pre-boot Software Load Count. If the previous value is 255 then the value should not be updated by pre-boot software (i.e., the value does not wrap to 0). OS driver software should set this field to 0h after the OS has successfully been initialized.

5.12.1.14 Host Identifier (Feature Identifier 81h), (Optional)¹

This feature allows the host to register a Host Identifier with the controller. The Host Identifier is used by the controller to determine whether other controllers in the NVM Subsystem are associated with the same host and is only required to be initialized if reservations are supported (refer to section 8.8). The Host Identifier value of zero is a special value that indicates that the host associated with the controller is not associated with any other controller in the NVM Subsystem.

The Host Identifier is contained in the data structure indicated in Figure 107. The Host Identifier may be modified at any time causing the controller to be logically remapped from the original host associated with the old Host Identifier to a new host associated with the new Host Identifier.

If a Get Features command is issued for this Feature, the data structure specified in Figure 107 is returned in the data buffer for that command.

Figure 107: Host Identifier – Data Structure Entry

Byte	Description
07:00	Host Identifier (HOSTID): This field specifies a 64-bit identifier that uniquely identifies the host associated with the controller within the NVM Subsystem. The value of the host identifier used by a host, the method used to select this value, and the method used to ensure uniqueness are outside the scope of this specification. Controllers in an NVM Subsystem that have the same Host Identifier are assumed to be associated with the same host and have the same reservation and registration rights. A Host Identifier value of zero indicates that the host is not associated with any other controller in the NVM Subsystem.

5.12.1.15 Reservation Notification Mask (Feature Identifier 82h), (Optional)²

This Feature controls the masking of reservation notifications on a per namespace basis. A Reservation Notification log page is created whenever a reservation notification occurs on a namespace and the corresponding reservation notification type is not masked on that namespace by this Feature. If reservations are supported by the controller, then this Feature shall be supported. The attributes are indicated in Command Dword 11.

A Set Features command that uses a namespace ID other than FFFFFFFFh modifies the reservation notification mask for the corresponding namespace only. A Set Features command that uses a namespace ID of FFFFFFFFh modifies the reservation notification mask of all namespaces that are accessible by the controller and that support reservations. A Get Features command that uses a

¹ Mandatory if reservations are supported as indicated in the Identify Controller data structure.

² Mandatory if reservations are supported by the namespace as indicated by a non-zero value in the

² Mandatory if reservations are supported by the namespace as indicated by a non-zero value in the Reservation Capabilities (RESCAP) field in the Identify Namespace data structure.

namespace ID other than FFFFFFFFh returns the reservation notification mask for the corresponding namespace. A Get Features command that uses a namespace ID of FFFFFFFFh is aborted with status Invalid Field in Command. If a Set Features or Get Features attempts to access the Reservation Notification Mask on a namespace that does not support reservations or is invalid, then the command is aborted with status Invalid Field in Command.

If a Get Features command successfully completes for this Feature, the attributes specified in Figure 108 are returned in Dword 0 of the completion queue entry for that command.

Figure 108: Reservation Notification Configuration – Command Dword 11

Bit	Description
31:04	Reserved
03	Mask Reservation Preempted Notification (RESPRE): If set to '1', then mask the reporting of reservation preempted notification by the controller. If cleared to '0', then the notification is not masked and a Reservation Notification log page is created whenever notification occurs.
02	Mask Reservation Released Notification (RESREL): If set to '1', then mask the reporting of reservation released notification by the controller. If cleared to '0', then the notification is not masked and a Reservation Notification log page is created whenever notification occurs.
01	Mask Registration Preempted Notification (REGPRE): If set to '1', then mask the reporting of registration preempted notification by the controller. If cleared to '0', then the notification is not masked and a Reservation Notification log page is created whenever the notification occurs.
00	Reserved

5.12.1.16 Reservation Persistence (Feature Identifier 83h), (Optional)³

Each namespace that supports reservations has a Persist Through Power Loss (PTPL) state that may be modified using either a Set Features command or a Reservation Register command (refer to section 6.10). The Reservation Persistence feature attributes are indicated in Command Dword 11.

The PTPL state is contained in the Reservation Persistence Feature that is namespace specific. A Set Features command that uses the namespace ID FFFFFFFFh modifies the PTPL state associated with all namespaces that are accessible by the controller and that support PTPL (i.e., support reservations). A Set Features command that uses a valid namespace ID other than FFFFFFFFh and corresponds to a namespace that supports reservations, modifies the PTPL state for that namespace. A Get Features command that uses a namespace ID of FFFFFFFFh is aborted with status Invalid Field in Command. A Get Features command that uses a valid namespace ID other than FFFFFFFFh and corresponds to a namespace that supports PTPL, returns the PTPL state for that namespace. If a Set Features or Get Features command using a namespace ID other than FFFFFFFFh attempts to access the PTPL state for a namespace that does not support this Feature Identifier, then the command is aborted with status Invalid Field in Command.

If a Get Features command successfully completes for this Feature Identifier, the attributes specified in Figure 109 are returned in Dword 0 of the completion queue entry for that command

Figure 109: Reservation Persistence Configuration – Command Dword 11

Bit	Description
31:01	Reserved
00	Persist Through Power Loss (PTPL): If set to '1', then reservations and registrants persist across a power loss. If cleared to '0', then reservations are released and registrants are cleared on a power loss.

³ Mandatory if reservations are supported by the namespace as indicated by a non-zero value in the Reservation Capabilities (RESCAP) field in the Identify Namespace data structure.

5.12.2 Command Completion

A completion queue entry is posted to the Admin Completion Queue when the controller has completed setting attributes associated with the Feature. Set Features command specific status values are defined in Figure 110.

Figure 110: Set Features – Command Specific Status Values

Value	Description
0Dh	Feature Identifier Not Saveable: The Feature Identifier specified does not support a saveable value.
0Eh	Feature Not Changeable: The Feature Identifier specified may not be changed.
0Fh	Feature Not Namespace Specific: The Feature Identifier specified is not namespace specific. The Feature Identifier settings apply across all namespaces.

5.13 Format NVM command – NVM Command Set Specific

The Format NVM command is used to low level format the NVM media. This is used when the host wants to change the LBA data size and/or metadata size. A low level format may destroy all data and metadata associated with all namespaces or only the specific namespace associated with the command (refer to the Format NVM Attributes field in the Identify Controller data structure).

As part of the Format NVM command, the host may request a secure erase of the contents of the NVM. There are two types of secure erase. The User Data Erase erases all user content present in the NVM subsystem. The Cryptographic Erase erases all user content present in the NVM subsystem by deleting the encryption key with which the user data was previously encrypted. The secure erase functionality may apply to all namespaces or may be specific to a particular namespace, refer to the Identify Controller data structure.

The Format NVM command shall fail if the controller is in an invalid security state. See the TCG SIIS reference.

The settings specified in the Format NVM command are reported as part of the Identify Namespace data structure.

If the controller supports multiple namespaces, then the host may specify the value of FFFFFFFFh for the namespace in order to apply the format operation to all namespaces regardless of the value of the Format NVM Attribute field in the Identify Controller data structure.

The Format NVM command uses the Command Dword 10 field. All other command specific fields are reserved.

Figure 111: Format NVM – Command Dword 10

Bit	Description												
31:12	Reserved												
11:09	<p>Secure Erase Settings (SES): This field specifies whether a secure erase should be performed as part of the format and the type of the secure erase operation. The erase applies to all user data, regardless of location (e.g., within an exposed LBA, within a cache, within deallocated LBAs, etc).</p> <table border="1"> <thead> <tr> <th>Value</th> <th>Definition</th> </tr> </thead> <tbody> <tr> <td>000b</td> <td>No secure erase operation requested</td> </tr> <tr> <td>001b</td> <td>User Data Erase: All user data shall be erased, contents of the user data after the erase is indeterminate (e.g., the user data may be zero filled, one filled, etc). The controller may perform a cryptographic erase when a User Data Erase is requested if all user data is encrypted.</td> </tr> <tr> <td>010b</td> <td>Cryptographic Erase: All user data shall be erased cryptographically. This is accomplished by deleting the encryption key.</td> </tr> <tr> <td>011b – 111b</td> <td>Reserved</td> </tr> </tbody> </table>	Value	Definition	000b	No secure erase operation requested	001b	User Data Erase: All user data shall be erased, contents of the user data after the erase is indeterminate (e.g., the user data may be zero filled, one filled, etc). The controller may perform a cryptographic erase when a User Data Erase is requested if all user data is encrypted.	010b	Cryptographic Erase: All user data shall be erased cryptographically. This is accomplished by deleting the encryption key.	011b – 111b	Reserved		
Value	Definition												
000b	No secure erase operation requested												
001b	User Data Erase: All user data shall be erased, contents of the user data after the erase is indeterminate (e.g., the user data may be zero filled, one filled, etc). The controller may perform a cryptographic erase when a User Data Erase is requested if all user data is encrypted.												
010b	Cryptographic Erase: All user data shall be erased cryptographically. This is accomplished by deleting the encryption key.												
011b – 111b	Reserved												
08	<p>Protection Information Location (PIL): If set to '1' and protection information is enabled, then protection information is transferred as the first eight bytes of metadata. If cleared to '0' and protection information is enabled, then protection information is transferred as the last eight bytes of metadata.</p>												
07:05	<p>Protection Information (PI): This field specifies whether end-to-end data protection is enabled and the type of protection information. The values for this field have the following meanings:</p> <table border="1"> <thead> <tr> <th>Value</th> <th>Definition</th> </tr> </thead> <tbody> <tr> <td>000b</td> <td>Protection information is not enabled</td> </tr> <tr> <td>001b</td> <td>Protection information is enabled, Type 1</td> </tr> <tr> <td>010b</td> <td>Protection information is enabled, Type 2</td> </tr> <tr> <td>011b</td> <td>Protection information is enabled, Type 3</td> </tr> <tr> <td>100b – 111b</td> <td>Reserved</td> </tr> </tbody> </table> <p>When end-to-end data protected is enabled, the host shall specify the appropriate protection information in the Read, Write, or Compare commands.</p>	Value	Definition	000b	Protection information is not enabled	001b	Protection information is enabled, Type 1	010b	Protection information is enabled, Type 2	011b	Protection information is enabled, Type 3	100b – 111b	Reserved
Value	Definition												
000b	Protection information is not enabled												
001b	Protection information is enabled, Type 1												
010b	Protection information is enabled, Type 2												
011b	Protection information is enabled, Type 3												
100b – 111b	Reserved												
04	<p>Metadata Settings (MS): This field is set to '1' if the metadata is transferred as part of an extended data LBA. This field is cleared to '0' if the metadata is transferred as part of a separate buffer. The metadata may include protection information, based on the Protection Information (PI) field.</p>												
03:00	<p>LBA Format (LBAF): This field specifies the LBA format to apply to the NVM media. This corresponds to the LBA formats indicated in the Identify command, refer to Figure 84 and Figure 85. Only supported LBA formats shall be selected.</p>												

5.13.1 Command Completion

A completion queue entry is posted to the Admin Completion Queue when the NVM media format is complete. Format NVM command specific status values are defined in Figure 112.

Figure 112: Format NVM – Command Specific Status Values

Value	Description
Ah	<p>Invalid Format: The format specified is invalid. This may be due to various conditions, including:</p> <ol style="list-style-type: none"> 1) specifying an invalid LBA Format number, or 2) enabling protection information when there is not sufficient metadata per LBA, or 3) enabling metadata to be transferred as part of a separate buffer when there is no metadata supported as part of the format selected, or 4) invalid security state (refer to TCG SIIS), etc.

5.14 Security Receive command – NVM Command Set Specific

The Security Receive command transfers the status and data result of one or more Security Send commands that were previously submitted to the controller.

The association between a Security Receive command and previous Security Send commands is dependent on the Security Protocol. The format of the data to be transferred is dependent on the Security Protocol. Refer to SPC-4 for Security Protocol details.

Each Security Receive command returns the appropriate data corresponding to a Security Send command as defined by the rules of the Security Protocol. The Security Receive command data may not be retained if there is a loss of communication between the controller and host, or if a controller reset occurs.

The fields used are PRP Entry 1, PRP Entry 2, Command Dword 10, and Command Dword 11 fields. All other command specific fields are reserved.

Figure 113: Security Receive – PRP Entry 1

Bit	Description
63:00	PRP Entry 1 (PRP1): Specifies a data buffer that contains the security protocol information. The buffer shall not have more than one physical discontinuity.

Figure 114: Security Receive – PRP Entry 2

Bit	Description
63:00	PRP Entry 2 (PRP2): This field contains the second PRP entry that specifies the location where data should be transferred to (if there is a physical discontinuity). This field shall not be a pointer to a PRP List.

Figure 115: Security Receive – Command Dword 10

Bit	Description
31:24	Security Protocol (SECP): This field specifies the security protocol as defined in SPC-4. The controller shall fail the command with Invalid Parameter indicated if an unsupported value of the Security Protocol is specified.
23:08	SP Specific (SPSP): The value of this field is specific to the Security Protocol as defined in SPC-4.
07:00	Reserved

Figure 116: Security Receive – Command Dword 11

Bit	Description
31:00	Allocation Length (AL): The value of this field is specific to the Security Protocol as defined in SPC-4.

5.14.1 Command Completion

If the command is completed, then the controller shall post a completion queue entry to the Admin Completion Queue indicating the status for the command.

5.14.2 Security Protocol 00h

A Security Receive command with the Security Protocol field set to 00h shall return information about the security protocols supported by the controller. This command is used in the security discovery process and is not associated with a Security Send command. Refer to SPC-4 for the details of Security Protocol 00h and the SP Specific field.

5.15 Security Send command – NVM Command Set Specific

The Security Send command is used to transfer security protocol data to the controller. The data structure transferred to the controller as part of this command contains security protocol specific commands to be performed by the controller. The data structure transferred may also contain data or parameters associated with the security protocol commands. Status and data that is to be returned to the host for the security protocol commands submitted by a Security Send command are retrieved with the Security Receive command defined in section 5.14.

The association between a Security Send command and subsequent Security Receive command is Security Protocol field dependent as defined in SPC-4.

The fields used are PRP Entry 1, PRP Entry 2, Command Dword 10, and Command Dword 11 fields. All other command specific fields are reserved.

Figure 117: Security Send – PRP Entry 1

Bit	Description
63:00	PRP Entry 1 (PRP1): Specifies a data buffer that contains the security protocol information. The buffer shall not have more than one physical discontinuity and shall be 4KB minimum in size.

Figure 118: Security Send – PRP Entry 2

Bit	Description
63:00	PRP Entry 2 (PRP2): This field contains the second PRP entry that specifies the location where data should be transferred from (if there is a physical discontinuity). This field shall not be a pointer to a PRP List.

Figure 119: Security Send – Command Dword 10

Bit	Description
31:24	Security Protocol (SECP): This field specifies the security protocol as defined in SPC-4. The controller shall fail the command with Invalid Parameter indicated if a reserved value of the Security Protocol is specified.
23:08	SP Specific (SPSP): The value of this field is specific to the Security Protocol as defined in SPC-4.
07:00	Reserved

Figure 120: Security Send – Command Dword 11

Bit	Description
31:00	Transfer Length (TL): The value of this field is specific to the Security Protocol as defined in SPC-4.

5.15.1 Command Completion

If the command is completed, then the controller shall post a completion queue entry to the Admin Completion Queue indicating the status for the command.

6 NVM Command Set

The device is comprised of some number of controllers, where each controller is comprised of some number of namespaces, where each namespace is comprised of some number of logical blocks. A logical block is the smallest unit of data that may be read or written from the controller. The logical block data size, reported in bytes, is always a power of two. Logical block sizes may be 512 bytes, 1KB, 2KB, 4KB, 8KB, etc. Supported logical block sizes are reported in the Identify Namespace data structure.

The NVM Command Set includes the commands listed in Figure 121. The following subsections describe the definition for each of these commands. Commands shall only be submitted by the host when the controller is ready as indicated in the Controller Status register (CSTS.RDY) and after appropriate I/O Submission Queue(s) and I/O Completion Queue(s) have been created.

The Submission Queue Entry (SQE) structure and the fields that are common to all NVM commands are defined in section 4.2. The Completion Queue Entry (CQE) structure and the fields that are common to all NVM commands are defined in section 4.6. The command specific fields in the SQE and CQE structures for the NVM Command Set are defined in this section.

In the case of Compare, Read, and Write commands, the host may indicate whether a time limit should be applied to the operation by setting the Limited Retry (LR) field in the command. The time limit is specified in the Error Recovery feature, specified in section 5.12.1.5. If the host does not specify a time limit should be applied, then the controller should apply all error recovery means to complete the operation.

Figure 121: Opcodes for NVM Commands

Opcode (07)	Opcode (06:02)	Opcode (01:00)	Opcode ²	O/M ¹	Command ³
Standard Command	Function	Data Transfer			
0b	000 00b	00b	00h	M	Flush
0b	000 00b	01b	01h	M	Write
0b	000 00b	10b	02h	M	Read
0b	000 01b	00b	04h	O	Write Uncorrectable
0b	000 01b	01b	05h	O	Compare
0b	000 10b	00b	08h	O	Write Zeroes
0b	000 10b	01b	09h	O	Dataset Management
0b	000 11b	01b	0Dh	O ⁴	Reservation Register
0b	000 11b	10b	0Eh	O ⁴	Reservation Report
0b	001 00b	01b	11h	O ⁴	Reservation Acquire
0b	001 01b	01b	15h	O ⁴	Reservation Release
Vendor Specific					
1b	na	na	80h – FFh	O	Vendor specific

NOTES:

- O/M definition: O = Optional, M = Mandatory.
- Opcodes not listed are reserved.
- All NVM commands use the Namespace Identifier field (CDW1.NSID).
- Mandatory if reservations are supported as indicated in the Identify Controller data structure.

6.1 Namespaces

A namespace is a collection of logical blocks that range from 0 to the capacity of the namespace – 1. The number of namespaces present is reported in the Identify Controller data structure. Unless otherwise noted, specifying an inactive namespace ID in a command that uses the namespace ID shall cause the controller to abort the command with status Invalid Field in Command. Specifying an invalid namespace

ID in a command that uses the namespace ID shall cause the controller to abort the command with status Invalid Namespace or Format. Namespace IDs may change across power off conditions. However, it is recommended that namespace identifiers remain static in order to avoid issues with EFI or OS drivers fast discovery processes. The management (creation, deletion) of namespaces is outside the scope of this specification.

The Namespace Size field in the Identify Namespace data structure defines the total size of the namespace in logical blocks (LBA 0 through $n-1$). The Namespace Utilization field in the Identify Namespace data structure defines the number of logical blocks currently allocated in the namespace. The Namespace Capacity field in the Identify data structure defines the maximum number of logical blocks that may be allocated at one time as part of the namespace in a thin provisioning usage model. The following relationship holds: Namespace Size \geq Namespace Capacity \geq Namespace Utilization.

A namespace may or may not have a relationship to a Submission Queue; this relationship is determined by the host software implementation. The controller shall support access to any valid namespace from any I/O Submission Queue.

6.2 Fused Operations

The command sequences that may be used in a fused operation for the NVM Command Set are defined in Figure 122. Refer to section 4.7 for details on fused operations.

Figure 122: Supported Fused Operations

Command 1	Command 2	Fused Operation
Compare	Write	Compare and Write

6.2.1 Compare and Write

The Compare and Write fused operation compares the contents of the logical block(s) specified in the Compare command to the data stored at the indicated LBA range. If the compare is successful, then the LBA range is updated with the data provided in the Write command. If the Compare operation is not successful, then the Write operation is aborted with a status of Command Aborted due to Failed Fused Command and the contents in the LBA range are not modified. If the Write operation is not successful, the Compare operation completion status is unaffected.

Note: To ensure the Compare and Write is an atomic operation in a multi-host environment, host software should ensure that the size of a Compare and Write fused operation is no larger than the atomic write unit size. Controllers may abort a Compare and Write fused operation that is larger than the atomic write unit size.

6.3 Command Ordering Requirements and Atomic Write Unit

Except for commands that are part of a fused operation, each command is processed as an independent entity without reference to other commands submitted to the same I/O Submission Queue or to commands submitted to other I/O Submission Queues. Specifically, the controller is not responsible for checking the LBA of a Read or Write command to ensure any type of ordering between commands. For example, if a Read is submitted for LBA x and there is a Write also submitted for LBA x , there is no guarantee of the order of completion for those commands (the Read may finish first or the Write may finish first).

If there are ordering requirements between commands, host software or the associated application is required to enforce that ordering above the level of the controller.

The controller supports an atomic write unit. The atomic write unit is the size of write operation guaranteed to be written atomically to the medium with respect to other read or write operations. The controller supports a value for normal operation that is potentially different than during a power fail condition, as reported in the Identify Controller data structure. The host may indicate that the atomic write unit beyond a logical block size is not necessary by configuring the Write Atomicity feature, which may result in higher performance in some implementations.

After a write has completed, reads for that location which are subsequently submitted shall return the data from that write and not an older version of the data from a previous write.

6.4 End-to-end Protection Information

The commands that include data transfer may utilize end-to-end data protection. Within these commands, the protection information action and protection information check field is specified as defined in Figure 123.

Figure 123: Protection Information Field Definition

Bit	Description								
03	Protection Information Action (PRACT): The protection information action field indicates the action to take for the protection information. If this field is set to '1', the protection information is stripped (read) or inserted (write). If this field is cleared to '0', the protection information is passed. This field is only used if the namespace is formatted to use end-to-end protection information. Refer to section 8.3.								
02:00	<p>Protection Information Check (PRCHK): The protection information check field indicates the fields that need to be checked as part of end-to-end data protection processing. This field is only used if the namespace is formatted to use end-to-end protection information. Refer to section 8.3.</p> <table border="1"> <thead> <tr> <th>Bit</th> <th>Definition</th> </tr> </thead> <tbody> <tr> <td>02</td> <td>If set to '1' enables protection information checking of the Guard field. If cleared to '0', the Guard field is not checked.</td> </tr> <tr> <td>01</td> <td>If set to '1' enables protection information checking of the Application Tag field. If cleared to '0', the Application Tag field is not checked.</td> </tr> <tr> <td>00</td> <td>If set to '1' enables protection information checking of the Logical Block Reference Tag field. If cleared to '0', the Logical Block Reference Tag field is not checked.</td> </tr> </tbody> </table>	Bit	Definition	02	If set to '1' enables protection information checking of the Guard field. If cleared to '0', the Guard field is not checked.	01	If set to '1' enables protection information checking of the Application Tag field. If cleared to '0', the Application Tag field is not checked.	00	If set to '1' enables protection information checking of the Logical Block Reference Tag field. If cleared to '0', the Logical Block Reference Tag field is not checked.
Bit	Definition								
02	If set to '1' enables protection information checking of the Guard field. If cleared to '0', the Guard field is not checked.								
01	If set to '1' enables protection information checking of the Application Tag field. If cleared to '0', the Application Tag field is not checked.								
00	If set to '1' enables protection information checking of the Logical Block Reference Tag field. If cleared to '0', the Logical Block Reference Tag field is not checked.								

6.5 Compare command

The Compare command reads the logical blocks specified by the command from the medium and compares the data read to a comparison data buffer transferred as part of the command. If the data read from the controller and the comparison data buffer are equivalent with no mismatches, then the command completes successfully. If there is any mismatch, the command completes with error. If metadata is provided, then a comparison is also performed for the metadata.

The command uses Command Dword 10, Command Dword 11, Command Dword 12, Command Dword 14, and Command Dword 15 fields. If the command uses PRPs for the data transfer, then the Metadata Pointer, PRP Entry 1, and PRP Entry 2 fields are used. If the command uses SGLs for the data transfer, then the Metadata SGL Segment Pointer and SGL Entry 1 fields are used. All other command specific fields are reserved.

Figure 124: Compare – Metadata (SGL Segment) Pointer

Bit	Description		
63:00	If CDW0[15] is cleared to '0', then the definition of this field is: <table border="1" data-bbox="375 323 1360 384"> <tr> <td>63:00</td> <td>Metadata Pointer (MPTR): This field contains the address of a contiguous physical buffer of metadata, if applicable. This field shall be Dword aligned.</td> </tr> </table>	63:00	Metadata Pointer (MPTR): This field contains the address of a contiguous physical buffer of metadata, if applicable. This field shall be Dword aligned.
	63:00	Metadata Pointer (MPTR): This field contains the address of a contiguous physical buffer of metadata, if applicable. This field shall be Dword aligned.	
If CDW0[15] is set to '1', then the definition of this field is: <table border="1" data-bbox="375 464 1360 518"> <tr> <td>63:00</td> <td>Metadata SGL Segment Pointer (MSGLP): This field contains the address of an SGL segment that describes the metadata to transfer, if applicable.</td> </tr> </table>	63:00	Metadata SGL Segment Pointer (MSGLP): This field contains the address of an SGL segment that describes the metadata to transfer, if applicable.	
63:00	Metadata SGL Segment Pointer (MSGLP): This field contains the address of an SGL segment that describes the metadata to transfer, if applicable.		

Figure 125: Compare – PRP Entries or SGL Entry 1

Bit	Description				
127:00	If CDW0[15] is cleared to '0', then the definition of this field is: <table border="1" data-bbox="370 720 1365 915"> <tr> <td>127:64</td> <td>PRP Entry 2 (PRP2): This field contains the second PRP entry. If the data to compare is satisfied with PRP Entry 1, then this field is reserved. If the data to compare may be satisfied with two PRP entries total, then this entry specifies the location that should be used for comparison. If the data transfer requires more than two PRP entries, then this field includes a pointer to a PRP List.</td> </tr> <tr> <td>63:00</td> <td>PRP Entry 1 (PRP1): This field contains the first PRP entry, indicating the location of data that should be used for comparison.</td> </tr> </table>	127:64	PRP Entry 2 (PRP2): This field contains the second PRP entry. If the data to compare is satisfied with PRP Entry 1, then this field is reserved. If the data to compare may be satisfied with two PRP entries total, then this entry specifies the location that should be used for comparison. If the data transfer requires more than two PRP entries, then this field includes a pointer to a PRP List.	63:00	PRP Entry 1 (PRP1): This field contains the first PRP entry, indicating the location of data that should be used for comparison.
	127:64	PRP Entry 2 (PRP2): This field contains the second PRP entry. If the data to compare is satisfied with PRP Entry 1, then this field is reserved. If the data to compare may be satisfied with two PRP entries total, then this entry specifies the location that should be used for comparison. If the data transfer requires more than two PRP entries, then this field includes a pointer to a PRP List.			
	63:00	PRP Entry 1 (PRP1): This field contains the first PRP entry, indicating the location of data that should be used for comparison.			
If CDW0[15] is set to '1', then the definition of this field is: <table border="1" data-bbox="370 999 1365 1054"> <tr> <td>127:00</td> <td>SGL Entry 1 (SGL1): This field contains the first SGL segment for the command, indicating the location of data that should be used for comparison.</td> </tr> </table>	127:00	SGL Entry 1 (SGL1): This field contains the first SGL segment for the command, indicating the location of data that should be used for comparison.			
127:00	SGL Entry 1 (SGL1): This field contains the first SGL segment for the command, indicating the location of data that should be used for comparison.				

Figure 126: Compare – Command Dword 10 and Command Dword 11

Bit	Description
63:00	Starting LBA (SLBA): This field specifies the 64-bit address of the first logical block to compare against as part of the operation. Command Dword 10 contains bits 31:00; Command Dword 11 contains bits 63:32.

Figure 127: Compare – Command Dword 12

Bit	Description
31	Limited Retry (LR): If set to '1', the controller should apply limited retry efforts. If cleared to '0', the controller should apply all available error recovery means to retrieve the data for comparison.
30	Force Unit Access (FUA): This field specifies that the data read shall be read from non-volatile media.
29:26	Protection Information Field (PRINFO): Specifies the protection information action and check field, as defined in Figure 123.
25:16	Reserved
15:00	Number of Logical Blocks (NLB): This field specifies the number of logical blocks to be compared. This is a 0's based value.

Figure 128: Compare – Command Dword 14

Bit	Description
31:00	Expected Initial Logical Block Reference Tag (EILBRT): This field specifies the Initial Logical Block Reference Tag expected value. This field is only used if the namespace is formatted to use end-to-end protection information. Refer to section 8.3.

Figure 129: Compare – Command Dword 15

Bit	Description
31:16	Expected Logical Block Application Tag Mask (ELBATM): This field specifies the Application Tag Mask expected value. This field is only used if the namespace is formatted to use end-to-end protection information. Refer to section 8.3.
15:00	Expected Logical Block Application Tag (ELBAT): This field specifies the Application Tag expected value. This field is only used if the namespace is formatted to use end-to-end protection information. Refer to section 8.3.

6.5.1 Command Completion

If the command is completed, then the controller shall post a completion queue entry to the associated I/O Completion Queue indicating the status for the command. If there are any mismatches between the data read from the NVM media and the data buffer provided, then the command fails with a status code of Compare Failure.

Compare command specific status values are defined in Figure 130.

Figure 130: Compare – Command Specific Status Values

Value	Description
81h	Invalid Protection Information: The Protection Information settings specified in the command are invalid.

6.6 Dataset Management command

The Dataset Management command is used by the host to indicate attributes for ranges of logical blocks. This includes attributes like frequency that data is read or written, access size, and other information that may be used to optimize performance and reliability. This command is advisory; a compliant device may choose to take no action based on information provided.

The command uses Command Dword 10, and Command Dword 11 fields. If the command uses PRPs for the data transfer, then the PRP Entry 1 and PRP Entry 2 fields are used. If the command uses SGLs for the data transfer, then the SGL Entry 1 field is used. All other command specific fields are reserved.

Figure 131: Dataset Management – PRP Entries or SGL Entry 1

Bit	Description				
127:00	If CDW0[15] is cleared to '0', then the definition of this field is:				
	<table border="1"> <tr> <td>127:64</td> <td>PRP Entry 2 (PRP2): This field contains the second PRP entry that specifies the location where data should be transferred from (if there is a physical discontinuity). This field shall not be a pointer to a PRP List.</td> </tr> <tr> <td>63:00</td> <td>PRP Entry 1 (PRP1): Indicates a data buffer that contains the LBA range information. The buffer shall not have more than one physical discontinuity.</td> </tr> </table>	127:64	PRP Entry 2 (PRP2): This field contains the second PRP entry that specifies the location where data should be transferred from (if there is a physical discontinuity). This field shall not be a pointer to a PRP List.	63:00	PRP Entry 1 (PRP1): Indicates a data buffer that contains the LBA range information. The buffer shall not have more than one physical discontinuity.
	127:64	PRP Entry 2 (PRP2): This field contains the second PRP entry that specifies the location where data should be transferred from (if there is a physical discontinuity). This field shall not be a pointer to a PRP List.			
63:00	PRP Entry 1 (PRP1): Indicates a data buffer that contains the LBA range information. The buffer shall not have more than one physical discontinuity.				
If CDW0[15] is set to '1', then the definition of this field is:					
127:00	SGL Entry 1 (SGL1): This field contains the first SGL segment for the command, indicating the location of a data buffer that contains the LBA range information.				

Figure 132: Dataset Management – Command Dword 10

Bit	Description
31:08	Reserved
07:00	Number of Ranges (NR): Indicates the number of 16 byte range sets that are specified in the command. This is a 0's based value.

Figure 133: Dataset Management – Command Dword 11

Bit	Description
31:03	Reserved
02	Attribute – Deallocate (AD): If set to '1' then the NVM subsystem may deallocate all provided ranges. If a read occurs to a deallocated range, the NVM Express subsystem shall return all zeros, all ones, or the last data written to the associated LBA.
01	Attribute – Integral Dataset for Write (IDW): If set to '1' then the dataset should be optimized for write access as an integral unit. The host expects to perform operations on all ranges provided as an integral unit for writes, indicating that if a portion of the dataset is written it is expected that all of the ranges in the dataset are going to be written.
00	Attribute – Integral Dataset for Read (IDR): If set to '1' then the dataset should be optimized for read access as an integral unit. The host expects to perform operations on all ranges provided as an integral unit for reads, indicating that if a portion of the dataset is read it is expected that all of the ranges in the dataset are going to be read.

The data that the Dataset Management command provides is a list of ranges with context attributes. Each range consists of a starting LBA, a length of logical blocks that the range consists of and the context attributes to be applied to that range. The definition of the Dataset Management command Range field is specified in Figure 134. The maximum case of 256 ranges is shown.

Figure 134: Dataset Management – Range Definition

Range	Byte	Field
Range 0	03:00	Context Attributes
	07:04	Length in logical blocks
	15:08	Starting LBA
Range 1	19:16	Context Attributes
	23:20	Length in logical blocks
	31:24	Starting LBA
...		
Range 255	4083:4080	Context Attributes
	4087:4084	Length in logical blocks
	4095:4088	Starting LBA

6.6.1 Context Attributes

The context attributes specified for each range provides information about how the range is intended to be used by host software. The use of this information is optional and the controller is not required to perform any specific action.

Note: The controller is required to maintain the integrity of data on the NVM media regardless of whether the attributes provided by host software are accurate.

Figure 135: Dataset Management – Context Attributes

Attribute	Bits	Description																
Command Access Size	31:24	Number of logical blocks expected to be transferred in a single Read or Write command from this dataset. A value of 0h indicates no Command Access Size is provided.																
Reserved	23:11	Reserved																
WP: Write Prepare	10	If set to '1' then the provided range is expected to be written in the near future.																
SW: Sequential Write Range	09	If set to '1' then the dataset should be optimized for sequential write access. The host expects to perform operations on the dataset as a single object for writes.																
SR: Sequential Read Range	08	If set to '1' then the dataset should be optimized for sequential read access. The host expects to perform operations on the dataset as a single object for reads.																
Reserved	07:06	Reserved																
AL: Access Latency	05:04	<table border="1"> <thead> <tr> <th>Value</th> <th>Definition</th> </tr> </thead> <tbody> <tr> <td>00b</td> <td>None. No latency information provided.</td> </tr> <tr> <td>01b</td> <td>Idle. Longer latency acceptable.</td> </tr> <tr> <td>10b</td> <td>Normal. Typical latency.</td> </tr> <tr> <td>11b</td> <td>Low. Smallest possible latency.</td> </tr> </tbody> </table>	Value	Definition	00b	None. No latency information provided.	01b	Idle. Longer latency acceptable.	10b	Normal. Typical latency.	11b	Low. Smallest possible latency.						
		Value	Definition															
		00b	None. No latency information provided.															
		01b	Idle. Longer latency acceptable.															
		10b	Normal. Typical latency.															
11b	Low. Smallest possible latency.																	
AF: Access Frequency	03:00	<table border="1"> <thead> <tr> <th>Value</th> <th>Definition</th> </tr> </thead> <tbody> <tr> <td>0000b</td> <td>No frequency information provided.</td> </tr> <tr> <td>0001b</td> <td>Typical number of reads and writes expected for this LBA range.</td> </tr> <tr> <td>0010b</td> <td>Infrequent writes and infrequent reads to the LBA range indicated.</td> </tr> <tr> <td>0011b</td> <td>Infrequent writes and frequent reads to the LBA range indicated.</td> </tr> <tr> <td>0100b</td> <td>Frequent writes and infrequent reads to the LBA range indicated.</td> </tr> <tr> <td>0101b</td> <td>Frequent writes and frequent reads to the LBA range indicated.</td> </tr> <tr> <td>0110b – 1111b</td> <td>Reserved</td> </tr> </tbody> </table>	Value	Definition	0000b	No frequency information provided.	0001b	Typical number of reads and writes expected for this LBA range.	0010b	Infrequent writes and infrequent reads to the LBA range indicated.	0011b	Infrequent writes and frequent reads to the LBA range indicated.	0100b	Frequent writes and infrequent reads to the LBA range indicated.	0101b	Frequent writes and frequent reads to the LBA range indicated.	0110b – 1111b	Reserved
		Value	Definition															
		0000b	No frequency information provided.															
		0001b	Typical number of reads and writes expected for this LBA range.															
		0010b	Infrequent writes and infrequent reads to the LBA range indicated.															
		0011b	Infrequent writes and frequent reads to the LBA range indicated.															
		0100b	Frequent writes and infrequent reads to the LBA range indicated.															
		0101b	Frequent writes and frequent reads to the LBA range indicated.															
0110b – 1111b	Reserved																	

6.6.1.1 Deallocate

An LBA that has been deallocated using the Dataset Management command is no longer deallocated when the LBA is written. Read operations do not affect the deallocation status of an LBA. The value read from a deallocated LBA shall be deterministic; specifically, the value returned by subsequent reads of that LBA shall be the same until a write occurs to that LBA. The values read from a deallocated LBA and its metadata (excluding protection information) shall be all zeros, all ones, or the last data written to the associated LBA and its metadata. The values read from an unwritten or deallocated LBA's protection information field shall be all ones (indicating the protection information shall not be checked).

Note: The operation of the Deallocate function is similar to the ATA DATA SET MANAGEMENT with Trim feature described in ACS-2 and SCSI UNMAP command described in SBC-3.

6.6.2 Command Completion

When the command is completed, the controller shall post a completion queue entry to the associated I/O Completion Queue indicating the status for the command.

Dataset Management command specific status values are defined in Figure 136.

Figure 136: Dataset Management – Command Specific Status Values

Value	Description
80h	Conflicting Attributes: The attributes specified in the command are conflicting.

6.7 Flush command

The Flush command is used by the host to indicate that any data in volatile storage should be flushed to non-volatile media.

All command specific fields are reserved.

6.7.1 Command Completion

If the command is completed, then the controller shall post a completion queue entry to the associated I/O Completion Queue indicating the status for the command.

6.8 Read command

The Read command reads data and metadata, if applicable, from the NVM controller for the LBAs indicated. The command may specify protection information to be checked as part of the read operation.

The command uses Command Dword 10, Command Dword 11, Command Dword 12, Command Dword 13, Command Dword 14, and Command Dword 15 fields. If the command uses PRPs for the data transfer, then the Metadata Pointer, PRP Entry 1, and PRP Entry 2 fields are used. If the command uses SGLs for the data transfer, then the Metadata SGL Segment Pointer and SGL Entry 1 fields are used.

Figure 137: Read – Metadata (SGL Segment) Pointer

Bit	Description		
63:00	If CDW0[15] is cleared to '0', then the definition of this field is: <table border="1" data-bbox="375 321 1360 384"> <tr> <td>63:00</td> <td>Metadata Pointer (MPTR): This field contains the address of a contiguous physical buffer of metadata. This field shall be Dword aligned.</td> </tr> </table>	63:00	Metadata Pointer (MPTR): This field contains the address of a contiguous physical buffer of metadata. This field shall be Dword aligned.
	63:00	Metadata Pointer (MPTR): This field contains the address of a contiguous physical buffer of metadata. This field shall be Dword aligned.	
If CDW0[15] is set to '1', then the definition of this field is: <table border="1" data-bbox="375 464 1360 527"> <tr> <td>63:00</td> <td>Metadata SGL Segment Pointer (MSGLP): This field contains the address of an SGL segment that describes the metadata to transfer.</td> </tr> </table>	63:00	Metadata SGL Segment Pointer (MSGLP): This field contains the address of an SGL segment that describes the metadata to transfer.	
63:00	Metadata SGL Segment Pointer (MSGLP): This field contains the address of an SGL segment that describes the metadata to transfer.		

Figure 138: Read – PRP Entries or SGL Entry 1

Bit	Description				
127:00	If CDW0[15] is cleared to '0', then the definition of this field is: <table border="1" data-bbox="370 720 1365 919"> <tr> <td>127:64</td> <td>PRP Entry 2 (PRP2): This field contains the second PRP entry. If the data transfer is satisfied with PRP Entry 1, then this field is reserved. If the data transfer may be satisfied with two PRP entries total, then this entry specifies the location where data should be transferred to. If the data transfer requires more than two PRP entries, then this field includes a pointer to a PRP List.</td> </tr> <tr> <td>63:00</td> <td>PRP Entry 1 (PRP1): This field contains the first PRP entry, indicating the location where data should be transferred to.</td> </tr> </table>	127:64	PRP Entry 2 (PRP2): This field contains the second PRP entry. If the data transfer is satisfied with PRP Entry 1, then this field is reserved. If the data transfer may be satisfied with two PRP entries total, then this entry specifies the location where data should be transferred to. If the data transfer requires more than two PRP entries, then this field includes a pointer to a PRP List.	63:00	PRP Entry 1 (PRP1): This field contains the first PRP entry, indicating the location where data should be transferred to.
	127:64	PRP Entry 2 (PRP2): This field contains the second PRP entry. If the data transfer is satisfied with PRP Entry 1, then this field is reserved. If the data transfer may be satisfied with two PRP entries total, then this entry specifies the location where data should be transferred to. If the data transfer requires more than two PRP entries, then this field includes a pointer to a PRP List.			
	63:00	PRP Entry 1 (PRP1): This field contains the first PRP entry, indicating the location where data should be transferred to.			
If CDW0[15] is set to '1', then the definition of this field is: <table border="1" data-bbox="370 999 1365 1062"> <tr> <td>127:00</td> <td>SGL Entry 1 (SGL1): This field contains the first SGL segment for the command, indicating the location where data should be transferred to.</td> </tr> </table>	127:00	SGL Entry 1 (SGL1): This field contains the first SGL segment for the command, indicating the location where data should be transferred to.			
127:00	SGL Entry 1 (SGL1): This field contains the first SGL segment for the command, indicating the location where data should be transferred to.				

Figure 139: Read – Command Dword 10 and Command Dword 11

Bit	Description
63:00	Starting LBA (SLBA): This field indicates the 64-bit address of the first logical block to be read as part of the operation. Command Dword 10 contains bits 31:00; Command Dword 11 contains bits 63: 32.

Figure 140: Read – Command Dword 12

Bit	Description
31	Limited Retry (LR): If set to '1', the controller should apply limited retry efforts. If cleared to '0', the controller should apply all available error recovery means to return the data to the host.
30	Force Unit Access (FUA): This field indicates that the data read shall be returned from non-volatile media. There is no implied ordering with other commands.
29:26	Protection Information Field (PRINFO): Specifies the protection information action and check field, as defined in Figure 123.
25:16	Reserved
15:00	Number of Logical Blocks (NLB): This field indicates the number of logical blocks to be read. This is a 0's based value.

Figure 141: Read – Command Dword 13

Bit	Description																																															
31:08	Reserved																																															
07:00	<p>Dataset Management (DSM): This field indicates attributes for the dataset that the LBA(s) being read are associated with.</p> <table border="1"> <thead> <tr> <th>Bits</th> <th>Attribute</th> <th>Definition</th> </tr> </thead> <tbody> <tr> <td>07</td> <td>Incompressible</td> <td>If set to '1', then data is not compressible for the logical blocks indicated. If cleared to '0', then no information on compression is provided.</td> </tr> <tr> <td>06</td> <td>Sequential Request</td> <td>If set to '1', then this command is part of a sequential read that includes multiple Read commands. If cleared to '0', then no information on sequential access is provided.</td> </tr> <tr> <td rowspan="4">05:04</td> <td rowspan="4">Access Latency</td> <td> <table border="1"> <thead> <tr> <th>Value</th> <th>Definition</th> </tr> </thead> <tbody> <tr> <td>00b</td> <td>None. No latency information provided.</td> </tr> <tr> <td>01b</td> <td>Idle. Longer latency acceptable.</td> </tr> <tr> <td>10b</td> <td>Normal. Typical latency.</td> </tr> <tr> <td>11b</td> <td>Low. Smallest possible latency.</td> </tr> </tbody> </table> </td> </tr> <tr> <td rowspan="10">03:00</td> <td rowspan="10">Access Frequency</td> <td> <table border="1"> <thead> <tr> <th>Value</th> <th>Definition</th> </tr> </thead> <tbody> <tr> <td>0000b</td> <td>No frequency information provided.</td> </tr> <tr> <td>0001b</td> <td>Typical number of reads and writes expected for this LBA range.</td> </tr> <tr> <td>0010b</td> <td>Infrequent writes and infrequent reads to the LBA range indicated.</td> </tr> <tr> <td>0011b</td> <td>Infrequent writes and frequent reads to the LBA range indicated.</td> </tr> <tr> <td>0100b</td> <td>Frequent writes and infrequent reads to the LBA range indicated.</td> </tr> <tr> <td>0101b</td> <td>Frequent writes and frequent reads to the LBA range indicated.</td> </tr> <tr> <td>0110b</td> <td>One time read. E.g. command is due to virus scan, backup, file copy, or archive.</td> </tr> <tr> <td>0111b</td> <td>Speculative read. The command is part of a prefetch operation.</td> </tr> <tr> <td>1000b</td> <td>The LBA range is going to be overwritten in the near future.</td> </tr> <tr> <td>1001b – 1111b</td> <td>Reserved</td> </tr> </tbody> </table> </td> </tr> </tbody> </table>	Bits	Attribute	Definition	07	Incompressible	If set to '1', then data is not compressible for the logical blocks indicated. If cleared to '0', then no information on compression is provided.	06	Sequential Request	If set to '1', then this command is part of a sequential read that includes multiple Read commands. If cleared to '0', then no information on sequential access is provided.	05:04	Access Latency	<table border="1"> <thead> <tr> <th>Value</th> <th>Definition</th> </tr> </thead> <tbody> <tr> <td>00b</td> <td>None. No latency information provided.</td> </tr> <tr> <td>01b</td> <td>Idle. Longer latency acceptable.</td> </tr> <tr> <td>10b</td> <td>Normal. Typical latency.</td> </tr> <tr> <td>11b</td> <td>Low. Smallest possible latency.</td> </tr> </tbody> </table>	Value	Definition	00b	None. No latency information provided.	01b	Idle. Longer latency acceptable.	10b	Normal. Typical latency.	11b	Low. Smallest possible latency.	03:00	Access Frequency	<table border="1"> <thead> <tr> <th>Value</th> <th>Definition</th> </tr> </thead> <tbody> <tr> <td>0000b</td> <td>No frequency information provided.</td> </tr> <tr> <td>0001b</td> <td>Typical number of reads and writes expected for this LBA range.</td> </tr> <tr> <td>0010b</td> <td>Infrequent writes and infrequent reads to the LBA range indicated.</td> </tr> <tr> <td>0011b</td> <td>Infrequent writes and frequent reads to the LBA range indicated.</td> </tr> <tr> <td>0100b</td> <td>Frequent writes and infrequent reads to the LBA range indicated.</td> </tr> <tr> <td>0101b</td> <td>Frequent writes and frequent reads to the LBA range indicated.</td> </tr> <tr> <td>0110b</td> <td>One time read. E.g. command is due to virus scan, backup, file copy, or archive.</td> </tr> <tr> <td>0111b</td> <td>Speculative read. The command is part of a prefetch operation.</td> </tr> <tr> <td>1000b</td> <td>The LBA range is going to be overwritten in the near future.</td> </tr> <tr> <td>1001b – 1111b</td> <td>Reserved</td> </tr> </tbody> </table>	Value	Definition	0000b	No frequency information provided.	0001b	Typical number of reads and writes expected for this LBA range.	0010b	Infrequent writes and infrequent reads to the LBA range indicated.	0011b	Infrequent writes and frequent reads to the LBA range indicated.	0100b	Frequent writes and infrequent reads to the LBA range indicated.	0101b	Frequent writes and frequent reads to the LBA range indicated.	0110b	One time read. E.g. command is due to virus scan, backup, file copy, or archive.	0111b	Speculative read. The command is part of a prefetch operation.	1000b	The LBA range is going to be overwritten in the near future.	1001b – 1111b	Reserved
	Bits	Attribute	Definition																																													
	07	Incompressible	If set to '1', then data is not compressible for the logical blocks indicated. If cleared to '0', then no information on compression is provided.																																													
	06	Sequential Request	If set to '1', then this command is part of a sequential read that includes multiple Read commands. If cleared to '0', then no information on sequential access is provided.																																													
05:04	Access Latency	<table border="1"> <thead> <tr> <th>Value</th> <th>Definition</th> </tr> </thead> <tbody> <tr> <td>00b</td> <td>None. No latency information provided.</td> </tr> <tr> <td>01b</td> <td>Idle. Longer latency acceptable.</td> </tr> <tr> <td>10b</td> <td>Normal. Typical latency.</td> </tr> <tr> <td>11b</td> <td>Low. Smallest possible latency.</td> </tr> </tbody> </table>	Value	Definition	00b	None. No latency information provided.	01b	Idle. Longer latency acceptable.	10b	Normal. Typical latency.	11b	Low. Smallest possible latency.																																				
		Value	Definition																																													
		00b	None. No latency information provided.																																													
		01b	Idle. Longer latency acceptable.																																													
10b	Normal. Typical latency.																																															
11b	Low. Smallest possible latency.																																															
03:00	Access Frequency	<table border="1"> <thead> <tr> <th>Value</th> <th>Definition</th> </tr> </thead> <tbody> <tr> <td>0000b</td> <td>No frequency information provided.</td> </tr> <tr> <td>0001b</td> <td>Typical number of reads and writes expected for this LBA range.</td> </tr> <tr> <td>0010b</td> <td>Infrequent writes and infrequent reads to the LBA range indicated.</td> </tr> <tr> <td>0011b</td> <td>Infrequent writes and frequent reads to the LBA range indicated.</td> </tr> <tr> <td>0100b</td> <td>Frequent writes and infrequent reads to the LBA range indicated.</td> </tr> <tr> <td>0101b</td> <td>Frequent writes and frequent reads to the LBA range indicated.</td> </tr> <tr> <td>0110b</td> <td>One time read. E.g. command is due to virus scan, backup, file copy, or archive.</td> </tr> <tr> <td>0111b</td> <td>Speculative read. The command is part of a prefetch operation.</td> </tr> <tr> <td>1000b</td> <td>The LBA range is going to be overwritten in the near future.</td> </tr> <tr> <td>1001b – 1111b</td> <td>Reserved</td> </tr> </tbody> </table>	Value	Definition	0000b	No frequency information provided.	0001b	Typical number of reads and writes expected for this LBA range.	0010b	Infrequent writes and infrequent reads to the LBA range indicated.	0011b	Infrequent writes and frequent reads to the LBA range indicated.	0100b	Frequent writes and infrequent reads to the LBA range indicated.	0101b	Frequent writes and frequent reads to the LBA range indicated.	0110b	One time read. E.g. command is due to virus scan, backup, file copy, or archive.	0111b	Speculative read. The command is part of a prefetch operation.	1000b	The LBA range is going to be overwritten in the near future.	1001b – 1111b	Reserved																								
		Value	Definition																																													
		0000b	No frequency information provided.																																													
		0001b	Typical number of reads and writes expected for this LBA range.																																													
		0010b	Infrequent writes and infrequent reads to the LBA range indicated.																																													
		0011b	Infrequent writes and frequent reads to the LBA range indicated.																																													
		0100b	Frequent writes and infrequent reads to the LBA range indicated.																																													
		0101b	Frequent writes and frequent reads to the LBA range indicated.																																													
		0110b	One time read. E.g. command is due to virus scan, backup, file copy, or archive.																																													
		0111b	Speculative read. The command is part of a prefetch operation.																																													
1000b	The LBA range is going to be overwritten in the near future.																																															
1001b – 1111b	Reserved																																															

Figure 142: Read – Command Dword 14

Bit	Description
31:00	<p>Expected Initial Logical Block Reference Tag (EILBRT): This field specifies the Initial Logical Block Reference Tag expected value. This field is only used if the namespace is formatted to use end-to-end protection information. Refer to section 8.3.</p>

Figure 143: Read – Command Dword 15

Bit	Description
31:16	Expected Logical Block Application Tag Mask (ELBATM): This field specifies the Application Tag Mask expected value. This field is only used if the namespace is formatted to use end-to-end protection information. Refer to section 8.3.
15:00	Expected Logical Block Application Tag (ELBAT): This field specifies the Application Tag expected value. This field is only used if the namespace is formatted to use end-to-end protection information. Refer to section 8.3.

6.8.1 Command Completion

When the command is completed with success or failure, the controller shall post a completion queue entry to the associated I/O Completion Queue indicating the status for the command.

Read command specific status values are defined in Figure 144.

Figure 144: Read – Command Specific Status Values

Value	Description
80h	Conflicting Attributes: The attributes specified in the command are conflicting.
81h	Invalid Protection Information: The Protection Information settings specified in the command are invalid.

6.9 Reservation Acquire command

The Reservation Acquire command is used to acquire a reservation on a namespace, preempt a reservation held on a namespace, and abort a reservation held on a namespace.

The command uses Command Dword 10 and a Reservation Acquire data structure in host memory. If the command uses PRPs for the data transfer, then PRP Entry 1 and PRP Entry 2 fields are used. If the command uses SGLs for the data transfer, then the SGL Entry 1 field is used. All other command specific fields are reserved.

Figure 145: Reservation Acquire – PRP Entries or SGL Entry 1

Bit	Description				
127:00	If CDW0[15] is cleared to '0', then the definition of this field is:				
	<table border="1"> <tr> <td>127:64</td> <td>PRP Entry 2 (PRP2): This field contains the second PRP entry that specifies the location where data is transferred from (if there is a physical discontinuity). This field shall not be a pointer to a PRP List.</td> </tr> <tr> <td>63:00</td> <td>PRP Entry 1 (PRP1): Indicates a data buffer where data is transferred from.</td> </tr> </table>	127:64	PRP Entry 2 (PRP2): This field contains the second PRP entry that specifies the location where data is transferred from (if there is a physical discontinuity). This field shall not be a pointer to a PRP List.	63:00	PRP Entry 1 (PRP1): Indicates a data buffer where data is transferred from.
	127:64	PRP Entry 2 (PRP2): This field contains the second PRP entry that specifies the location where data is transferred from (if there is a physical discontinuity). This field shall not be a pointer to a PRP List.			
63:00	PRP Entry 1 (PRP1): Indicates a data buffer where data is transferred from.				
If CDW0[15] is set to '1', then the definition of this field is:					
	<table border="1"> <tr> <td>127:00</td> <td>SGL Entry 1 (SGL1): This field contains the first SGL segment for the command, indicating the location of a data buffer where data is transferred from.</td> </tr> </table>	127:00	SGL Entry 1 (SGL1): This field contains the first SGL segment for the command, indicating the location of a data buffer where data is transferred from.		
127:00	SGL Entry 1 (SGL1): This field contains the first SGL segment for the command, indicating the location of a data buffer where data is transferred from.				

Figure 146: Reservation Acquire – Command Dword 10

Bit	Description										
31:16	Reserved										
15:08	Reservation Type (RTYPE): This field specifies the type of reservation to be created. The field is defined in Figure 148.										
07:04	Reserved										
03	Ignore Existing Key (IEKEY): If this bit is set to a '1', then the Current Reservation Key (CRKEY) check is disabled and the command shall succeed regardless of the CRKEY field value.										
02:00	<p>Reservation Acquire Action (RACQA): This field specifies the action that is performed by the command.</p> <table border="1"> <thead> <tr> <th>RACQA Value</th> <th>Description</th> </tr> </thead> <tbody> <tr> <td>000b</td> <td>Acquire</td> </tr> <tr> <td>001b</td> <td>Preempt</td> </tr> <tr> <td>010b</td> <td>Preempt and Abort</td> </tr> <tr> <td>011b - 111b</td> <td>Reserved</td> </tr> </tbody> </table>	RACQA Value	Description	000b	Acquire	001b	Preempt	010b	Preempt and Abort	011b - 111b	Reserved
RACQA Value	Description										
000b	Acquire										
001b	Preempt										
010b	Preempt and Abort										
011b - 111b	Reserved										

Figure 147: Reservation Acquire Data Structure

Bytes	O/M	Description
7:0	M	Current Reservation Key (CRKEY): The field specifies the current reservation key associated with the host. If the IEKEY bit is set to '1' in the command, then the CRKEY check succeeds regardless of the value in this field.
15:8	M	Preempt Reservation Key (PRKEY): If the Reservation Acquire Action is set to 001b (i.e., Preempt) or 010b (i.e., Preempt and Abort), then this field specifies the reservation key to be unregistered from the namespace. For all other Reservation Acquire Action values, this field is reserved.

Figure 148: Reservation Type Encoding

Value	Description
0h	Reserved
1h	Write Exclusive Reservation
2h	Exclusive Access Reservation
3h	Write Exclusive - Registrants Only Reservation
4h	Exclusive Access - Registrants Only Reservation
5h	Write Exclusive - All Registrants Reservation
6h	Exclusive Access - All Registrants Reservation
07h-FFh	Reserved

6.9.1 Command Completion

When the command is completed, the controller shall post a completion queue entry to the associated I/O Completion Queue indicating the status for the command.

6.10 Reservation Register command

The Reservation Register command is used to register, unregister, or replace a reservation key.

The command uses Command Dword 10 and a Reservation Register data structure in host memory. If the command uses PRPs for the data transfer, then PRP Entry 1 and PRP Entry 2 fields are used. If the command uses SGLs for the data transfer, then the SGL Entry 1 field is used. All other command specific fields are reserved.

Figure 149: Reservation Register – PRP Entries or SGL Entry 1

Bit	Description				
127:00	If CDW0[15] is cleared to '0', then the definition of this field is:				
	<table border="1"> <tr> <td>127:64</td> <td>PRP Entry 2 (PRP2): This field contains the second PRP entry that specifies the location where data is transferred from (if there is a physical discontinuity). This field shall not be a pointer to a PRP List.</td> </tr> <tr> <td>63:00</td> <td>PRP Entry 1 (PRP1): Indicates a data buffer where data is transferred from.</td> </tr> </table>	127:64	PRP Entry 2 (PRP2): This field contains the second PRP entry that specifies the location where data is transferred from (if there is a physical discontinuity). This field shall not be a pointer to a PRP List.	63:00	PRP Entry 1 (PRP1): Indicates a data buffer where data is transferred from.
	127:64	PRP Entry 2 (PRP2): This field contains the second PRP entry that specifies the location where data is transferred from (if there is a physical discontinuity). This field shall not be a pointer to a PRP List.			
63:00	PRP Entry 1 (PRP1): Indicates a data buffer where data is transferred from.				
If CDW0[15] is set to '1', then the definition of this field is:					
127:00	SGL Entry 1 (SGL1): This field contains the first SGL segment for the command, indicating the location of a data buffer where data is transferred from.				

Figure 150: Reservation Register – Command Dword 10

Bit	Description										
31:30	Change Persist Through Power Loss State (CPTPL): This field allows the Persist Through Power Loss state associated with the namespace to be modified as a side effect of processing this command.										
	<table border="1"> <thead> <tr> <th>CPTPL Value</th> <th>Description</th> </tr> </thead> <tbody> <tr> <td>00b</td> <td>No change to PTPL state</td> </tr> <tr> <td>01b</td> <td>Reserved</td> </tr> <tr> <td>10b</td> <td>Set PTPL state to '0'. Reservations are released and registrants are cleared on a power on.</td> </tr> <tr> <td>11b</td> <td>Set PTPL state to '1'. Reservations and registrants persist across a power loss.</td> </tr> </tbody> </table>	CPTPL Value	Description	00b	No change to PTPL state	01b	Reserved	10b	Set PTPL state to '0'. Reservations are released and registrants are cleared on a power on.	11b	Set PTPL state to '1'. Reservations and registrants persist across a power loss.
	CPTPL Value	Description									
	00b	No change to PTPL state									
	01b	Reserved									
10b	Set PTPL state to '0'. Reservations are released and registrants are cleared on a power on.										
11b	Set PTPL state to '1'. Reservations and registrants persist across a power loss.										
29:04	Reserved										
03	Ignore Existing Key (IEKEY): If this bit is set to a '1', then Reservation Register Action (RREGA) field values that use the Current Reservation Key (CRKEY) shall succeed regardless of the value of the Current Reservation Key field in the command (i.e., the current reservation key is not checked).										
02:00	Reservation Register Action (RREGA): This field specifies the registration action that is performed by the command.										
	<table border="1"> <thead> <tr> <th>RREGA Value</th> <th>Description</th> </tr> </thead> <tbody> <tr> <td>000b</td> <td>Register Reservation Key</td> </tr> <tr> <td>001b</td> <td>Unregister Reservation Key</td> </tr> <tr> <td>010b</td> <td>Replace Reservation Key</td> </tr> <tr> <td>011b - 111b</td> <td>Reserved</td> </tr> </tbody> </table>	RREGA Value	Description	000b	Register Reservation Key	001b	Unregister Reservation Key	010b	Replace Reservation Key	011b - 111b	Reserved
	RREGA Value	Description									
	000b	Register Reservation Key									
	001b	Unregister Reservation Key									
010b	Replace Reservation Key										
011b - 111b	Reserved										

Figure 151: Reservation Register Data Structure

Bytes	O/M	Description
7:0	M	Current Reservation Key (CRKEY): If the Reservation Register Action is 001b (i.e., Unregister Reservation Key) or 010b (i.e., Replace Reservation Key), then this field contains the current reservation key associated with the host. For all other Reservation Register Action values, this field is reserved. The controller ignores the value of this field when the Ignore Existing Key (IEKEY) bit is set to '1'.
15:8	M	New Reservation Key (NRKEY): If the Reservation Register Action is 000b (i.e., Register Reservation Key) or 010b (i.e., Replace Reservation Key), then this field contains the new reservation key associated with the host. For all other Reservation Register Action values, this field is reserved.

6.10.1 Command Completion

When the command is completed, the controller shall post a completion queue entry to the associated I/O Completion Queue indicating the status for the command.

6.11 Reservation Release command

The Reservation Release command is used to release or clear a reservation held on a namespace.

The command uses Command Dword 10 and a Reservation Release data structure in host memory. If the command uses PRPs for the data transfer, then PRP Entry 1 and PRP Entry 2 fields are used. If the command uses SGLs for the data transfer, then the SGL Entry 1 field is used. All other command specific fields are reserved.

Figure 152: Reservation Release – PRP Entries or SGL Entry 1

Bit	Description				
127:00	If CDW0[15] is cleared to '0', then the definition of this field is:				
	<table border="1"> <tr> <td>127:64</td> <td>PRP Entry 2 (PRP2): This field contains the second PRP entry that specifies the location where data is transferred from (if there is a physical discontinuity). This field shall not be a pointer to a PRP List.</td> </tr> <tr> <td>63:00</td> <td>PRP Entry 1 (PRP1): Indicates a data buffer where data is transferred from.</td> </tr> </table>	127:64	PRP Entry 2 (PRP2): This field contains the second PRP entry that specifies the location where data is transferred from (if there is a physical discontinuity). This field shall not be a pointer to a PRP List.	63:00	PRP Entry 1 (PRP1): Indicates a data buffer where data is transferred from.
	127:64	PRP Entry 2 (PRP2): This field contains the second PRP entry that specifies the location where data is transferred from (if there is a physical discontinuity). This field shall not be a pointer to a PRP List.			
63:00	PRP Entry 1 (PRP1): Indicates a data buffer where data is transferred from.				
If CDW0[15] is set to '1', then the definition of this field is:					
	<table border="1"> <tr> <td>127:00</td> <td>SGL Entry 1 (SGL1): This field contains the first SGL segment for the command, indicating the location of a data buffer where data is transferred from.</td> </tr> </table>	127:00	SGL Entry 1 (SGL1): This field contains the first SGL segment for the command, indicating the location of a data buffer where data is transferred from.		
127:00	SGL Entry 1 (SGL1): This field contains the first SGL segment for the command, indicating the location of a data buffer where data is transferred from.				

Figure 153: Reservation Release – Command Dword 10

Bit	Description		
31:16	Reserved		
15:08	Reservation Type (RTYPE): If the Reservation Release Action is 00b (i.e., Release), then this field specifies the type of reservation that is being released. The reservation type in this field shall match the current reservation type. This field is defined in Figure 148.		
07:04	Reserved		
03	Ignore Existing Key (IEKEY): If this bit is set to a '1', then the Current Reservation Key (CRKEY) check is disabled and the command succeeds regardless of the CRKEY field value.		
02:00	Reservation Release Action (RRELA): This field specifies the registration action that is performed by the command.		
		RRELA Value	Description
		000b	Release
		001b	Clear
	001b - 111b	Reserved	

Figure 154: Reservation Release Data Structure

Bytes	O/M	Description
7:0	M	Current Reservation Key (CRKEY): The field specifies the current reservation key associated with the host. If the IEKEY bit is set to '1' in the command, then the CRKEY check succeeds regardless of the value in this field.

6.11.1 Command Completion

When the command is completed, the controller shall post a completion queue entry to the associated I/O Completion Queue indicating the status for the command.

6.12 Reservation Report command

The Reservation Report command returns a Reservation Status data structure to host memory that describes the registration and reservation status of a namespace.

The size of the Reservation Status data structure is a function of the number of controllers in the NVM Subsystem that are associated with hosts that are registrants of the namespace (i.e., there is a Registered Controller data structure for each such controller).

The command uses Command Dword 10. If the command uses PRPs for the data transfer, then PRP Entry 1 and PRP Entry 2 fields are used. If the command uses SGLs for the data transfer, then the SGL Entry 1 field is used. All other command specific fields are reserved.

Figure 155: Reservation Release – PRP Entries or SGL Entry 1

Bit	Description				
127:00	If CDW0[15] is cleared to '0', then the definition of this field is:				
	<table border="1"> <tr> <td>127:64</td> <td>PRP Entry 2 (PRP2): This field contains the second PRP entry. If the number of Dwords of the Reservation Status data structure that are to be transferred is satisfied with PRP Entry 1, then this field is reserved. If it is satisfied with two PRP entries total, then this entry specifies the location where data is transferred to. If it requires more than two PRP entries, then this field contains a pointer to a PRP List.</td> </tr> <tr> <td>63:00</td> <td>PRP Entry 1 (PRP1): Indicates a data buffer where data is transferred to.</td> </tr> </table>	127:64	PRP Entry 2 (PRP2): This field contains the second PRP entry. If the number of Dwords of the Reservation Status data structure that are to be transferred is satisfied with PRP Entry 1, then this field is reserved. If it is satisfied with two PRP entries total, then this entry specifies the location where data is transferred to. If it requires more than two PRP entries, then this field contains a pointer to a PRP List.	63:00	PRP Entry 1 (PRP1): Indicates a data buffer where data is transferred to.
	127:64	PRP Entry 2 (PRP2): This field contains the second PRP entry. If the number of Dwords of the Reservation Status data structure that are to be transferred is satisfied with PRP Entry 1, then this field is reserved. If it is satisfied with two PRP entries total, then this entry specifies the location where data is transferred to. If it requires more than two PRP entries, then this field contains a pointer to a PRP List.			
	63:00	PRP Entry 1 (PRP1): Indicates a data buffer where data is transferred to.			
	If CDW0[15] is set to '1', then the definition of this field is:				
127:00	SGL Entry 1 (SGL1): This field contains the first SGL segment for the command, indicating the location of a data buffer where data is transferred to.				

Figure 156: Reservation Report – Command Dword 10

Bit	Description
31:00	Number of Dwords (NUMD): This field specifies the number of Dwords of the Reservation Status data structure to transfer. This is a 0's based value. If this field corresponds to a length that is less than the size of the Reservation Status data structure, then only that specified portion of the data structure is transferred. If this field corresponds to a length that is greater than the size of the Reservation Status data structure, then the entire contents of the data structure are transferred and no additional data is transferred.

Figure 157: Reservation Status Data Structure

Bytes	Description						
3:0	<p>Generation (GEN): This field contains a 32-bit wrapping counter that is incremented any time any one the following occur:</p> <ul style="list-style-type: none"> • A Reservation Register command completes successfully on any controller associated with the namespace, • a Reservation Release command with Reservation Release Action (RRELA) set to 001b (i.e., Clear) completes successfully on any controller associated with the namespace, and • a Reservation Acquire command with Reservation Acquire Action (RACQA) set to 001b (Preempt) or 010b (Preempt and Abort) completes successfully on any controller associated with the namespace. 						
4	<p>Reservation Type (RTYPE): This field indicates whether a reservation is held on the namespace. A value of zero indicates that no reservation is held on the namespace. A non-zero value indicates a reservation is held on the namespace and the reservation type is defined in Figure 148.</p>						
6:5	<p>Number of Registered Controllers (REGCTL): This field indicates the number of controllers that are associated with hosts that are registrants of the namespace. This indicates the number of Registered Controller data structures contained in this data structure.</p>						
8:7	Reserved						
9	<p>Persist Through Power Loss State (PTPLS): This field indicates the Persist Through Power Loss State associated with the namespace.</p> <table border="1" style="margin-left: 40px;"> <thead> <tr> <th>PTPLS Value</th> <th>Description</th> </tr> </thead> <tbody> <tr> <td>0</td> <td>Reservations are released and registrants are cleared on a power on.</td> </tr> <tr> <td>1</td> <td>Reservations and registrants persist across a power loss.</td> </tr> </tbody> </table>	PTPLS Value	Description	0	Reservations are released and registrants are cleared on a power on.	1	Reservations and registrants persist across a power loss.
PTPLS Value	Description						
0	Reservations are released and registrants are cleared on a power on.						
1	Reservations and registrants persist across a power loss.						
23:10	Reserved						
47:24	Registered Controller DataStructure 0						
	⋮						
	⋮						
n:(n-24)	Registered Controller DataStructure (n/24 -1)						

Figure 158: Registered Controller Data Structure

Bytes	Description
1:0	<p>Controller ID (CNTLID): This field contains the controller ID (i.e., the value of the CNTLID field in the Identify Controller data structure) of the controller whose status is reported in this data structure.</p>
2	<p>Reservation Status (RCSTS): This field indicates the reservation status of the controller described by this data structure.</p> <p>Bits 7:1 are reserved</p> <p>Bit 0 is set to '1' if the controller is associated with a host that holds a reservation on the namespace.</p>
7:3	Reserved
15:8	<p>Host Identifier (HOSTID): This field contains the Host Identifier of the controller described by this data structure.</p>
23:16	<p>Reservation Key (RKEY): This field contains the reservation key of the host associated with the controller described by this data structure.</p>

6.12.1 Command Completion

When the command is completed, the controller shall post a completion queue entry to the associated I/O Completion Queue indicating the status for the command.

6.13 Write command

The Write command writes data and metadata, if applicable, to the NVM controller for the logical blocks indicated. The host may also specify protection information to include as part of the operation.

The command uses Command Dword 10, Command Dword 11, Command Dword 12, Command Dword 13, Command Dword 14, and Command Dword 15 fields. If the command uses PRPs for the data transfer, then the Metadata Pointer, PRP Entry 1, and PRP Entry 2 fields are used. If the command uses SGLs for the data transfer, then the Metadata SGL Segment Pointer and SGL Entry 1 fields are used.

Figure 159: Write – Metadata (SGL Segment) Pointer

Bit	Description		
63:00	If CDW0[15] is cleared to '0', then the definition of this field is:		
	<table border="1"> <tr> <td>63:00</td> <td>Metadata Pointer (MPTR): This field contains the address of a contiguous physical buffer of metadata. This field shall be Dword aligned.</td> </tr> </table>	63:00	Metadata Pointer (MPTR): This field contains the address of a contiguous physical buffer of metadata. This field shall be Dword aligned.
	63:00	Metadata Pointer (MPTR): This field contains the address of a contiguous physical buffer of metadata. This field shall be Dword aligned.	
If CDW0[15] is set to '1', then the definition of this field is:			
	<table border="1"> <tr> <td>63:00</td> <td>Metadata SGL Segment Pointer (MSGLP): This field contains the address of an SGL segment that describes the metadata to transfer.</td> </tr> </table>	63:00	Metadata SGL Segment Pointer (MSGLP): This field contains the address of an SGL segment that describes the metadata to transfer.
63:00	Metadata SGL Segment Pointer (MSGLP): This field contains the address of an SGL segment that describes the metadata to transfer.		

Figure 160: Write – PRP Entries of SGL Entry 1

Bit	Description				
127:00	If CDW0[15] is cleared to '0', then the definition of this field is:				
	<table border="1"> <tr> <td>127:64</td> <td>PRP Entry 2 (PRP2): This field contains the second PRP entry. If the data transfer is satisfied with PRP Entry 1, then this field is reserved. If the data transfer may be satisfied with two PRP entries total, then this entry specifies the location where data should be transferred from. If the data transfer requires more than two PRP entries, then this field includes a pointer to a PRP List.</td> </tr> <tr> <td>63:00</td> <td>PRP Entry 1 (PRP1): This field contains the first PRP entry, indicating the location of data that should be transferred from.</td> </tr> </table>	127:64	PRP Entry 2 (PRP2): This field contains the second PRP entry. If the data transfer is satisfied with PRP Entry 1, then this field is reserved. If the data transfer may be satisfied with two PRP entries total, then this entry specifies the location where data should be transferred from. If the data transfer requires more than two PRP entries, then this field includes a pointer to a PRP List.	63:00	PRP Entry 1 (PRP1): This field contains the first PRP entry, indicating the location of data that should be transferred from.
	127:64	PRP Entry 2 (PRP2): This field contains the second PRP entry. If the data transfer is satisfied with PRP Entry 1, then this field is reserved. If the data transfer may be satisfied with two PRP entries total, then this entry specifies the location where data should be transferred from. If the data transfer requires more than two PRP entries, then this field includes a pointer to a PRP List.			
	63:00	PRP Entry 1 (PRP1): This field contains the first PRP entry, indicating the location of data that should be transferred from.			
If CDW0[15] is set to '1', then the definition of this field is:					
<table border="1"> <tr> <td>127:00</td> <td>SGL Entry 1 (SGL1): This field contains the first SGL segment for the command, indicating the location of data that should be transferred from.</td> </tr> </table>	127:00	SGL Entry 1 (SGL1): This field contains the first SGL segment for the command, indicating the location of data that should be transferred from.			
127:00	SGL Entry 1 (SGL1): This field contains the first SGL segment for the command, indicating the location of data that should be transferred from.				

Figure 161: Write – Command Dword 10 and Command Dword 11

Bit	Description
63:00	Starting LBA (SLBA): This field indicates the 64-bit address of the first logical block to be written as part of the operation. Command Dword 10 contains bits 31:00; Command Dword 11 contains bits 63:32.

Figure 162: Write – Command Dword 12

Bit	Description
31	Limited Retry (LR): If set to '1', the controller should apply limited retry efforts. If cleared to '0', the controller should apply all available error recovery means to write the data to the NVM.
30	Force Unit Access (FUA): This field indicates that the data shall be written to non-volatile media before indicating command completion. There is no implied ordering with other commands.
29:26	Protection Information Field (PRINFO): Specifies the protection information action and check field, as defined in Figure 123.
25:16	Reserved
15:00	Number of Logical Blocks (NLB): This field indicates the number of logical blocks to be written. This is a 0's based value.

Figure 163: Write – Command Dword 13

Bit	Description																																											
31:08	Reserved																																											
07:00	<p>Dataset Management (DSM): This field indicates attributes for the dataset that the LBA(s) being read are associated with.</p> <table border="1"> <thead> <tr> <th>Bits</th> <th>Attribute</th> <th>Definition</th> </tr> </thead> <tbody> <tr> <td>07</td> <td>Incompressible</td> <td>If set to '1', then data is not compressible for the logical blocks indicated. If cleared to '0', then no information on compression is provided.</td> </tr> <tr> <td>06</td> <td>Sequential Request</td> <td>If set to '1', then this command is part of a sequential write that includes multiple Write commands. If cleared to '0', then no information on sequential access is provided.</td> </tr> <tr> <td>05:04</td> <td>Access Latency</td> <td> <table border="1"> <thead> <tr> <th>Value</th> <th>Definition</th> </tr> </thead> <tbody> <tr> <td>00b</td> <td>None. No latency information provided.</td> </tr> <tr> <td>01b</td> <td>Idle. Longer latency acceptable.</td> </tr> <tr> <td>10b</td> <td>Normal. Typical latency.</td> </tr> <tr> <td>11b</td> <td>Low. Smallest possible latency.</td> </tr> </tbody> </table> </td> </tr> <tr> <td>03:00</td> <td>Access Frequency</td> <td> <table border="1"> <thead> <tr> <th>Value</th> <th>Definition</th> </tr> </thead> <tbody> <tr> <td>0000b</td> <td>No frequency information provided.</td> </tr> <tr> <td>0001b</td> <td>Typical number of reads and writes expected for this LBA range.</td> </tr> <tr> <td>0010b</td> <td>Infrequent writes and infrequent reads to the LBA range indicated.</td> </tr> <tr> <td>0011b</td> <td>Infrequent writes and frequent reads to the LBA range indicated.</td> </tr> <tr> <td>0100b</td> <td>Frequent writes and infrequent reads to the LBA range indicated.</td> </tr> <tr> <td>0101b</td> <td>Frequent writes and frequent reads to the LBA range indicated.</td> </tr> <tr> <td>0110b</td> <td>One time write. E.g. command is due to virus scan, backup, file copy, or archive.</td> </tr> <tr> <td>0111b – 1111b</td> <td>Reserved</td> </tr> </tbody> </table> </td> </tr> </tbody> </table>	Bits	Attribute	Definition	07	Incompressible	If set to '1', then data is not compressible for the logical blocks indicated. If cleared to '0', then no information on compression is provided.	06	Sequential Request	If set to '1', then this command is part of a sequential write that includes multiple Write commands. If cleared to '0', then no information on sequential access is provided.	05:04	Access Latency	<table border="1"> <thead> <tr> <th>Value</th> <th>Definition</th> </tr> </thead> <tbody> <tr> <td>00b</td> <td>None. No latency information provided.</td> </tr> <tr> <td>01b</td> <td>Idle. Longer latency acceptable.</td> </tr> <tr> <td>10b</td> <td>Normal. Typical latency.</td> </tr> <tr> <td>11b</td> <td>Low. Smallest possible latency.</td> </tr> </tbody> </table>	Value	Definition	00b	None. No latency information provided.	01b	Idle. Longer latency acceptable.	10b	Normal. Typical latency.	11b	Low. Smallest possible latency.	03:00	Access Frequency	<table border="1"> <thead> <tr> <th>Value</th> <th>Definition</th> </tr> </thead> <tbody> <tr> <td>0000b</td> <td>No frequency information provided.</td> </tr> <tr> <td>0001b</td> <td>Typical number of reads and writes expected for this LBA range.</td> </tr> <tr> <td>0010b</td> <td>Infrequent writes and infrequent reads to the LBA range indicated.</td> </tr> <tr> <td>0011b</td> <td>Infrequent writes and frequent reads to the LBA range indicated.</td> </tr> <tr> <td>0100b</td> <td>Frequent writes and infrequent reads to the LBA range indicated.</td> </tr> <tr> <td>0101b</td> <td>Frequent writes and frequent reads to the LBA range indicated.</td> </tr> <tr> <td>0110b</td> <td>One time write. E.g. command is due to virus scan, backup, file copy, or archive.</td> </tr> <tr> <td>0111b – 1111b</td> <td>Reserved</td> </tr> </tbody> </table>	Value	Definition	0000b	No frequency information provided.	0001b	Typical number of reads and writes expected for this LBA range.	0010b	Infrequent writes and infrequent reads to the LBA range indicated.	0011b	Infrequent writes and frequent reads to the LBA range indicated.	0100b	Frequent writes and infrequent reads to the LBA range indicated.	0101b	Frequent writes and frequent reads to the LBA range indicated.	0110b	One time write. E.g. command is due to virus scan, backup, file copy, or archive.	0111b – 1111b	Reserved
	Bits	Attribute	Definition																																									
	07	Incompressible	If set to '1', then data is not compressible for the logical blocks indicated. If cleared to '0', then no information on compression is provided.																																									
	06	Sequential Request	If set to '1', then this command is part of a sequential write that includes multiple Write commands. If cleared to '0', then no information on sequential access is provided.																																									
05:04	Access Latency	<table border="1"> <thead> <tr> <th>Value</th> <th>Definition</th> </tr> </thead> <tbody> <tr> <td>00b</td> <td>None. No latency information provided.</td> </tr> <tr> <td>01b</td> <td>Idle. Longer latency acceptable.</td> </tr> <tr> <td>10b</td> <td>Normal. Typical latency.</td> </tr> <tr> <td>11b</td> <td>Low. Smallest possible latency.</td> </tr> </tbody> </table>	Value	Definition	00b	None. No latency information provided.	01b	Idle. Longer latency acceptable.	10b	Normal. Typical latency.	11b	Low. Smallest possible latency.																																
Value	Definition																																											
00b	None. No latency information provided.																																											
01b	Idle. Longer latency acceptable.																																											
10b	Normal. Typical latency.																																											
11b	Low. Smallest possible latency.																																											
03:00	Access Frequency	<table border="1"> <thead> <tr> <th>Value</th> <th>Definition</th> </tr> </thead> <tbody> <tr> <td>0000b</td> <td>No frequency information provided.</td> </tr> <tr> <td>0001b</td> <td>Typical number of reads and writes expected for this LBA range.</td> </tr> <tr> <td>0010b</td> <td>Infrequent writes and infrequent reads to the LBA range indicated.</td> </tr> <tr> <td>0011b</td> <td>Infrequent writes and frequent reads to the LBA range indicated.</td> </tr> <tr> <td>0100b</td> <td>Frequent writes and infrequent reads to the LBA range indicated.</td> </tr> <tr> <td>0101b</td> <td>Frequent writes and frequent reads to the LBA range indicated.</td> </tr> <tr> <td>0110b</td> <td>One time write. E.g. command is due to virus scan, backup, file copy, or archive.</td> </tr> <tr> <td>0111b – 1111b</td> <td>Reserved</td> </tr> </tbody> </table>	Value	Definition	0000b	No frequency information provided.	0001b	Typical number of reads and writes expected for this LBA range.	0010b	Infrequent writes and infrequent reads to the LBA range indicated.	0011b	Infrequent writes and frequent reads to the LBA range indicated.	0100b	Frequent writes and infrequent reads to the LBA range indicated.	0101b	Frequent writes and frequent reads to the LBA range indicated.	0110b	One time write. E.g. command is due to virus scan, backup, file copy, or archive.	0111b – 1111b	Reserved																								
Value	Definition																																											
0000b	No frequency information provided.																																											
0001b	Typical number of reads and writes expected for this LBA range.																																											
0010b	Infrequent writes and infrequent reads to the LBA range indicated.																																											
0011b	Infrequent writes and frequent reads to the LBA range indicated.																																											
0100b	Frequent writes and infrequent reads to the LBA range indicated.																																											
0101b	Frequent writes and frequent reads to the LBA range indicated.																																											
0110b	One time write. E.g. command is due to virus scan, backup, file copy, or archive.																																											
0111b – 1111b	Reserved																																											

Figure 164: Write – Command Dword 14

Bit	Description
31:00	Initial Logical Block Reference Tag (ILBRT): This field specifies the Initial Logical Block Reference Tag value. This field is only used if the namespace is formatted to use end-to-end protection information. Refer to section 8.3.

Figure 165: Write – Command Dword 15

Bit	Description
31:16	Logical Block Application Tag Mask (LBATM): This field specifies the Application Tag Mask value. This field is only used if the namespace is formatted to use end-to-end protection information. Refer to section 8.3.
15:00	Logical Block Application Tag (LBAT): This field specifies the Application Tag value. This field is only used if the namespace is formatted to use end-to-end protection information. Refer to section 8.3.

6.13.1 Command Completion

When the command is completed with success or failure, the controller shall post a completion queue entry to the associated I/O Completion Queue indicating the status for the command.

Write command specific errors are defined in Figure 166.

Figure 166: Write – Command Specific Errors Values

Value	Description
80h	Conflicting Attributes: The attributes specified in the command are conflicting.
81h	Invalid Protection Information: The Protection Information settings specified in the command are invalid.

6.14 Write Uncorrectable command

The Write Uncorrectable command is used to mark a logical block as invalid. When the specified logical block(s) are read after this operation, a failure is returned with Unrecovered Read Error status. To clear the invalid logical block status, a write operation is performed on those logical blocks.

The fields used are Command Dword 10, Command Dword 11, and Command Dword 12 fields. All other command specific fields are reserved.

Figure 167: Write Uncorrectable – Command Dword 10 and Command Dword 11

Bit	Description
63:00	Starting LBA (SLBA): This field specifies the 64-bit address of the first logical block to be marked as invalid as part of the operation. Command Dword 10 contains bits 31:00; Command Dword 11 contains bits 63: 32.

Figure 168: Write Uncorrectable – Command Dword 12

Bit	Description
31:16	Reserved
15:00	Number of Logical Blocks (NLB): This field specifies the number of logical blocks to be marked as invalid. This is a 0's based value.

6.14.1 Command Completion

If the command is completed, then the controller shall post a completion queue entry to the associated I/O Completion Queue indicating the status for the command.

6.15 Write Zeroes command

The Write Zeroes command is used to set a range of logical blocks to zero. After successful completion of this command, the value returned by subsequent reads of logical blocks in this range shall be zeroes until a write occurs to this LBA range.

The fields used are Command Dword 10, Command Dword 11, Command Dword 12, Command Dword 14, and Command Dword 15 fields.

Figure 169: Write Zeroes – Command Dword 10 and Command Dword 11

Bit	Description
63:00	Starting LBA (SLBA): This field indicates the 64-bit address of the first logical block to be written as part of the operation. Command Dword 10 contains bits 31:00; Command Dword 11 contains bits 63:32.

Figure 170: Write Zeroes – Command Dword 12

Bit	Description
31	Limited Retry (LR): If set to '1', the controller should apply limited retry efforts. If cleared to '0', the controller should apply all available error recovery means to write the data to the NVM.
30	Force Unit Access (FUA): This field indicates that the data shall be written to non-volatile media before indicating command completion. There is no implied ordering with other commands.
29:26	Protection Information Field (PRINFO): Specifies the protection information action and check field, as defined in Figure 123.
25:16	Reserved
15:00	Number of Logical Blocks (NLB): This field indicates the number of logical blocks to be written. This is a 0's based value.

Figure 171: Write Zeroes – Command Dword 14

Bit	Description
31:00	Initial Logical Block Reference Tag (ILBRT): This field indicates the Initial Logical Block Reference Tag value. This field is only used if the namespace is formatted to use end-to-end protection information. Refer to section 8.3.

Figure 172: Write Zeroes – Command Dword 15

Bit	Description
31:16	Logical Block Application Tag Mask (LBATM): This field indicates the Application Tag Mask value. This field is only used if the namespace is formatted to use end-to-end protection information. Refer to section 8.3.
15:00	Logical Block Application Tag (LBAT): This field indicates the Application Tag value. This field is only used if the namespace is formatted to use end-to-end protection information. Refer to section 8.3.

6.15.1 Command Completion

When the command is completed with success or failure, the controller shall post a completion queue entry to the associated I/O Completion Queue indicating the status for the command.

Write Zeroes command specific status values are defined in Figure 173.

Figure 173: Write Zeroes – Command Specific Status Values

Value	Description
81h	Invalid Protection Information: The Protection Information settings specified in the command are invalid.

7 Controller Architecture

7.1 Introduction

Host software submits commands to the controller through pre-allocated Submission Queues. The controller is alerted to newly submitted commands through SQ Tail Doorbell register writes. The difference between the previous doorbell register value and the current register write indicates the number of commands that were submitted.

The controller fetches the commands from the Submission Queue(s) and transmits them to the NVM subsystem for processing. Except for fused operations, there are no ordering restrictions for processing of the commands within or across Submission Queues. Host software should not place commands in the list that may not be re-ordered arbitrarily. Data may or may not be committed to the NVM media in the order that commands are received.

Host software submits commands of higher priorities to the appropriate Submission Queues. Priority is associated with the Submission Queue itself, thus the priority of the command is based on the Submission Queue it is issued through. The controller arbitrates across the Submission Queues based on fairness and priority according to the arbitration scheme specified in section 4.8.

Upon completion of the commands by the NVM subsystem, the controller presents completion queue entries to the host through the appropriate Completion Queues. If MSI-X or multiple message MSI is in use, then the interrupt vector indicates the Completion Queue(s) with possible new command completions for the host to process. If pin-based interrupts or single message MSI interrupts are used, host software interrogates the Completion Queue(s) for new completion queue entries. The host updates the CQ Head doorbell register to release Completion Queue entries to the controller and clear the associated interrupt.

There are no ordering restrictions for completions to the host. Each completion queue entry identifies the Submission Queue Identifier and Command Identifier of the associated command. Host software uses this information to correlate the completions with the commands submitted to the Submission Queue(s).

Host software is responsible for creating all required Submission and Completion Queues prior to submitting commands to the controller. I/O Submission and Completion Queues are created using Admin commands defined in section 5.

7.2 Command Submission and Completion Mechanism (Informative)

This section describes the command issue and completion mechanism. It also describes how commands are built by host software and command completion processing.

7.2.1 Command Processing

This section describes command submission and completion processing. Figure 174 shows the steps that are followed to issue and complete a command. The steps are:

1. The host creates a command for execution within the appropriate Submission Queue in host memory.
2. The host updates the Submission Queue Tail Doorbell register with the new value of the Submission Queue Tail entry pointer. This indicates to the controller that a new command(s) is submitted for processing.
3. The controller fetches the command(s) in the Submission Queue from host memory for future execution.
4. The controller performs command arbitration. The controller may execute commands out of order. The command arbitration mechanism selects the next command to execute from commands that have been previously fetched. The controller then proceeds with execution of the command.

5. After the command has completed execution, the controller writes a completion queue entry to the associated Completion Queue. As part of the completion queue entry, the controller indicates the most recent SQ entry that has been fetched.
6. The controller optionally generates an interrupt to the host to indicate that there is a completion queue entry to process. In the figure, this is shown as an MSI-X interrupt, however, it could also be a pin-based or MSI interrupt. Note that based on interrupt coalescing settings, an interrupt may or may not be indicated for the command.
7. The host processes the completion queue entry in the Completion Queue. This includes taking any actions based on error conditions indicated.
8. The host writes the Completion Queue Head Doorbell register to indicate that the completion queue entry has been processed. The host may process many entries before updating the associated CQHDBL register.

Figure 174: Command Processing

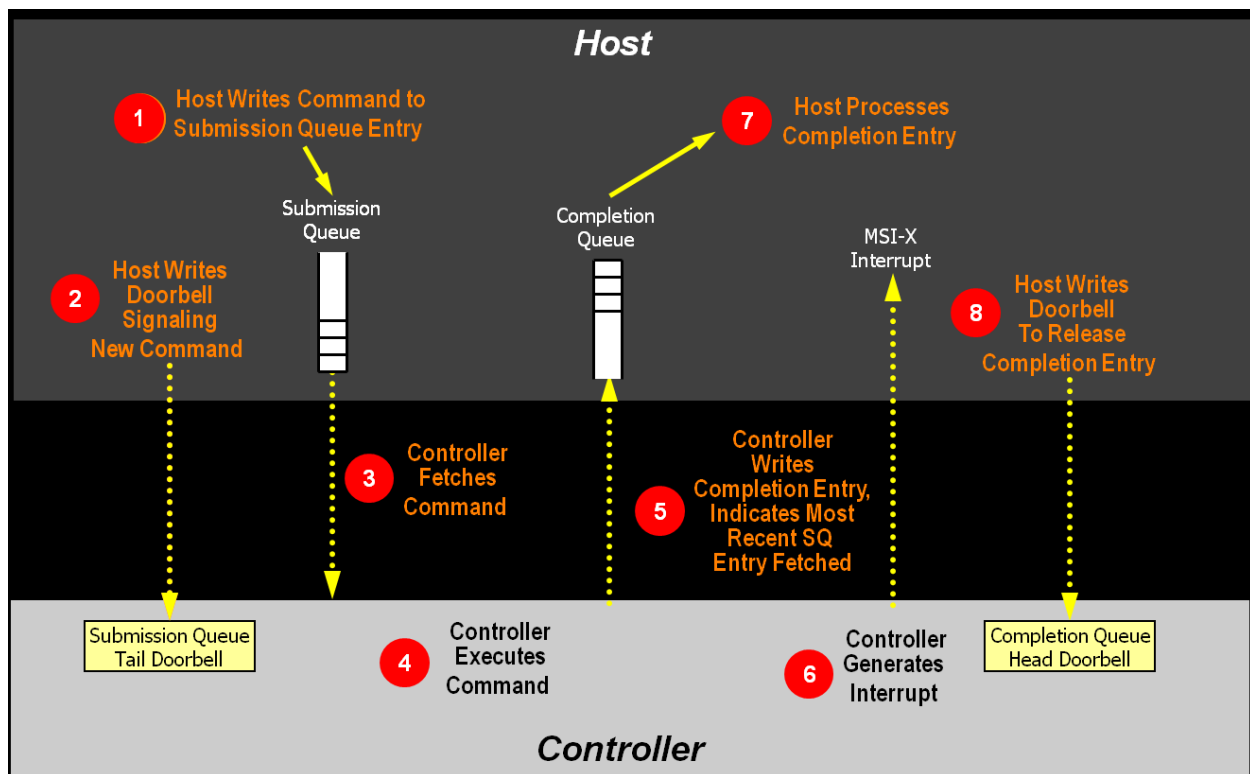

7.2.2 Basic Steps when Building a Command

When host software builds a command for the controller to execute, it first checks to make sure that the appropriate Submission Queue (SQx) is not full. The Submission Queue is full when the number of entries in the queue is one less than the queue size. Once an empty slot (pFreeSlot) is available:

1. Host software builds a command at SQx[pFreeSlot] with:
 - a. CDW0.OPC is set to the appropriate command to be executed by the controller.
 - b. CDW0.FUSE is set to the appropriate value, depending on whether the command is a fused operation.
 - c. CDW0.CID is set to a unique identifier for the command when combined with the Submission Queue identifier.
 - d. The Namespace Identifier, CDW1.NSID, is set to the namespace the command applies to.

- e. MPTR shall be filled in with the offset to the beginning of the Metadata Region, if there is a data transfer and the namespace format contains metadata as a separate buffer.
 - f. PRP1 and/or PRP2 (or SGL Entry 1 if SGLs are used) are set to the source/destination of data transfer, if there is a data transfer.
 - g. CDW10 – CDW15 are set to any command specific information.
2. Host software shall write the corresponding Submission Queue doorbell register (SQxTDBL) to submit one or more commands for processing.

The write to the Submission Queue doorbell register triggers the controller to fetch and process the command contained in the Submission Queue entry. The controller indicates the most recent SQ entry that has been fetched as part of reporting completions. Host software may use this information to determine when SQ locations may be re-used for new commands.

7.2.3 Processing Completed Commands

Host software processes the interrupt generated by the controller for command completion(s). If MSI-X or multiple message MSI is in use, then the interrupt vector implies the Completion Queue(s) with new command completions for the host to process. If pin-based interrupts or single message MSI interrupts are used, then host software interrogates the Completion Queue(s) to determine if new completion queue entries are present for the host to process.

Once the host software determines the Completion Queue (CQy) that generated the interrupt:

1. Host software reads a completion queue entry from the specified Completion Queue.
2. Host software processes the CQ entry to identify the Submission Queue entry that generated this completion. DW2.SQID indicates the Submission Queue ID and DW3.CID indicates the command that generated the completion.
3. DW3.SF indicates the status of the completion.
4. Host software indicates available Completion Queue slots by updating the corresponding Completion Queue Head doorbell register (CQyHDBL). By updating CQyHDBL, the associated interrupt is cleared.
5. If there were errors, noted in the DW3.SF field, host software performs error recovery actions (refer to section 9.1).

7.2.4 Command Related Resource Retirement

As part of reporting completions, the controller indicates the most recent Submission Queue entry that has been fetched. Any Submission Queue entries that are indicated as being fetched may be re-used by host software.

If a completion queue entry is posted for a command, then host software may re-use the associated PRP List(s) for that command and other resources (an exception is the PRP List for I/O Submission Queues and I/O Completion Queues).

7.2.5 Command Examples

7.2.5.1 Creating an I/O Submission Queue

This example describes how host software creates an I/O Submission Queue that utilizes non-contiguous PRP entries. Creating an I/O Submission Queue that utilizes a PRP List is only valid if the controller supports non-contiguous queues as indicated in CAP.CQR.

Prior to creating an I/O Submission Queue, host software shall create the I/O Completion Queue that the SQ uses with the Create I/O Completion Queue command.

To create an I/O Submission Queue, host software builds a Create I/O Submission Queue command for the Admin Submission Queue. Host software builds the Create I/O Submission Queue command in the next free Admin Submission Queue command location. The attributes of the command are:

- CDW0.OPC is set to 01h.
- CDW0.FUSE is set to 00b indicating that this is not a fused operation.
- CDW0.CID is set to a free command identifier.
- CDW1.NSID is set to 0h; Submission Queues are not specific to a namespace.
- MPTR is cleared to 0h; metadata is not used for this command.
- PRP1 is set to the physical address of the PRP List. The PRP List is shown in Figure 175 for a PRP List with three entries.
- PRP2 is cleared to 0h; PRP Entry 2 is not used for this command.
- CDW10.QSIZE is set to the size of queue to create. In this case, it is set to a value of 191, indicating a queue size of 192 entries. The queue size shall not exceed the maximum queue entries supported, indicated in the CAP.MQES field.
- CDW10.QID is set to the Submission Queue identifier.
- CDW11.CQID is set to the I/O Completion Queue identifier where command completions are posted.
- CDW11.QPRIO is set to 10b, indicating a Medium priority queue.
- CDW11.PC is cleared to '0' indicating that the data buffer indicated by PRP1 is not physically contiguously.

After the command is built, host software submits the command for execution by writing the Admin Submission Queue doorbell (SQ0TDBL) to indicate to the controller that this command is available for processing.

Host software shall maintain the PRP List unmodified in host memory until the Submission Queue is deleted.

Figure 175: PRP List Describing I/O Submission Queue

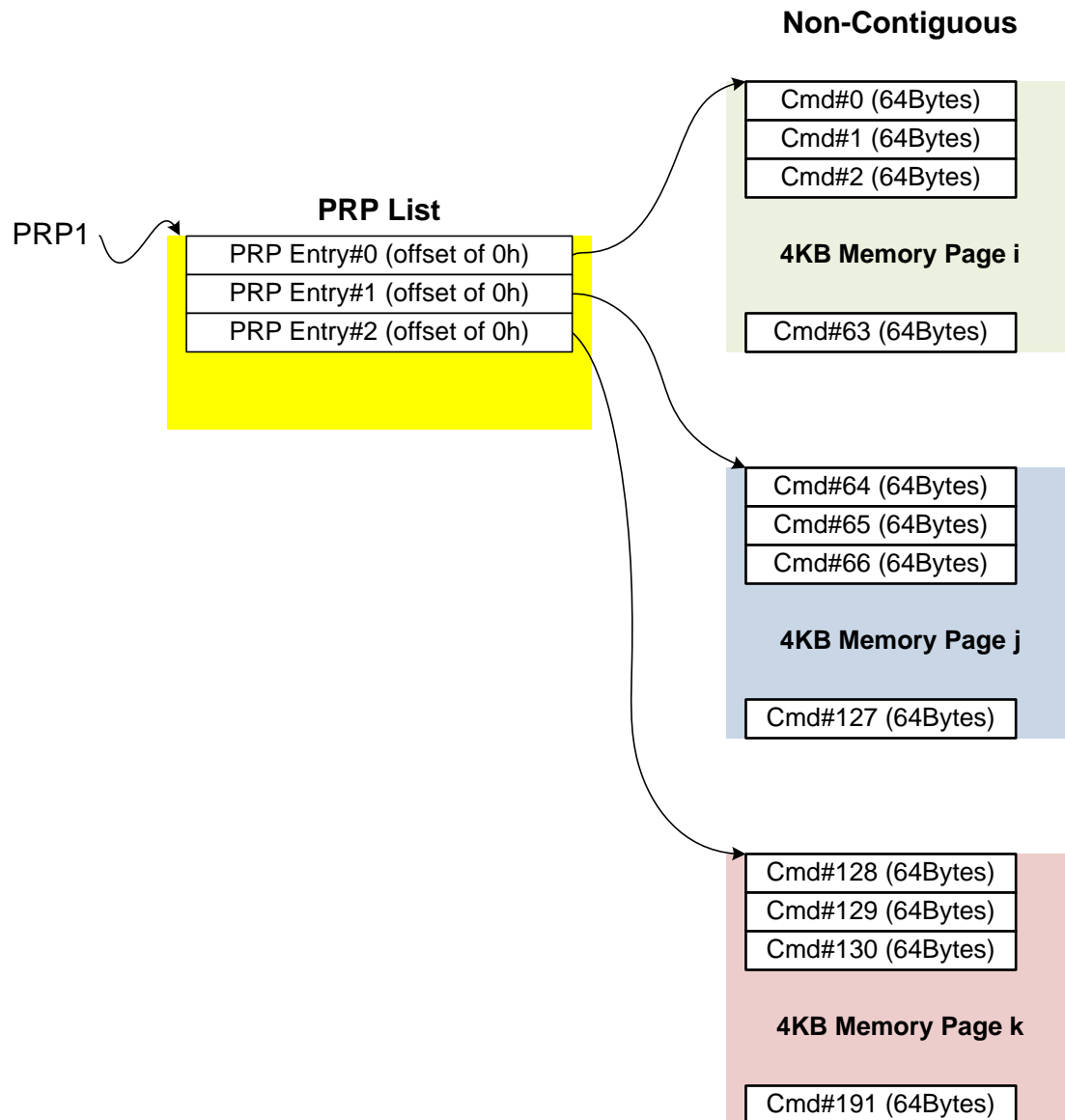

7.2.5.2 Executing a Fused Operation

This example describes how host software creates and executes a fused command, specifically Compare and Write for a total of 16KB of data. In this case, there are two commands that are created. The first command is the Compare, referred to as CMD0. The second command is the Write, referred to as CMD1. In this case, end-to-end data protection is not enabled and the size of each LBA is 4KB.

To build commands for a fused operation, host software utilizes the next two available adjacent command locations in the appropriate I/O Submission Queue.

The attributes of the Compare command are:

- CMD0.CDW0.OPC is set to 05h for Compare.
- CMD0.CDW0.FUSE is set to 01b indicating that this is the first command of a fused operation.
- CMD0.CDW0.CID is set to a free command identifier.
- CMD0.CDW1.NSID is set to the appropriate namespace.

- If metadata is being used in a separate buffer, then the location of that buffer is specified.
 - If a command uses PRPs then CMD0.MPTR is set to the address of the metadata buffer.
 - If a command uses SGLs then CMD0.MSGLP is set to an SGL segment that describes the metadata buffer.
- The physical address of the first page of the data to compare.
 - If PRPs are used, CMD0.PRP1 is set to the physical address of the first page of the data to compare- and CMD0.PRP2 is set to the physical address of the PRP List. The PRP List is shown in Figure 176 for a PRP List with three entries.
 - If the command uses SGLs, CMD0.SGL1 is set to an appropriate SGL segment descriptor depending on whether more than one descriptor is needed.
- CMD0.CDW10.SLBA is set to the first LBA to compare against. Note that this field also spans Command Dword 11.
- CMD0.CDW12.LR is set to '0' to indicate that the controller should apply all available error recovery means to retrieve the data for comparison.
- CMD0.CDW12.FUA is cleared to '0', indicating that the data may be read from any location, including a DRAM cache, on the device.
- CMD0.CDW12.PRINFO is cleared to 0h since end-to-end protection is not enabled.
- CMD0.CDW12.NLB is set to 3h, indicating that four logical blocks of a size of 4KB each are to be compared against.
- CMD0.CDW14 is cleared to 0h since end-to-end protection is not enabled.
- CMD0.CDW15 is cleared to 0h since end-to-end protection is not enabled.

Figure 176: PRP List Describing Data to Compare

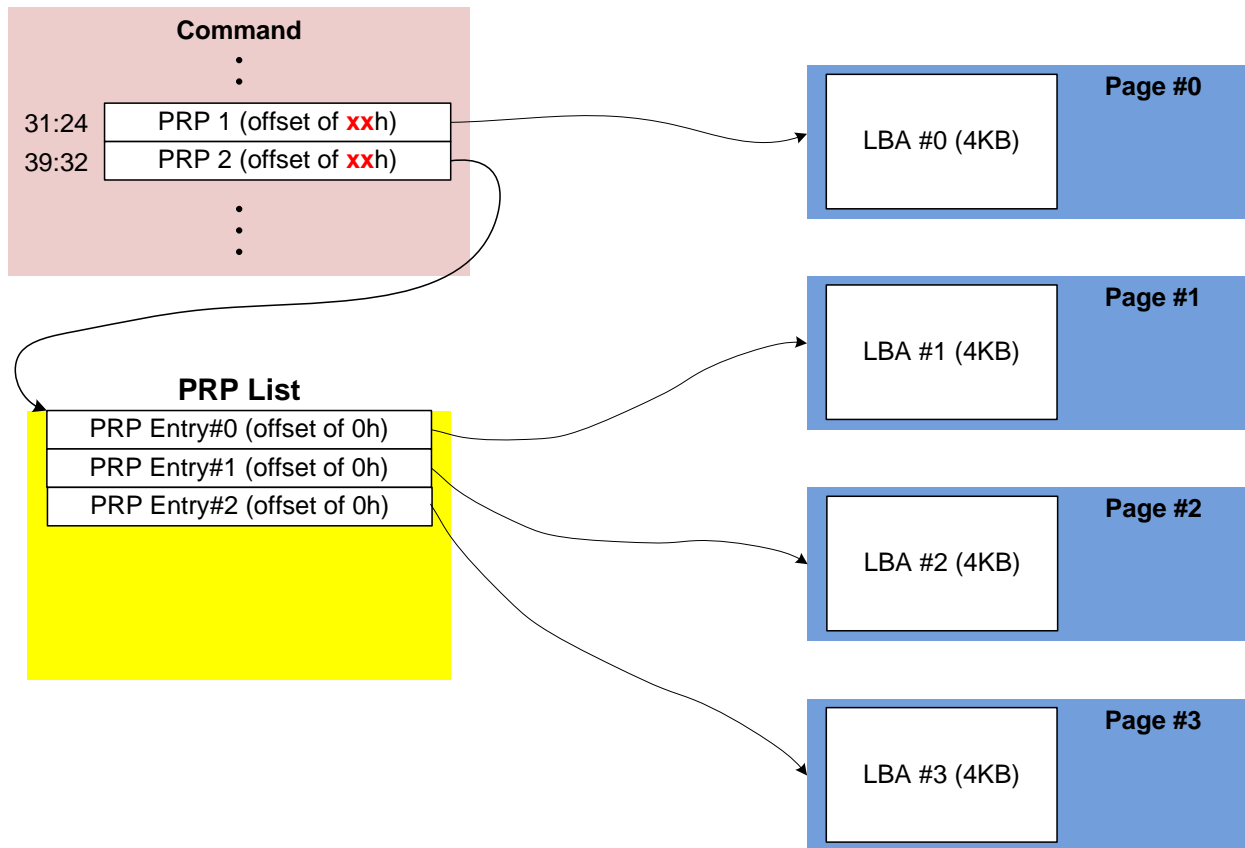

The attributes of the Write command are:

- CMD1.CDW0.OPC is set to 01h for Write.
- CMD1.CDW0.FUSE is set to 10b indicating that this is the second command of a fused operation.
- CMD1.CDW0.CID is set to a free command identifier.
- CMD1.CDW1.NSID is set to the appropriate namespace. This value shall be the same as CMD0.CDW1.NSID.
- If metadata is being used in a separate buffer, then the location of that buffer is specified.
 - If a command uses PRPs then CMD1.MPTR is set to the address of the metadata buffer.
 - If a command uses SGLs then CMD1.MSGLP is set to an SGL segment that describes the metadata buffer.
- The physical address of the first page of data to write is identified.
 - If the command uses PRPs, then CMD1.PRP1 is set to the physical address of the first page of the data to write- and CMD1.PRP2 is set to the physical address of the PRP List. The PRP List includes three entries.
 - If the command uses SGLs, CMD0.SGL1 is set to an appropriate SGL segment descriptor depending on whether more than one descriptor is needed.
- CMD1.CDW10.SLBA is set to the first LBA to compare against. Note that this field also spans Command Dword 11. This value shall be the same as CMD0.CDW10.SLBA.
- CMD1.CDW12.LR is set to '0' to indicate that the controller should apply all available error recovery means to write the data to the NVM.
- CMD1.CDW12.FUA is cleared to '0', indicating that the data may be written to any location, including a DRAM cache, on the device.
- CMD1.CDW12.PRINFO is cleared to 0h since end-to-end protection is not enabled.

- CMD1.CDW12.NLB is set to 4h, indicating that 4h LBAs of a size of 4KB each are to be compared against. This value shall be the same as CMD0.CDW12.NLB.
- CMD1.CDW14 is cleared to 0h since end-to-end protection is not enabled.
- CMD1.CDW15 is cleared to 0h since end-to-end protection is not enabled.

After the commands are built, host software submits the commands for execution by writing the appropriate I/O Submission Queue doorbell (SQxTDBL) to indicate to the controller that these commands are submitted. Note that the doorbell write shall indicate both commands have been submitted at one time.

7.3 Resets

7.3.1 NVM Subsystem Reset

An NVM Subsystem Reset is initiated when:

- Power is applied to the NVM subsystem,
- A value of 4E564D65h (“NVMe”) is written to the N SSR.NSSRC field, or
- A vendor specific event occurs.

When an NVM Subsystem Reset occurs, the entire NVM subsystem is reset. This includes the initiation of a Controller Level Reset on all controllers that make up the NVM subsystem and a transition to the Detect LTSSM state by all PCI Express ports of the NVM subsystem.

The occurrence of an NVM Subsystem Reset while power is applied to the NVM subsystem is reported by the initial value of the CSTS.NSSRO field following the NVM Subsystem Reset. This field may be used by host software to determine if the sudden loss of communication with a controller was due to an NVM Subsystem Reset or some other condition.

The ability for host software to initiate an NVM Subsystem Reset by writing to the N SSR.NSSRC field is an optional capability of a controller indicated by the state of the CAP.NSSRS field. An implementation may protect the NVM subsystem from an inadvertent NVM Subsystem Reset by not providing this capability to one or more controllers that make up the NVM subsystem.

7.3.2 Controller Level

There are five primary controller level reset mechanisms:

- NVM Subsystem Reset
- Conventional Reset (PCI Express Hot, Warm, or Cold reset)
- PCI Express transaction layer Data Link Down status
- Function Level Reset (PCI reset)
- Controller Reset (CC.EN transitions from ‘1’ to ‘0’)

When any of the above resets occur, the following actions are performed:

- All I/O Submission Queues are deleted.
- All I/O Completion Queues are deleted.
- All outstanding I/O commands shall be processed as aborted by host software.
- All outstanding Admin commands shall be processed as aborted by host software.
- The controller is brought to an Idle state. When this is complete, CSTS.RDY is cleared to ‘0’.
- The Admin Queue registers (AQA, ASQ, or ACQ) are not reset as part of a controller reset. All other controller registers defined in section 3 and internal controller state are reset.

In all cases except a Controller Reset, the PCI register space is reset as defined by the PCI Express base specification. Refer to the PCI Express specification for further details.

To continue after a reset, the host shall:

- Update register state as appropriate.
- Set CC.EN to '1'.
- Wait for CSTS.RDY to be set to '1'.
- Configure the controller using Admin commands as needed.
- Create I/O Completion Queues and I/O Submission Queues as needed.
- Proceed with normal I/O operations.

Note that all cases except a Controller Reset result in the controller immediately losing communication with the host. In these cases, the controller is unable to indicate any aborts or update any completion queue entries.

7.3.3 Queue Level

The host may reset and/or reconfigure the Submission and Completion Queues by resetting them. A queue level reset is performed by deleting and then recreating the queue. In this process, the host should wait for all pending commands to the appropriate Submission Queue(s) to complete. To perform the reset, the host submits the Delete I/O Submission Queue or Delete I/O Completion Queue command to the Admin Queue specifying the identifier of the queue to be deleted. After successful command completion of the queue delete operation, the host then recreates the queue by submitting the Create I/O Submission Queue or Create I/O Completion Queue command. As part of the creation operation, the host may modify the attributes of the queue if desired.

The host should ensure that the appropriate Submission Queue or Completion Queue is idle before deleting it. Submitting a queue deletion command causes any pending commands to be aborted by the controller; this may or may not result in a completion queue entry being posted for the aborted command(s). Note that if a queue level reset is performed on a Completion Queue, the Submission Queues that are utilizing the Completion Queue should be reset as part of the same operation. The behavior of a Submission Queue without a corresponding Completion Queue is undefined.

7.4 Queue Management

7.4.1 Queue Allocation

To allocate I/O Submission Queues and I/O Completion Queues, host software follows these steps:

1. Allocates the Admin Submission and Completion Queues by configuring the Admin Queue Attributes (AQA), Admin Submission Queue Base Address (ASQ), and Admin Completion Queue Base Address (ACQ) registers appropriately.
2. Submits a Set Features command for the Number of Queues attribute in order to request the number of I/O Submission Queues and I/O Completion Queues desired. The completion of this Set Features command indicates the number of I/O Submission Queues and I/O Completion Queues allocated.
3. Determines the maximum number of entries supported per queue (CAP.MQES) and whether the queues are required to be physically contiguous (CAP.CQR).
4. Allocates the desired I/O Completion Queues within the limitations of the number allocated by the controller and the queue attributes supported (maximum entries and physically contiguous requirements) by using the Create I/O Completion Queue command.
5. Allocates the desired I/O Submission Queues within the limitations of the number allocated by the controller and the queue attributes supported (maximum entries and physically contiguous requirements) by using the Create I/O Submission Queue command.

At the end of this process, the desired I/O Submission Queues and I/O Completion Queues have been allocated and may be used to complete I/O commands.

7.4.2 Queue Coordination

There is one Admin queue pair associated with multiple I/O queue pairs. The Admin Submission Queue and Completion Queue are used to carry out functions that impact the entire controller. An I/O Submission Queue and Completion Queue may be used to carry out I/O (read/write) operations and may be distributed across CPU cores and threads.

An Admin command may impact one or more I/O queue pairs. The host should ensure that Admin actions are coordinated with threads that are responsible for the I/O queue pairs to avoid unnecessary error conditions. The details of this coordination are outside the scope of this specification.

7.4.3 Queue Abort

To abort a large number of commands, the recommended procedure is to delete and recreate the I/O Submission Queue. Specifically, to abort all commands that are submitted to the Submission Queue host software should issue a Delete I/O Submission Queue command for that queue. After the queue has been successfully deleted, indicating that all commands have been completed or aborted, then host software should recreate the queue by submitting a Create I/O Submission Queue command. Host software may then re-submit any commands desired to the associated I/O Submission Queue.

7.5 Interrupts

The interrupt architecture allows for efficient reporting of interrupts such that the host may service interrupts through the least amount of overhead.

The specification allows the controller to be configured to report interrupts in one of four modes. The four modes are: pin-based interrupt, single message MSI, multiple message MSI, and MSI-X. It is recommended that MSI-X be used whenever possible to enable higher performance, lower latency, and lower CPU utilization for processing interrupts.

Interrupt aggregation, also referred to as interrupt coalescing, mitigates host interrupt overhead by reducing the rate at which interrupt requests are generated by a controller. This reduced host overhead typically comes at the expense of increased latency. Rather than prescribe a specific interrupt aggregation algorithm, this specification defines the mechanisms a host may use to communicate desired interrupt aggregation parameters to a controller and leaves the specific interrupt aggregation algorithm used by a controller as vendor specific. Interrupts associated with the Admin Completion Queue should not be delayed.

The Aggregation Threshold field in the Interrupt Coalescing feature (refer to section 5.12.1.8) specifies the host desired minimum interrupt aggregation threshold on a per vector basis. This value defines the number of Completion Queue entries that when aggregated on a per interrupt vector basis reduces host interrupt processing overhead below a host determined threshold. This value is provided to the controller as a recommendation by the host and a controller is free to generate an interrupt before or after this aggregation threshold is achieved. The specific manner in which this value is used by the interrupt aggregation algorithm implemented by a controller is implementation specific.

The Aggregation Time field in the Interrupt Coalescing feature (refer to section 5.12.1.8) specifies the host desired maximum delay that a controller may apply to a Completion Queue entry before an interrupt is signaled to the host. This value is provided to the controller as a recommendation by the host and a controller is free to generate an interrupt before or after this aggregation time is achieved. A controller may apply this value on a per vector basis or across all vectors. The specific manner in which this value is used by the interrupt aggregation algorithm implemented by a controller is implementation specific.

Although support of the Get Features and Set Features commands associated with interrupt coalescing is required, the manner in which the Aggregation Threshold and Aggregation Time fields are used is implementation specific. For example, an implementation may ignore these fields and not implement interrupt coalescing.

7.5.1 Pin Based, Single MSI, and Multiple MSI Behavior

This is the mode of interrupt operation if any of the following conditions are met:

- Pin based interrupts are being used – MSI (MSICAP.MC.MSIE='0') and MSI-X are disabled
- Single MSI is being used – MSI is enabled (MSICAP.MC.MSIE='1'), MSICAP.MC.MME=0h, and MSI-X is disabled
- Multiple MSI is being used – Multiple-message MSI is enabled (MSICAP.MC.MSIE='1') and (MSICAP.MC.MME=1h) and MSI-X is disabled.

Within the controller there is an interrupt status register (IS) that is not visible to the host. In this mode, the IS register determines whether the PCI interrupt line shall be driven active or an MSI message shall be sent. Each bit in the IS register corresponds to an interrupt vector. The IS bit is set to '1' when the AND of the following conditions is true:

- There is one or more unacknowledged completion queue entries in a Completion Queue that utilizes this interrupt vector;
- The Completion Queue(s) with unacknowledged completion queue entries has interrupts enabled in the "Create I/O Completion Queue" command;
- The corresponding INTM bit exposed to the host is cleared to '0', indicating that the interrupt is not masked.

If MSIs are not enabled, IS[0] being a one causes the PCI interrupt line to be active (electrical '0'). If MSIs are enabled, any change to the IS register that causes an unmasked status bit to transition from zero to one or clearing of a mask bit whose corresponding status bit is set shall cause an MSI to be sent. Therefore, while in wire mode, a single wire remains active, while in MSI mode, several messages may be sent, as each edge triggered event on a port shall cause a new message.

In order to clear an interrupt for a particular interrupt vector, host software shall acknowledge all completion queue entries for Completion Queues associated with the interrupt vector.

Status of IS Register	Pin-based Action	MSI Action
All bits '0' Note: May be caused by corresponding bit(s) in the INTM register being set to '1', masking the corresponding interrupt.	Wire inactive	No action
One or more bits set to '1' Note: May be caused by corresponding bit(s) in the INTM register being cleared to '0', unmasking the corresponding interrupt.	Wire active	New message sent
One or more bits set to '1', new bit gets set to '1'	Wire active	New message sent
One or more bits set to '1', some (but not all) bits in the IS register are cleared (i.e., host software acknowledges some of the associated completion queue entries)	Wire active	New message sent
One or more bits set to '1', all bits in the IS register are cleared (i.e., host software acknowledges all associated completion queue entries)	Wire inactive	No action

7.5.1.1 Host Software Interrupt Handling

It is recommended that host software utilize the Interrupt Mask Set and Interrupt Mask Clear (INTMS/INTMC) registers to efficiently handle interrupts when configured to use pin based or MSI messages. Specifically, within the interrupt service routine, host software should set the appropriate mask register bits to '1' to mask interrupts via the INTMS register. In the deferred procedure call, host software should process all completion queue entries and acknowledge the completion queue entries have been processed by writing the associated CQyHDBL doorbell registers. When all completion queue

entries have been processed, host software should unmask interrupts by clearing the appropriate mask register bits to '0' via the INTMC register.

It is recommended that the MSI interrupt vector associated with the CQ(s) being processed be masked during processing of completion queue entries within the CQ(s) to avoid spurious and/or lost interrupts. For single message or multiple message MSI, the INTMS and INTMC registers should be used to appropriately mask interrupts during completion queue entry processing.

7.5.1.1.1 Interrupt Example (Informative)

An example of the host software flow for processing interrupts is described in this section. This example assumes multiple message MSI is used and that interrupt vector 3 is associated with I/O Completion Queue 3.

1. The controller posts a completion queue entry to I/O Completion Queue 3. The controller sets IS[3] to '1' in its internal IS register. The controller asserts an interrupt to the host.
2. The interrupt service routine (ISR) is triggered.
3. Host software scans all I/O Completion Queues associated with the asserted MSI vector to determine the location of new completion queue entries. In this case, a new completion queue entry has been posted to I/O Completion Queue 3.
4. Host software writes 08h to the INTMS register to mask interrupts for interrupt vector 3, which is associated with I/O Completion Queue 3.
5. The controller masks interrupt vector 3, based on the host write to the INTMS register.
6. Host software schedules a deferred procedure call (DPC) to process the completed command.
7. The deferred procedure call (DPC) is triggered.
8. Host software processes new completion queue entries for I/O Completion Queue 3, completing the associated commands to the OS. Host software updates CQyHDBL to acknowledge the processed completion queue entries and clear the interrupt associated with those completion queue entries. If all completion queue entries have been acknowledged by host software, the controller de-asserts interrupt vector 3.
9. Host software unmask interrupt vector 3 by writing 08h to the INTMC register.

7.5.1.2 Differences Between Pin Based and MSI Interrupts

Single MSI is similar to the pin based interrupt behavior mode. The primary difference is the method of reporting the interrupt. Instead of a communicating the interrupt through an INTx virtual wire, an MSI message is generated to the host. Unlike INTx virtual wire interrupts which are level sensitive, MSI interrupts are edge sensitive.

Pin based and single MSI only use one interrupt vector. Multiple MSI may use up to 32 interrupt vectors.

For multiple MSI, the controller advertises the number of MSI interrupt vectors it requests in the Multiple Message Capable (MMC) field in the Message Signaled Interrupt Message Control (MC) register. The MSICAP.MC.MMC field represents a power-of-2 wrapper on the number of requested vectors. For example, if three vectors are requested, then the MSICAP.MC.MMC field shall be '010' (four vectors).

Multiple-message MSI allows completions to be aggregated on a per vector basis. If sufficient MSI vectors are allocated, each Completion Queue(s) may send its own interrupt message, as opposed to a single message for all completions.

7.5.2 MSI-X Based Behavior

This is the mode of interrupt operation if the MSI-X is being used – (multiple-message) MSI is disabled (MSICAP.MC.MSIE='0') and (MSICAP.MC.MME=0h) and MSI-X is enabled. This is the preferred interrupt behavior to use.

MSI-X, similar to multiple-message MSI, allows completions to be aggregated on a per vector basis. However, the maximum number of vectors is 2K. MSI-X also allows each interrupt to send a unique message data corresponding to the vector.

MSI-X allows completions to be aggregated on a per vector basis. Each Completion Queue(s) may send its own interrupt message, as opposed to a single message for all completions.

When generating an MSI-X message, the following checks occur before generating the message:

- The function mask bit in the MSI-X Message Control register is not set to '1'
- The corresponding vector mask in the MSI-X table structure is not set to '1'

If either of the masks are set, the corresponding pending bit in the MSI-X PBA structure is set to '1' to indicate that an interrupt is pending for that vector. The MSI for that vector is later generated when both the mask bits are reset to '0'.

It is recommended that the interrupt vector associated with the CQ(s) being processed be masked during processing of completion queue entries within the CQ(s) to avoid spurious and/or lost interrupts. The interrupt mask table defined as part of MSI-X should be used to mask interrupts.

7.6 Controller Initialization and Shutdown Processing

This section describes the recommended procedure for initializing the controller and for shutdown processing prior to a power-off condition.

7.6.1 Initialization

The host should perform the following actions in sequence to initialize the controller to begin executing commands:

1. Set the PCI and PCI Express registers described in section 2 appropriately based on the system configuration. This includes configuration of power management features. Pin-based or single-message MSI interrupts should be used until the number of I/O Queues is determined.
2. The Admin Queue should be configured. The Admin Queue is configured by setting the Admin Queue Attributes (AQA), Admin Submission Queue Base Address (ASQ), and Admin Completion Queue Base Address (ACQ) to appropriate values.
3. The controller settings should be configured. Specifically:
 - a. The arbitration mechanism should be selected in CC.AMS.
 - b. The memory page size should be initialized in CC.MPS.
 - c. The I/O Command Set that is to be used should be selected in CC.CSS.
4. The controller should be enabled by setting CC.EN to '1'.
5. The host should wait for the controller to indicate it is ready to process commands. The controller is ready to process commands when CSTS.RDY is set to '1'.
6. The host should determine the configuration of the controller by issuing the Identify command, specifying the Controller data structure. The host should then determine the configuration of each namespace by issuing the Identify command for each namespace, specifying the Namespace data structure.
7. The host should determine the number of I/O Submission Queues and I/O Completion Queues supported using the Set Features command with the Number of Queues feature identifier. After determining the number of I/O Queues, the MSI and/or MSI-X registers should be configured.
8. The host should allocate the appropriate number of I/O Completion Queues based on the number required for the system configuration and the number supported by the controller. The I/O Completion Queues are allocated using the Create I/O Completion Queue command.
9. The host should allocate the appropriate number of I/O Submission Queues based on the number required for the system configuration and the number supported by the controller. The I/O Submission Queues are allocated using the Create I/O Submission Queue command.

10. If the host desires asynchronous notification of error or health events, the host should submit an appropriate number of Asynchronous Event Request commands. This step may be done at any point after the controller signals it is ready (i.e., CSTS.RDY is set to '1').

After performing these steps, the controller may be used for I/O commands.

For exit of the D3 power state, the initialization steps outlined should be followed. In this case, the number of I/O Submission Queues and I/O Completion Queues shall not change, thus step 7 of the initialization sequence is optional.

7.6.1.1 Software Progress Marker

The Software Progress Marker feature, defined in section 5.12.1.12, indicates the number of times pre-boot software has loaded prior to the OS successfully loading. If the pre-boot software load count becomes large, it may indicate there are issues with cached data within the NVM since the OS driver software has not set this field to 0h recently. In this case, the OS driver software may choose to use the NVM more conservatively (e.g., not utilize cached data).

The Software Progress Marker should be updated by both Pre-boot and OS driver software as part of completing initialization.

7.6.2 Shutdown

It is recommended that the host perform an orderly shutdown of the controller by following the procedure in this section when a power-off or shutdown condition is imminent.

The host should perform the following actions in sequence for a normal shutdown:

1. Stop submitting any new I/O commands to the controller and allow any outstanding commands to complete.
2. The host should delete all I/O Submission Queues, using the Delete I/O Submission Queue command. A result of the successful completion of the Delete I/O Submission Queue command is that any remaining commands outstanding are aborted.
3. The host should delete all I/O Completion Queues, using the Delete I/O Completion Queue command.
4. The host should set the Shutdown Notification (CC.SHN) field to 01b to indicate a normal shutdown operation. The controller indicates when shutdown processing is completed by updating the Shutdown Status (CSTS.SHST) field to 10b.

For entry to the D3 power state, the shutdown steps outlined for a normal shutdown should be followed.

The host should perform the following actions in sequence for an abrupt shutdown:

1. Stop submitting any new I/O commands to the controller.
2. The host should set the Shutdown Notification (CC.SHN) field to 10b to indicate an abrupt shutdown operation. The controller indicates when shutdown processing is completed by updating the Shutdown Status (CSTS.SHST) field to 10b.

It is recommended that the host wait a minimum of one second for the shutdown operations to complete. It is not recommended to disable the controller via the CC.EN field. This causes a controller reset condition which may impact the time required to complete shutdown processing.

To start executing commands on the controller after a shutdown operation, a reset (CC.EN cleared from '1' to '0') is required. The initialization sequence should then be executed.

It is an implementation choice whether the host aborts all outstanding commands to the Admin Queue prior to the shutdown. The only commands that should be outstanding to the Admin Queue at shutdown are Asynchronous Event Request commands.

7.7 Feature Values

The Get Features command, defined in section 5.9, and Set Features command, defined in section 5.12, may be used to read and modify operating parameters of the controller. The operating parameters are grouped and identified by Feature Identifiers. Each Feature Identifier contains one or more attributes that may affect the behavior of the Feature.

If bit 4 is set to '1' in the Optional NVM Command Support field of the Identify Controller Data structure in Figure 65 then for each Feature, there are three settings: default, saveable, and current. If bit 4 is cleared to '0' in the Optional NVM Command Support field of the Identify Controller Data structure in Figure 65 then the controller only supports a current and default value for each Feature. In this case, the current value may be persistent across power states based on the information specified in Figure 89 and Figure 90.

The default value for each Feature is vendor specific and is not changeable; it is set by the manufacturer. The saveable value is the value that the Feature has after a power on or reset event. The controller may not support a saveable value for a Feature; this is discovered by using the 'supported capabilities' value in the Select field in Get Features. If the controller does not support a saveable value for a Feature, then the default value is used after a power on or reset event. The current value is the value actively in use by the controller for a Feature after a Set Features command completes.

Set Features may be used to modify the saveable and current value for a Feature. Get Features may be used to read the default, saveable, and current value for a Feature. If the controller does not support a saveable value for a Feature, then the default value is returned for the saveable value in Get Features.

Feature settings may apply to the entire controller (and all associated namespaces) or may apply to each namespace individually. To change or retrieve a value that applies to the controller and all associated namespaces, host software sets CDW1.NSID to 0h or FFFFFFFFh in the Set Features or Get Features command. Features that are not namespace specific shall have the CDW1.NSID field set to 0h. To change or retrieve a value that applies to a specific namespace, host software sets CDW1.NSID to the identifier of that namespace in the Set Features or Get Features command. If host software specifies a valid CDW1.NSID value that is not 0h or FFFFFFFFh and the Feature is not namespace specific, then the controller returns the Feature value that applies to the entire controller.

If bit 4 is set to '1' in the Optional NVM Command Support field of the Identify Controller Data structure in Figure 82, then any Feature Identifier may be namespace specific depending on the implementation. Host software may discover if a Feature Identifier is namespace specific by using the 'supported capabilities' value in the Select field in Get Features. If bit 4 is cleared to '0' in the Optional NVM Command Support field of the Identify Controller Data structure in Figure 82, then LBA Range Type is the only Feature Identifier that is namespace specific.

There are mandatory and optional Feature Identifiers defined in Figure 89 and Figure 90. If a Get Features command or Set Features command is processed that specifies a Feature Identifier that is not supported, then the controller shall abort the command with a status of Invalid Field in Command.

7.8 Unique Identifier

Information is returned in the Identify Controller data structure that may be used to construct a unique identifier. Specifically, the PCI Vendor ID, Serial Number, and Model Number fields when combined shall form a globally unique value that identifies the NVM subsystem. The mechanism used by the vendor to assign Serial Number and Model Number values to ensure uniqueness is outside the scope of this specification.

An NVM subsystem may contain multiple controllers and all of the controllers that make up an NVM subsystem share the same NVM subsystem identifier (i.e., PCI Vendor ID, Serial Number, and Model Number). The Controller ID (CNTLID) value returned in the Identify Controller data structure may be used to uniquely identify a controller within an NVM subsystem. The Controller ID value when combined with the NVM subsystem identifier forms a globally unique value that identifies the controller. The mechanism used by the vendor to assign Controller ID values is outside the scope of this specification.

Each namespace in an NVM subsystem contains a globally unique identifier that is returned in the IEEE Extended Unique Identifier (EUI64) value of the Identify Namespace data structure.

8 Features

8.1 Firmware Update Process

A firmware update is a four step process.

1. The firmware is downloaded to the controller. This is accomplished by using the Firmware Image Download command. There may be multiple portions of the firmware image to download, thus the offset for each portion of the firmware image being downloaded is specified in the Firmware Image Download command.
2. After the firmware is downloaded to the controller, the next step is for the host to submit a Firmware Activate command. The Firmware Activate command verifies that the last firmware image downloaded is valid and commits that image to the firmware slot indicated for future use. A firmware image that does not start at offset zero, contains gaps, or contains overlapping regions is considered invalid. A controller may employ additional vendor specific means (e.g., checksum, CRC, cryptographic hash or a digital signature) to determine the validity of a firmware image.
 - a. The Firmware Activate command may also be used to activate a firmware image associated with a previously activated firmware slot.
3. The last step is to perform a reset that then causes the firmware image specified in the Firmware Activate command to be applied. The reset may be an NVM Subsystem Reset, Conventional Reset, Function Level Reset, or Controller Reset (CC.EN transitions from '1' to '0').
 - a. In some cases a Conventional Reset or NVM Subsystem Reset is required to activate a Firmware image. This requirement is indicated by Firmware Activate command specific status (refer to section 5.7.1).
4. After the reset has completed, host software re-initializes the controller. This includes re-allocating I/O Submission and Completion Queues. Refer to section 7.6.1.

If a D3 cold condition occurs during the firmware activation process, the controller may resume operation with either the old or new firmware.

If the firmware is not able to be successfully loaded following a reset, then the controller shall revert to the previously active firmware image or the baseline read-only firmware image, if available, and indicate the failure as an asynchronous event with a Firmware Image Load Error.

Host software shall not update multiple firmware images simultaneously. A firmware image shall be committed to the firmware slot using Firmware Activate before downloading additional firmware images. If the controller does not receive a Firmware Activate command, then it shall delete the portion(s) of the new image in the case of a reset.

8.2 Metadata Handling

The controller may support metadata per logical block. Metadata is additional data allocated on a per logical block basis. There is no requirement for how the host makes use of the metadata area. One of the most common usages for metadata is to convey end-to-end protection information.

The metadata may be transferred by the controller to or from the host in one of two ways. The mechanism used is selected as part of the Format NVM command.

The first mechanism for transferring the metadata is as a contiguous part of the logical block that it is associated with. The metadata is transferred at the end of the associated logical block, forming an extended logical block. This mechanism is illustrated in Figure 177. In this case, both the logical block data and logical block metadata are pointed to by the PRP1 and PRP2 pointers (or SGL Entry 1 if SGLs are used).

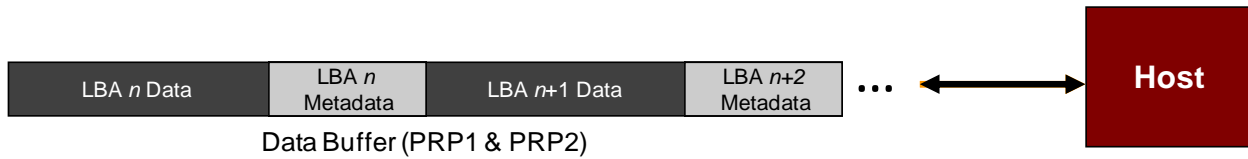
Figure 177: Metadata – Contiguous with LBA Data, Forming Extended LBA

The second mechanism for transferring the metadata is as a separate contiguous buffer of data. This mechanism is illustrated in Figure 178. In this case, the metadata is pointed to with the Metadata Pointer (or Metadata SGL Segment Pointer if SGLs are used), while the logical block data is pointed to by the PRP1 and PRP2 pointers (or SGL Entry 1 if SGLs are used). The metadata is required to be physically contiguous in this case since there is only one Metadata Pointer.

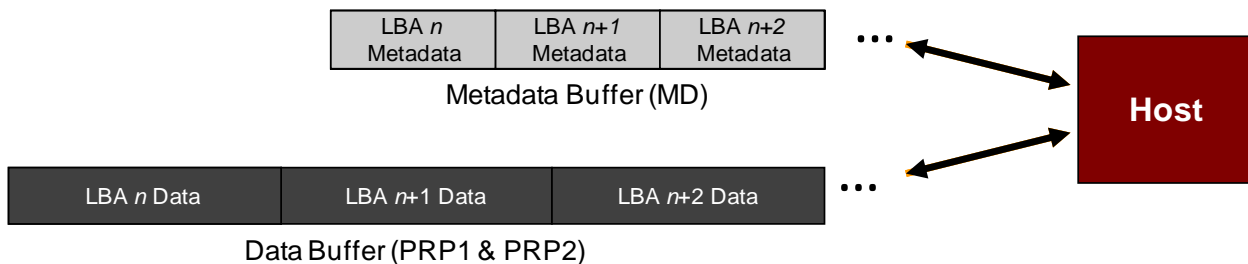
Figure 178: Metadata – Transferred as Separate Buffer

One of the transfer mechanisms shall be selected for each namespace when it is formatted; transferring a portion of metadata with one mechanism and a portion with the other mechanism is not supported.

If end-to-end data protection is used, then the Protection Information field for each logical block is contained in the metadata.

8.3 End-to-end Data Protection (Optional)

To provide robust data protection from the application to the NVM media and back to the application itself, end-to-end data protection may be used. If this optional mechanism is enabled, then additional protection information (e.g. CRC) is added to the logical block that may be evaluated by the controller and/or host software to determine the integrity of the logical block. This additional protection information, if present, is either the first eight bytes of metadata or the last eight bytes of metadata, based on the format of the namespace. For metadata formats with more than eight bytes, if the protection information is contained within the first eight bytes of metadata, then the CRC does not cover any metadata bytes. For metadata formats with more than eight bytes, if the protection information is contained within the last eight bytes of metadata, then the CRC covers all metadata bytes up to but excluding these last eight bytes. As described in section 8.2, metadata and hence this protection information may be configured to be contiguous with the logical block data or stored in a separate buffer.

The most commonly used data protection mechanisms in Enterprise implementations are Data Integrity Field (DIF), defined in the SCSI Block Commands – 3 reference (SBC-3), and the Data Integrity Extension (DIX). The primary difference between these two mechanisms is the location of the protection information. In DIF the protection information is contiguous with the logical block data and creates an extended logical block, while in DIX the protection information is stored in a separate buffer. The end-to-end data protection mechanism defined by this specification is functionally compatible with both DIF and DIX. DIF functionality is achieved by configuring the metadata to be contiguous with logical block data

(as shown in Figure 177, while DIX functionality is achieved by configuring the metadata and data to be in separate buffers (as shown in Figure 178).

NVM Express supports the same end-to-end protection types as DIF. The type of end-to-end data protection (Type 1, Type 2, or Type 3) is selected when a namespace is formatted and is reported in the Identify Namespace data structure.

The Protection Information format is shown in Figure 179 and is contained in the metadata associated with each logical block. The Guard field contains a CRC-16 computed over the logical block data. In addition to a CRC-16, DIX also specifies an optional IP checksum that is not supported by NVM Express. The Application Tag is an opaque data field not interpreted by the controller and that may be used to disable checking of protection information. The Reference Tag associates logical block data with an address and protects against misdirected or out-of-order logical block transfer. Like the Application Tag, the Reference Tag may also be used to disable checking of protection information.

Figure 179: Protection Information Format



The protection information processing performed as a side effect of Read and Write commands is controlled by the Protection Information Action (PRACT) bit in the command. Figure 180 illustrates the protection information processing that may occur as a side effect of a Write command. If the namespace is not formatted with end-to-end data protection, then logical block data and any optional metadata is transferred from the host to the NVM with no processing. If the namespace was formatted with protection information and the PRACT bit is cleared to '0', then logical block data and metadata containing protection information are transferred from the host to NVM. As the logical block and metadata passes through the controller, the protection information is checked. If a protection information check error is detected, the command completes with the status code of the error detected (i.e., End-to-end Guard Check, End-to-end Application Tag Check or End-to-end Reference Tag Check). If the namespace was formatted with protection information and the PRACT bit is set to '1', then logical block data is transferred from the host to the controller. The controller inserts protection information and the logical block data and metadata containing protection information are written to NVM.

When there is additional metadata, the protection information may be transferred as the first eight bytes of metadata or the last eight bytes of metadata. The location of the protection information is configured when the namespace is formatted. In this case, the protection information replaces the first eight or last eight bytes of metadata (i.e., the metadata field remains the same size in NVM as that in the host).

Figure 180: Write Command Protection Information Processing

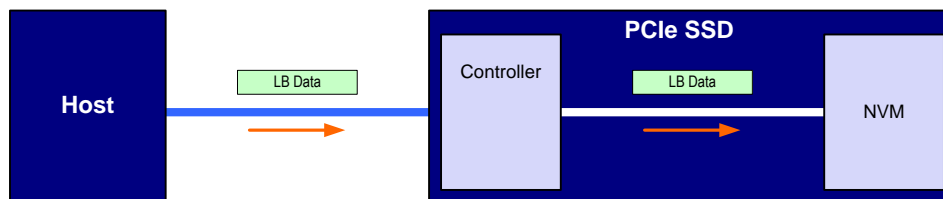

(a) No Protection Information

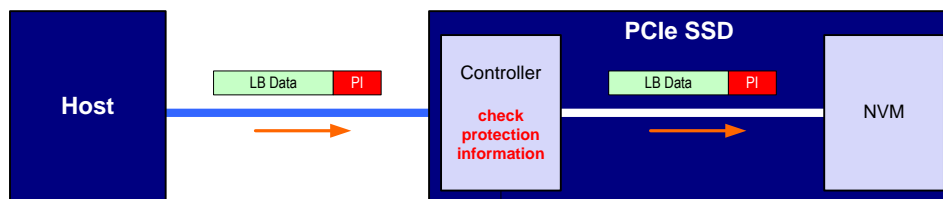

(b) Protection Information with PRACT bit cleared to '0' (i.e., pass)

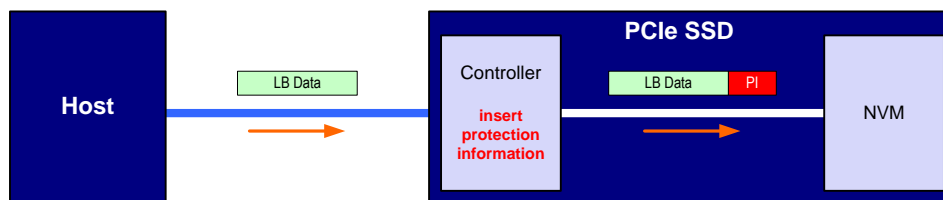

(c) Protection Information with PRACT bit set to '1' (i.e., insert)

Compare command processing is the same as that for a Read command except that no data is transferred to the host.

Figure 181 illustrates the protection information processing that may occur as a side effect of Read command processing. The processing parallels Write command processing with the exception that logical block data flows in the opposite direction. When the PRACT bit is cleared to '0' and the namespace was formatted with protection information, logical block data and metadata are transferred from NVM to the host and checked by the controller. When the PRACT bit is set to '1' and the namespace was formatted with protection information, logical block data and metadata are transferred from the NVM to the controller. The controller checks the protection information and then removes it from the metadata before passing the LBA to the host. If the namespace format contains metadata beyond the protection information, then the protection information is not stripped regardless of the state of the PRACT bit (i.e., the metadata field remains the same size in the host as that in NVM).

Figure 181: Read Command Protection Information Processing

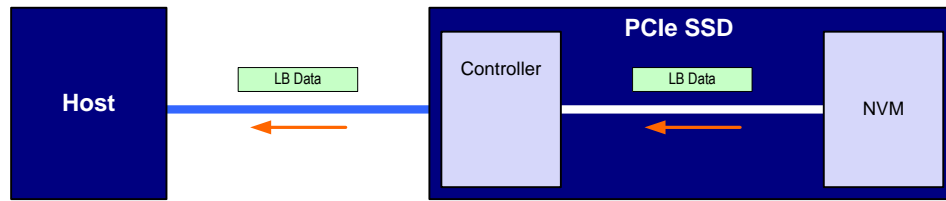

(a) No Protection Information

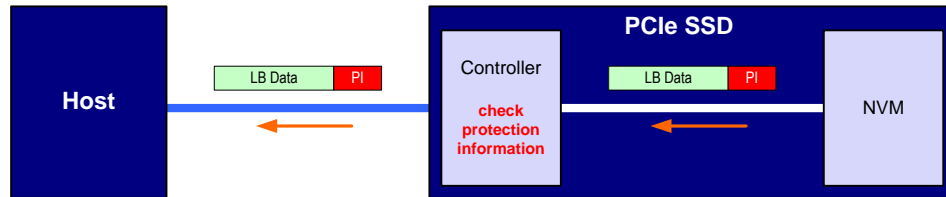

(b) Protection Information with PRACT bit cleared to '0' (i.e., pass)

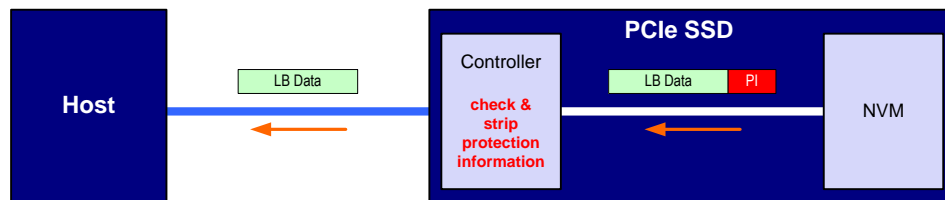

(c) Protection Information with PRACT bit set to '1' (i.e., strip)

Protection processing for fused operations is the same as those for the individual commands that make up the fused operation.

Checking of protection information consists of the following operations performed by the controller. If bit 2 of the Protection Information Check (PRCHK) field of the command is set to '1', then the controller compares the protection information Guard field to the CRC-16 computed over the logical block data. If bit 1 of the PRCHK field is set to '1', then the controller compares unmasked bits in the protection information Application Tag field to the Logical Block Application Tag (LBAT) field in the command. A bit in the protection information Application Tag field is masked if the corresponding bit is cleared to '0' in the Logical Block Application Tag Mask (LBATM) field of the command. If bit 0 of the PRCHK field is set to '1', then the controller compares the protection information Reference Tag field to the computed reference tag. The value of the computed reference tag for the first LBA of the command is the value contained in the Initial Logical Block Reference Tag (ILBRT) field in the command. The computed reference tag is incremented for each subsequent logical block. Unlike DIF Type 1 protection which implicitly uses the least significant four bytes of the LBA, The controller always uses the ILBRT field and requires host software to initialize the ILBRT field to the least significant four bytes of the LBA when Type 1 protection is used.

Protection checking may be disabled as a side effect of the value of the protection information Application Tag and Reference Tag fields regardless of the state of the PRCHK field in the command. If the namespace is formatted for Type 1 or Type 2 protection, then all protection information checks are disabled regardless of the state of the PRCHK field when the protection information Application Tag has a value of FFFFh. If the namespace is formatted for Type 3 protection, then all protection information checks are disabled regardless of the state of the PRCHK field when the protection information

Application Tag has a value of FFFFh and the protection information Reference Tag has a value of FFFF_FFFFh.

Inserted protection information consists of the computed CRC-16 in the Guard field, the LBAT field value in the Application Tag, and the computed reference tag in the Reference Tag field.

8.4 Power Management

The power management capability allows the host to manage NVM subsystem power statically or dynamically. Static power management consists of the host determining the maximum power that may be allocated to an NVM subsystem and setting the NVM Express power state to one that consumes this amount of power or less. Dynamic power management is illustrated in Figure 182 and consists of the host modifying the NVM Express power state to best satisfy changing power and performance objectives. This power management mechanism is meant to complement and not replace autonomous power management performed by a controller.

Figure 182: Dynamic Power Management

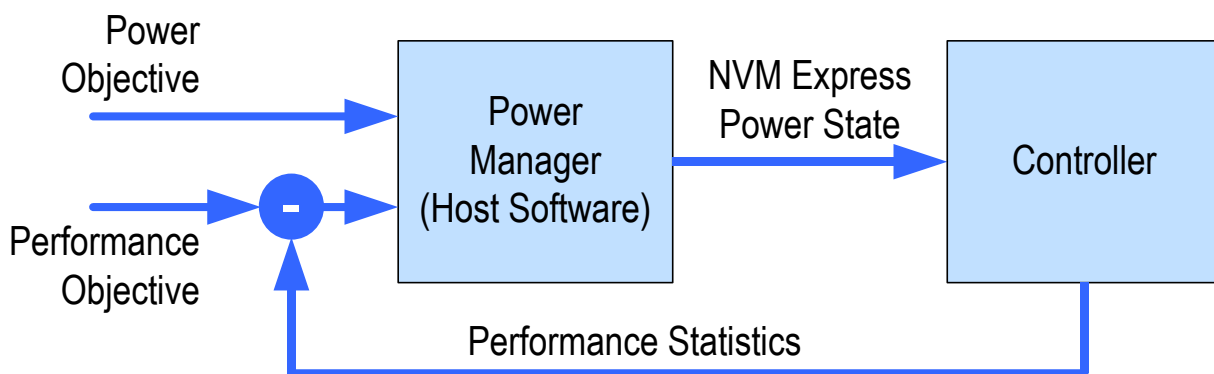

The number of power states implemented by a controller is returned in the Number of Power States Supported (NPSS) field in the Identify Controller data structure. A controller shall support at least one power state and may optionally support up to a total of 32 power states. Power states are contiguously numbered starting with zero such that each subsequent power state consumes less or equal power than the previous state. Thus, power state zero indicates the maximum power that the NVM subsystem is capable of consuming.

Associated with each power state is a Power State Descriptor in the Identify Controller data structure (see Figure 83). The descriptors for all implemented power states may be viewed as forming a table as shown in Figure 183 for a controller with seven implemented power states. The Maximum Power (MP) field indicates the instantaneous maximum power that may be consumed in that state. The controller may employ autonomous power management techniques to reduce power consumption below this level, but under no circumstances is power allowed to exceed this level.

Figure 183: Example Power State Descriptor Table

Power State	Maximum Power (MP)	Entry Latency (ENTLAT)	Exit Latency (EXLAT)	Relative Read Throughput (RRT)	Relative Read Latency (RRL)	Relative Write Throughput (RWT)	Relative Write Latency (RWL)
0	25 W	5 μ s	5 μ s	0	0	0	0
1	18 W	5 μ s	7 μ s	0	0	1	0
2	18 W	5 μ s	8 μ s	1	0	0	0
3	15 W	20 μ s	15 μ s	2	0	2	0
4	10 W	20 μ s	30 μ s	1	1	3	0
5	8 W	50 μ s	50 μ s	2	2	4	0
6	5 W	20 μ s	5000 μ s	4	3	5	1

The host may dynamically modify the power state using the Set Features command and determine the current power state using the Get Features command. The host may directly transition between any two supported power states. The Entry Latency (ENTLAT) field in the power management descriptor indicates the maximum amount of time in microseconds that it takes to enter that power state and the Exit Latency (EXLAT) field indicates that maximum amount of time in microseconds that it takes to exit that state. The maximum amount of time to transition between any two power states is equal to the sum of the old state's exit latency and the new state's entry latency. The host is not required to wait for a previously submitted power state transition to complete before initiating a new transition. The maximum amount of time for a sequence of power state transitions to complete is equal to the sum of transition times for each individual power state transition in the sequence.

Associated with each power state descriptor are Relative Read Throughput (RRT), Relative Write Throughput (RWT), Relative Read Latency (RRL) and Relative Write Latency (RWL) fields that provide the host with an indication of relative performance in that power state. Relative performance values provide an ordering of performance characteristics between power states. Relative performance values may repeat, may be skipped, and may be assigned in any order (i.e., increasing power states need not have increasing relative performance values).

A lower relative performance value indicates better performance (e.g., higher throughput or lower latency). For example, in Figure 182 power state 1 has higher read throughput than power state 2, and power states 0 through 3 all have the same read latency. Relative performance ordering is only with respect to a single performance characteristic. Thus, although the relative read throughput value of one power state may equal the relative write throughput value of another power state, this does not imply that the actual read and write performance of these two power states are equal.

The default NVM Express power state is implementation specific and shall correspond to a state that does not consume more power than the lowest value specified in the form factor specification used by the PCI Express SSD. The host shall never select a power state that consumes more power than the PCI Express slot power limit control value expressed by the Captured Slot Power Limit Value (CSPLV) and Captured Slot Power Limit Scale (CSPLS) fields of the PCI Express Device Capabilities (PXDCAP) register. Hosts that do not dynamically manage power should set the power state to the lowest numbered state that satisfies the PCI Express slot power limit control value.

If a controller implements the PCI Express Dynamic Power Allocation (DPA) capability and it is enabled (i.e., the Substate Control Enable bit is set), then the maximum power that may be consumed by the NVM subsystem is equal to the minimum value specified by the DPA substate or the NVM Express power state, whichever is lower.

8.4.1 Autonomous Power State Transitions

The controller may support autonomous power state transitions, as indicated in the Identify Controller data structure in Figure 82. Autonomous power state transitions provide a mechanism for the host to

configure the device to automatically transition between power states on certain conditions without software intervention.

The entry condition to transition to the Idle Transition Power State is that the controller has been in idle for a continuous period of time exceeding the Idle Time Prior to Transition time specified. The controller is idle when there are no commands outstanding to any I/O Submission Queue. The power state to transition to shall be a non-operational power state (a non-operational power state may autonomously transition to another non-operational power state). In a non-operational power state, no I/O commands are processed by the controller.

Following an autonomous power state transition to a non-operational state, the controller shall autonomously transition back to the last operational power state when an I/O Submission Queue Tail Doorbell is written.

Servicing a memory-mapped I/O (MMIO) or configuration register access may cause the controller power to exceed that advertised by the non-operational power state while the access is being serviced, however, the controller shall logically remain in the non-operational power state. Processing a command submitted to the Admin Submission Queue may also cause the controller power to exceed that advertised by the non-operational power state while the command is processed, however, the controller shall logically remain in the current power state unless there is an explicit power state transition requested by a Set Features command with the Power Management feature identifier. When servicing a register access or an Admin command, the controller shall not exceed the maximum power advertised for the last operational power state.

8.5 Single Root I/O Virtualization and Sharing (SR-IOV)

The PCI-SIG Single Root I/O Virtualization and Sharing Specification (SR-IOV) defines extensions to PCI Express that allow multiple System Images (SI), such as virtual machines running on a hypervisor, to share PCI hardware resources. The primary benefit of SR-IOV is that it eliminates the hypervisor from participating in I/O operations which may be a significant factor limiting storage performance in some virtualized environments and allows direct SI access to PCI hardware resources.

While the details associated with implementing a controller that supports SR-IOV are outside the scope of this specification, such a controller shall implement fully compliant NVM Express Virtual Functions (VFs). This ensures that the same host software developed for non-virtualized environments is capable of running unmodified within an SI. No such requirement exists for the Physical Function (PF).

Note: Some settings for features specified with Set Features for a VF may be overridden by the value specified for the associated feature in the PF.

All other aspects associated with SR-IOV such as the architecture of the PF, mapping of namespaces to VFs, and sharing of namespaces between VFs are outside the scope of this specification.

8.6 Doorbell Stride for Software Emulation

The doorbell stride, specified in CAP.DSTRD, may be used to separate doorbells by a number of bytes in memory space. The doorbell stride is a number of bytes equal to $(2^{(2 + \text{CAP.DSTRD})})$. This is useful in software emulation of an NVM Express controller. In this case, a software thread is monitoring doorbell notifications. The software thread may be made more efficient by monitoring one doorbell per discrete cacheline or utilize the monitor/mwait CPU instructions. For hardware implementations of NVM Express, the expected doorbell stride value is 0h.

8.7 Standard Vendor Specific Command Format

Controllers may support the standard Vendor Specific command format defined in Figure 13. Host storage drivers may use the Number of Dwords fields to ensure that the application is not corrupting physical memory (e.g. overflowing a data buffer). The controller indicates support of this format in the

Identify Controller data structure in Figure 82; refer to Admin Vendor Specific Command Configuration and NVM Vendor Specific Command Configuration.

8.8 Reservations (Optional)

NVM Express reservations provide capabilities that may be utilized by two or more hosts to coordinate access to a shared namespace. The protocol and manner in which these capabilities are used is outside the scope of this specification. Incorrect application of these capabilities may corrupt data and/or otherwise impair system operation.

A reservation on a namespace restricts hosts access to that namespace. If a host submits a command to a namespace in the presence of a reservation and lacks sufficient rights, then the command is aborted by the controller with a status of Reservation Conflict. Capabilities are provided that allow recovery from a reservation on a namespace held by a failing or uncooperative host.

Figure 184: Example Multi-Host System

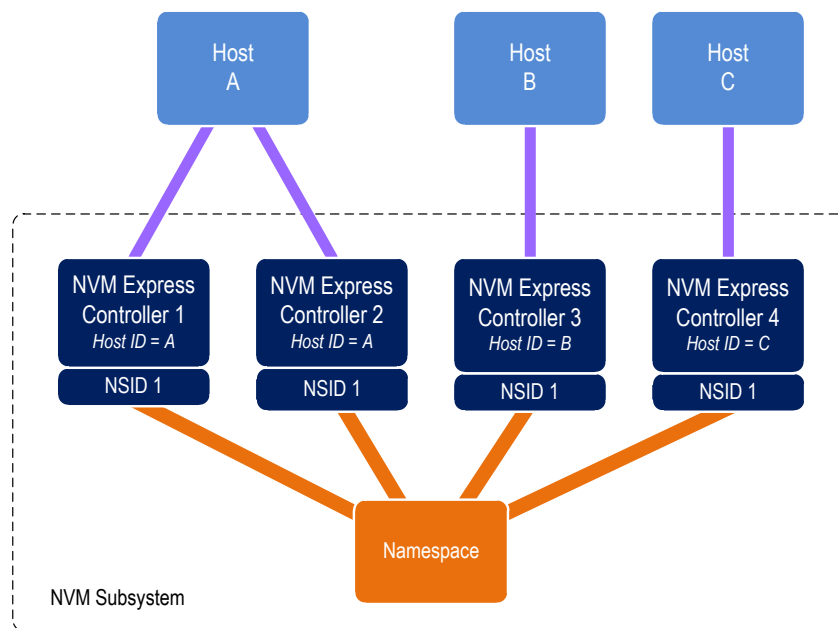

A reservation requires an association between a host and a namespace. As shown in Figure 184, each controller in a multi-path I/O and namespace sharing environment is associated with exactly one host. While it is possible to construct systems where two or more hosts share a single controller, such usage is outside the scope of this specification.

A host may be associated with multiple controllers. In Figure 184 host A is associated with two controllers while hosts B and C are each associated with a single controller. A host registers a Host Identifier (Host Identifier) with each controller with which it is associated using a Set Features command prior to performing any operations associated with reservations. The Host Identifier allows the NVM Subsystem to identify controllers associated with the same host and preserve reservation properties across these controllers (i.e., a host issued command has the same reservation rights no matter which controller associated with the host processes the command).

Support for reservations by a namespace or controller is optional. A namespace indicates support for reservations by reporting a non-zero value in the Reservation Capabilities (RESCAP) field in the Identify Namespace data structure. A controller indicates support for reservations through the Optional NVM Command Support (ONCS) field in the Identify Controller data structure. If a host submits a command associated with reservations (i.e., Reservation Report, Reservation Register, Reservation Acquire, and

Reservation Release) to a controller or a namespace that do not both support reservations, then the command is aborted by the controller with status Invalid Command Opcode.

Controllers that make up an NVM Subsystem shall all have the same support for reservations. Although strongly encouraged, namespaces that make up an NVM Subsystem are not all required to have the same support for reservations. For example, some namespaces within a single controller may support reservations while others do not, or the supported reservation types may differ among namespaces. If a controller supports reservations, then the controller shall:

- Indicate support for reservations by returning a '1' in bit 5 of the Optional NVM Command Support (ONCS) field in the Identify Controller data structure;
- Support the Reservation Report command, Reservation Register command, Reservation Acquire command, and Reservation Release command;
- Support the Reservation Notification log page;
- Support the Reservation Log Page Available asynchronous events;
- Support the Reservation Notification Mask Feature;
- Support the Host Identifier Feature; and
- Support the Reservation Persistence Feature;

If a namespace supports reservations, then the namespace shall:

- Report a non-zero value in the Reservation Capabilities (RESCAP) field in the Identify Namespace data structure.
- Support Persist Through Power Loss (PTPL) state; and
- Support sufficient resources to allow a host to successfully register a reservation key on every controller in the NVM Subsystem with access to the shared namespace (i.e., a Reservation Register command shall never fail due to lack of resources).

8.8.1 Reservation Notifications

There are three types of reservation notifications: registration preempted, reservation released, and reservation preempted. Conditions that cause a reservation notification to occur are described in the following sections. A Reservation Notification log page is created whenever an unmasked reservation notification occurs on a namespace associated with the controller (see section 5.10.1.4.1). Reservation notifications may be masked from generating a reservation log page on a per reservation notification type and per namespace ID basis through the Reservation Notification Mask feature (see section 5.12.1.14). A host may use the Asynchronous Event Request command to be notified of the presence of one or more available Reservation Notification log pages (see section 5.2).

8.8.2 Reservation Notifications

Prior to establishing a reservation on a namespace, a host shall become a registrant of that namespace by registering a reservation key. This reservation key may be used as a means of identifying the registrant (host), authenticating the registrant, and preempting the registrant should the registrant fail or become uncooperative. The value of the reservation key used by a host and the method used to select its value is outside the scope of this specification.

Registering a reservation key with a namespace creates an association between a host and a namespace. A host that is a registrant of a namespace may use any controller with which it is associated (i.e., that has the same Host Identifier, refer to section 5.12.1.13) to access that namespace as a registrant. Thus, a host need only register on a single controller in order to become a registrant of the namespace on all controllers in the NVM Subsystem that have access to the namespace and are associated with the host.

A host registers a reservation key by executing a Reservation Register command on the namespace with the Reservation Register Action (RREGA) field set to 000b (i.e., Register Reservation Key) and supplying a reservation key in the New Reservation Key (NRKEY) field.

A host that is a registrant of a namespace may register the same reservation key value multiple times with the namespace on the same or different controllers. It is an error for a host that is already a registrant of a namespace to register with the same namespace using a different registration key value (i.e., the command is aborted with status Reservation Conflict). There are no restrictions on the reservation key value used by hosts with different Host Identifiers. For example, multiple hosts may all register with the same reservation key value.

A host that is a registrant of a namespace may replace its existing reservation key by executing a Reservation Register command on the namespace with the RREGA field set to 010b (i.e., Replace Reservation Key), supplying the current reservation key in the Current Reservation Key (CRKEY) field, and the new reservation key in the NRKEY field. If the contents of the CRKEY field do not match the key currently associated with the host, then the command is aborted with a status of Reservation Conflict. A host may replace its reservation key without regard to its registration status or current reservation key value by setting the Ignore Existing Key (IEKEY) bit to '1' in the Reservation Register command. Replacing a reservation key has no effect on any reservation that may be held on the namespace.

8.8.3 Reservation Types

NVM Express supports six types of reservations:

- Write Exclusive,
- Exclusive Access,
- Write Exclusive - Registrants Only,
- Exclusive Access - Registrants Only,
- Write Exclusive - All Registrants, and
- Exclusive Access - All Registrants.

Figure 185: Command Behavior in the Presence of a Reservation

Reservation Type	Reservation Holder		Registrant		Non-Registrant		Reservation Holder Definition
	Read	Write	Read	Write	Read	Write	
Write Exclusive	Y	Y	Y	N	Y	N	One Reservation Holder
Exclusive Access	Y	Y	N	N	N	N	One Reservation Holder
Write Exclusive - Registrants Only	Y	Y	Y	Y	Y	N	One Reservation Holder
Exclusive Access - Registrants Only	Y	Y	Y	Y	N	N	One Reservation Holder
Write Exclusive - All Registrants	Y	Y	Y	Y	Y	N	All Registrants are Reservation Holders
Exclusive Access - All Registrants	Y	Y	Y	Y	N	N	All Registrants are Reservation Holders

The differences between these reservation types are: the type of access that is excluded (i.e., writes or all accesses), whether registrants have the same access rights as the reservation holder, and whether registrants are also considered to be reservation holders. These differences are summarized in Figure 185 and the specific behavior for each NVM Express command is shown in Figure 186.

Reservations and registrations persist across all Controller Level Resets and all NVM Subsystem Resets except reset due to power loss. A reservation may be optionally configured to be retained across a reset due to power loss using the Persist Through Power Loss State (PTPLS). A Persist Through Power Loss

State (PTPLS) is associated with each namespace that supports reservations and may be modified as a side effect of a Reservation Register command or a Set Features command.

Figure 186: Command Behavior in the Presence of a Reservation

NVMe Command	Write Exclusive Reservation		Exclusive Access Reservation		Write Exclusive Registrants Only or Write Exclusive All Registrants Reservation		Exclusive Access Registrants Only or Exclusive Access All Registrants Reservation	
	Non-Registrant	Registrant	Non-Registrant	Registrant	Non-Registrant	Registrant	Non-Registrant	Registrant
NVM Read Command Group: Read Compare Security Receive (Admin)	A	A	C	C	A	A	C	A
NVM Write Command Group: Write Write Uncorrectable Dataset Management Flush Format NVM (Admin) Security Send (Admin)	C	C	C	C	C	A	C	A
Reservation Acquire - Acquire	C	C	C	C	C	C	C	C
Reservation Release Reservation Acquire - Preempt Reservation Acquire - Preempt and Abort	C	A	C	A	C	A	C	A
All other commands ¹	A	A	A	A	A	A	A	A
Key: A definition: A=Allowed, command processed normally by the controller C definition: C=Conflict, command aborted by the controller with status Reservation Conflict Notes: 1. The behavior of a vendor specific command is vendor specific.								

8.8.4 Unregistering

A host that is a registrant of a namespace may unregister with the namespace by executing a Reservation Register command on the namespace with the RREGA field set to 001b (i.e., Unregister Reservation Key) and supplying its current reservation key in the CRKEY field. If the contents of the CRKEY field do not match the key currently associated with the host, then the command is aborted with a status of Reservation Conflict. If the host is not a registrant, then the command is aborted with a status of Reservation Conflict.

Successful completion of an unregister operation causes the host to no longer be a registrant of that namespace. A host may unregister without regard to its current reservation key value by setting the IEKEY bit to '1' in the Reservation Register command.

Unregistering by a host may cause a reservation held by the host to be released. If a host is the last remaining reservation holder (i.e., the reservation type is Write Exclusive - All Registrants or Exclusive Access - All Registrants) or is the only reservation holder, then the reservation is released when the host unregisters.

If a reservation is released and the type of the released reservation was Write Exclusive - Registrants Only or Exclusive Access - Registrants Only, then a reservation released notification occurs on all controllers associated with a registered host other than the host that issued the Reservation Register command.

8.8.5 Acquiring a Reservation

In order for a host to obtain a reservation on a namespace, it shall be a registrant of that namespace. A registrant obtains a reservation by executing a Reservation Acquire command, setting the Reservation Acquire Action (RACQA) field to 000b (Acquire), and supplying the current reservation key associated with the host in the Current Reservation Key (CRKEY) field. The CRKEY value shall match that used by the registrant to register with the namespace. If the key value does not match, then the command is aborted with status Reservation Conflict. If the host is not a registrant, then the command is aborted with a status of Reservation Conflict. A host may acquire a reservation without regard to its current reservation key value by setting the Ignore Existing Key (IEKEY) bit to '1' in the command.

Only one reservation is allowed at a time on a namespace. If a registrant attempts to obtain a reservation on a namespace that already has a reservation holder, then the command is aborted with status Reservation Conflict. If a reservation holder attempts to obtain a reservation of a different type on a namespace for which it already is the reservation holder, then the command is aborted with status Reservation Conflict. It is not an error if a reservation holder attempts to obtain a reservation of the same type on a namespace for which it already is the reservation holder. A reservation holder may preempt a reservation to change the reservation type.

8.8.6 Releasing a Reservation

Only a reservation holder may release in an orderly manner a reservation held on a namespace. A host releases a reservation by executing a Reservation Release command, setting the Reservation Release Action (RRELA) field to 000b (i.e., Release), setting the Reservation Type (RTYPE) field to the type of reservation being released, and supplying the current reservation key associated with the host in the Current Reservation Key (CRKEY) field. The CRKEY value shall match that used by the host to register with the namespace. If the key value doesn't match, then the command is aborted with status Reservation Conflict. A host may release a reservation without regard to its current reservation key value by setting the Ignore Existing Key (IEKEY) bit to '1' in the command. If the RTYPE field does not match the type of the current reservation, then the command completes with status Invalid Field in Command.

An attempt by a registrant to release a reservation using the Reservation Release command in the absence of a reservation held on the namespace or when the host is not the reservation holder shall cause the command to complete successfully, but shall have no effect on the controller or namespace.

When a reservation is released as a result of actions described in this section and the reservation type is not Write Exclusive or Exclusive Access, a reservation released notification occurs on all controllers in the NVM Subsystem hosts that are registrants except the host that issued the Reservation Release command.

8.8.7 Preempting a Reservation or Registration

A host that is a registrant may preempt a reservation and/or registration by executing a Reservation Acquire command, setting the Reservation Acquire Action (RACQA) field to 001b (Preempt), and supplying the current reservation key associated with the host in the Current Reservation Key (CRKEY) field. A host may preempt without regard to its current reservation key value by setting the Ignore Existing Key (IEKEY) bit to '1' in the Reservation Register command. The preempt actions that occur are dependent on the type of reservation held on the namespace, if any, and the value of the Preempt Reservation Key (PKEY) field in the command. If the host is not a registrant, then the command is aborted with a status of Reservation Conflict.

If the existing reservation type is Write Exclusive - All Registrants and not Exclusive Access - All Registrants, then the actions performed by the command depend on the value of the PRKEY field as follows. If the PRKEY field value matches the reservation key of the current reservation holder, then the following occur as an atomic operation: the reservation holder is unregistered, the reservation is released, and a new reservation is created of the type specified by the Reservation Type (RTYPE) field in the command for the host as the reservation key holder. If the PRKEY field value does not match that of the current reservation holder and is not equal to zero, then registrants whose reservation key matches the value of the PRKEY field are unregistered. If the PRKEY field value does not match that of the current reservation holder and is equal to zero, then the command is aborted with status Invalid Field in Command.

If the existing reservation type is Write Exclusive - All Registrants or Exclusive Access - All Registrants, then the actions performed by the command depend on the value of the PRKEY field as follows. If the PRKEY field value is zero, then the following occurs as an atomic operation: all registrants other than the host that issued the command are unregistered, the reservation is released, and a new reservation is created for the host of the type specified by the Reservation Type (RTYPE) field in the command. If the PRKEY value is non-zero, then registrants whose reservation key matches the value of the PRKEY field are unregistered.

If there is no reservation held on the namespace, then execution of the command causes registrants whose reservation key match the value of the PRKEY field to be unregistered.

A reservation holder may preempt itself using the above mechanism. When a host preempts itself the following occurs as an atomic operation: registration of the host is maintained, the reservation is released, and a new reservation is created for the host of the type specified by the RTYPE field.

A host may abort commands as a side effect of preempting a reservation by executing a Reservation Acquire command and setting the RACQA field to 010b (Preempt and Abort). The behavior of such a command is exactly the same as that described above with the RACQA field set to 001b (Preempt), except that commands that target the namespace are aborted by controllers associated with hosts whose reservation or registration is preempted. As with the Abort Admin command, abort as a side effect of preempting a reservation is best effort; the commands to abort may have already completed, currently be in execution, or may be deeply queued.

When a registrant is unregistered as a result of actions described in this section, then a registration preempted notification occurs on all controllers associated with a host that was unregistered other than the host that issued the Reservation Acquire command.

When the type of reservation held on a namespace changes as a result of actions described in this section, then a reservation released notification occurs on all controllers associated with hosts that remain registrants of the namespace except the host that issued the Reservation Acquire command.

8.8.8 Clearing a Reservation

A host that is a registrant may clear a reservation (i.e., force the release of a reservation held on the namespace and unregister all registrants) by executing a Reservation Release command, setting the Reservation Release Action (RRELA) field to 001b (i.e., Clear), and supplying the current reservation key associated with the host in the Current reservation Key (CRKEY) field. The CRKEY value shall match that used by the host to register with the namespace. If the value does not match, then the command is aborted with status Reservation Conflict. A host may clear a reservation without regard to its current reservation key value by setting the Ignore Existing Key (IEKEY) bit to '1' in the command. If the host is not a registrant, then the command is aborted with a status of Reservation Conflict. When a reservation is cleared the following occur as an atomic operation: any reservation held on the namespace is released, and all registrants are unregistered from the namespace.

When a reservation is released as a result of actions described in this section, then a reservation preempted notification occurs on all controllers in the NVM Subsystem that are associated with hosts registered with the namespace except the host that issued the Reservation Release command.

8.8.9 Reporting Reservation Status

A host may determine the current reservation status associated with a namespace by executing a Reservation Report command.

9 Error Reporting and Recovery

9.1 Command and Queue Error Handling

In the case of serious error conditions, like Completion Queue Invalid, the operation of the associated Submission Queue or Completion Queue may be compromised. In this case, host software should delete the associated Completion Queue and/or Submission Queue. The delete of a Submission Queue aborts all outstanding commands, and deletion of either queue type releases resources associated with that queue. Host software should recreate the Completion Queue and/or Submission Queue to then continue with operation.

In the case of serious error conditions for Admin commands, the entire controller should be reset using a Controller Reset. The entire controller should also be reset if a completion is not received for the deletion of a Submission Queue or Completion Queue.

For most command errors, there is not an issue with the Submission Queue and/or Completion Queue itself. Thus, host software and the controller should continue to process commands. It is at the discretion of host software whether to retry the failed command; the Retry bit in the Completion Queue Entry indicates whether a retry of the failed command may succeed.

9.2 Media and Data Error Handling

In the event that the requested operation could not be performed to the NVM media, the particular command is completed with a media error indicating the type of failure using the appropriate status code. During a read error within a command, (e.g. End-to-end Guard Check failure, Unrecovered Read Error, etc), the controller may choose to either stop the DMA transfer into the system memory or transfer the erroneous data to the system memory. The host shall ignore the data in the system memory locations for commands that complete with such error conditions.

Based on the value of the Limited Retry bit, the controller may apply all available error recovery means to complete the command.

9.3 System Memory Error Handling

System memory errors such as target abort, master abort, and parity may cause the controller to stop processing the currently executing command. These are serious errors that cannot be recovered from without host software intervention.

A master/target abort error occurs when host software has given a pointer to the host controller that does not exist in system memory. When this occurs, the host controller aborts the command with a Data Transfer Error status code.

9.4 Internal Device Error Handling

Device specific errors such as a DRAM failure or power loss notification errors indicate that a controller level failure has occurred during the processing of a command. The status code of the completion queue entry should indicate an Internal Device Error status code (if multiple error conditions exist, the lowest numerical value is returned). Host software shall ignore any data transfer associated with the command. The host may choose to re-submit the command or indicate an error to the higher level software.

9.5 Controller Fatal Status Condition

If the controller has a serious error condition and is unable to communicate with host software via completion queue entries in the Admin or I/O Completion Queues, then the controller may set the Controller Fatal Status (CSTS.CFS) field to '1'. This indicates to host software that a serious error

NVM Express 1.1

condition has occurred. When this condition occurs, host software should reset and then re-initialize the controller.

The Controller Fatal Status condition is not indicated with an interrupt. If host software experiences timeout conditions and/or repeated errors, then host software should consult the Controller Fatal Status (CSTS.CFS) field to determine if a more serious error has occurred.